

SCX-6555NX Series

# Multi Functional Printer User's Guide

imagine the possibilities

Thank you for purchasing a Samsung product.

**SAMSUNG**

# features of your new laser MFP

Thank you for purchasing this Samsung multifunctional product. Your machine provides printing, copying, scanning, and faxing functions.

With the machine, you can:

## SPECIAL FEATURES



Some features are optional. Please check the specifications sections. (See "Specifications" on page 115.)

### Print with excellent quality and speed

- You can print with a resolution of up to 1200 dpi Effective output. See *Software section*.
- Your machine prints A4-sized paper at up to 53 ppm and letter-sized paper at up to 55 ppm.
- For duplex printing, your machine prints A4-sized paper at up to 50 ipm and letter-sized paper at up to 52 ipm.

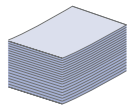

### Handle many different types of printable material

- The multi-purpose tray supports letterhead, envelopes, labels, transparencies, custom-sized media, postcards, and heavy paper. The multi-purpose tray holds up to 100 sheets of plain paper.
- The 520 sheet tray 1 and 520 sheet optional tray support plain paper in various sizes.
- The 2,100 sheet optional high tray support plain paper in various sizes.

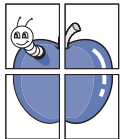

### Create professional documents

- Print Watermarks. You can customize your documents with words, such as "Confidential". See *Software section*.
- Print Posters. The text and pictures of each page of your document are magnified and printed across the sheet of paper and can then be taped together to form a poster. See *Software section*.
- You can use preprinted forms and letterhead with plain paper. See *Software section*.

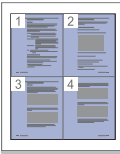

### Save time and money

- To save paper, you can print multiple pages on one single sheet of paper.
- This machine automatically conserves electricity by substantially reducing power consumption when not in use.
- To save paper, you can print on both sides of the paper (double-sided printing). See *Software section*.

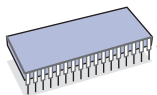

### Expand your machine's capacity

- Your machine has an extra memory slot to expand their memory. (See "Installing a memory DIMM" on page 112.)
- A Network interface enables network printing. Your machine comes with a built-in network interface, 10/100/1000 Base TX.
- Zoran IPS Emulation\* compatible with PostScript

Emulation\* (PS) enables PS printing.

### ZORAN® \* Zoran IPS Emulation compatible with PostScript 3

© Copyright 1995-2005, Zoran Corporation. All rights reserved. Zoran, the Zoran logo, IPS/PS3, and OneImage are trademarks of Zoran Corporation.

#### \* 136PS3 fonts

Contains UFST and MicroType from Monotype Imaging Inc.



### Print in various environments

- You can print with various operating system such as Windows, Linux and Macintosh systems.
- Your machine is equipped with a USB interface and a network interface.

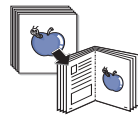

### Copy originals in several formats

- You can create a booklet using sequential 2-sided document production.
- There are special functions to erase punch holes, staple marks and newspaper background.
- The print quality and image size may be adjusted and enhanced at the same time.

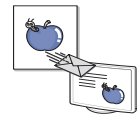

### Scan the originals and send it right away

- Quickly scan and send files to multiple destinations using, E-mail, SMB, FTP or Networks scanning.
- Simply use the touch screen keyboard to enter email addresses and send the scanned image immediately.
- Scan in color and use the precise compressions of JPEG, TIFF and PDF formats.

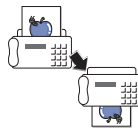

### Set a specific time to transmit a Fax (Optional)

- You can specify a certain time to transmit the fax and also send the fax to several stored destinations.
- After the transmission, the machine may print out the fax reports according to the setting.

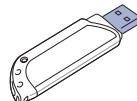

### Use USB memory devices

If you have a USB memory device, you can use it in various ways with your machine. (See "Using USB memory device" on page 70.)

### IPv6

This machine supports IPv6.

### Support XOA applications

The machine supports XOA custom applications.

- Regarding the XOA custom applications, please contact your XOA custom application provider.



## FEATURES BY MODELS

The machine is designed to support all of your document needs – from printing and copying, to more advanced networking solutions for your business. Basic features of this machine include;

FEATURES	SCX-6555NX
USB 2.0	●
USB Memory	●
DADF (Duplex Automatic Document Feeder)	●
Hard Disk	●
Network Interface Ethernet 10/100/1000 Base TX wired LAN	●
Duplex (2-sided) printing	●
FAX	○

(●: Included, ○: Optional, Blank: Not Available)



## ABOUT THIS USER'S GUIDE

This user's guide provides information about basic understanding of the machine as well as detailed explanation on each step during the actual usage. Both novice users and professional users can refer to this guide for installing and using the machine.

Some terms in this guide are used interchangeably, as below:



- Document is synonymous with original.
- Paper is synonymous with media, or print media.

The following table offers the conventions of this guide.

CONVENTION	DESCRIPTION	EXAMPLE
<b>Bold</b>	Used for texts on the display or actual prints on the machine.	<b>Start</b>
<b>Note</b>	Used to provide additional information or detailed specification of the machine function and feature.	 .The date format may differ from country to country
<b>Caution</b>	Used to give users information to protect the machine from possible mechanical damage or malfunction.	 Do not touch the green underside of the print cartridge.
>	Used to show the steps of selecting or pressing items in order. The example means; press <b>Copy</b> from the <b>Main</b> screen, press the <b>Advanced</b> tab, and then press <b>Clone Copy</b> .	<b>Copy</b> > the <b>Advanced</b> tab > <b>Clone Copy</b>
<b>Footnote</b>	Used to provide more detailed information on certain words or a phrase.	a. pages per minute
<b>(See page 1 for more information)</b>	Used to guide users to the reference page for the additional detailed information.	(See page1 for more information)

## FINDING MORE INFORMATION

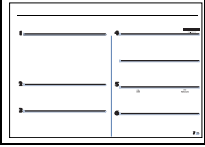
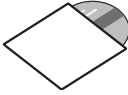
You can find information for setting up and using your machine from the following resources, either as a print-out or onscreen.











<p><b>Quick Install Guide</b></p> 	<p>Provides information on setting up your machine and this requires that you follow the instructions in the guide to prepare the machine.</p>
<p><b>Online User's Guide</b></p> 	<p>Provides you with step-by-step instructions for using your machine's full features, and contains information for maintaining your machine, troubleshooting, and installing accessories. This user's guide also contains <i>Software section</i> to provide you with information on how to print documents with your machine in various operating systems, and how to use the included software utilities.</p>
<p><b>Printer Driver Help</b></p> 	<p>Provides you with help information on printer driver properties and instructions for setting up the properties for printing. To access a printer driver help screen, click <b>Help</b> from the printer properties dialog box.</p>
<p><b>Samsung website</b></p>	<p>If you have Internet access, you can get help, support, printer drivers, manuals, and order information from the Samsung website, <a href="http://www.samsungprinter.com">www.samsungprinter.com</a>.</p>



# safety information

## IMPORTANT SAFETY SYMBOLS AND PRECAUTIONS













### What the icons and signs in this user manual mean:





 <b>WARNING</b>	Hazards or unsafe practices that may result in severe personal injury or death.
 <b>CAUTION</b>	Hazards or unsafe practices that may result in minor personal injury or property damage.
 <b>CAUTION</b>	To reduce the risk of fire, explosion, electric shock, or personal injury when using your laser MFP, follow these basic safety precautions:
	Do NOT attempt.
	Do NOT disassemble.YTU
	Do NOT touch.
	Follow directions explicitly.
	Unplug the power plug from the wall socket.
	Make sure the MFP is grounded to prevent electric shock.
	Call the service center for help.

**These warning signs are here to prevent injury to you and others.**

**Please follow them explicitly.**

**After reading this section, keep it in a safe place for future reference.**

-  1. Read and understand all instructions.
-  2. Use common sense whenever operating electrical appliances.
-  3. Follow all warnings and instructions marked on the machine and in the literature accompanying the machine.
-  4. If an operating instruction appears to conflict with safety information, heed the safety information. You may have misunderstood the operating instruction. If you cannot resolve the conflict, contact your sales or service representative for assistance.
-  5. Unplug the machine from the AC wall socket and/or telephone jack before cleaning. Do not use liquid or aerosol cleaners. Use only a damp cloth for cleaning.
-  6. Do not place the machine on an unstable cart, stand or table. It may fall, causing serious damage.
-  7. Your machine should never be placed on, near or over a radiator, heater, air conditioner or ventilation duct.
-  8. Do not allow anything to rest on the power. Do not locate your machine where the cords will be abused by persons walking on them.
-  9. Do not overload wall outlets and extension cords. This can diminish performance, and may result in the risk of fire or electric shock.
-  10. Do not allow pets to chew on the AC power, telephone or PC interface cords.
-  11. Never push objects of any kind into the machine through case or cabinet openings. They may touch dangerous voltage points, creating a risk of fire or shock. Never spill liquid of any kind onto or into the machine.
-   12. To reduce the risk of electric shock, do not disassemble the machine. Take it to a qualified service technician when repair work is required. Opening or removing covers may expose you to dangerous voltages or other risks. Incorrect reassembly could cause electric shock when the unit is subsequently used.

-  **13.** Unplug the machine from the telephone jack, PC and AC wall outlet and refer servicing to qualified service personnel under the following conditions:
- When any part of the power cord, plug or connecting cable is damaged or frayed.
  - If liquid has been spilled into the machine.
  - If the machine has been exposed to rain or water.
  - If the machine does not operate properly after instructions have been followed.
  - If the machine has been dropped, or the cabinet appears damaged.
  - If the machine exhibits a sudden and distinct change in performance.
-  **14.** Adjust only those controls covered by the operating instructions. Improper adjustment of other controls may result in damage, and may require extensive work by a qualified service technician to restore the machine to normal operation.
-  **15.** Avoid using this machine during a lightning storm. There may be a remote risk of electric shock from lightning. If possible, unplug the AC power and telephone cord for the duration of the lightning storm.
- 16.** The Power cord supplied with your machine should be used for safe operation. If you are using a cord which is longer than 2 m with 110 V machine, then it should be 16 AWG<sup>a</sup> or bigger.
- 17.** Use only No.26 AWG\* or larger telephone line cord.
-  **18.** SAVE THESE INSTRUCTIONS
-  **19.** This machine can be operated only in the country you have purchased. (Due to different voltage, frequency, telecommunication configuration and etc.)

a. AWG: American Wire Gauge

## LASER SAFETY STATEMENT

The printer is certified in the U.S. to conform to the requirements of DHHS 21 CFR, chapter 1 Subchapter J for Class I(1) laser products, and elsewhere is certified as a Class I laser product conforming to the requirements of IEC 825.

Class I laser products are not considered to be hazardous. The laser system and printer are designed so there is never any human access to laser radiation above a Class I level during normal operation, user maintenance or prescribed service condition.

### WARNING

Never operate or service the printer with the protective cover removed from Laser/Scanner assembly. The reflected beam, although invisible, can damage your eyes.

When using this product, these basic safety precautions should always be followed to reduce risk of fire, electric shock, and injury to persons:

	CAUTION - CLASS 3B LASER RADIATION WHEN OPEN AVOID EXPOSURE TO THE BEAM.
	DANGER - LASER RADIATION AVOID DIRECT EXPOSURE TO BEAM.
	DANGER - RADIATIONS INVISIBLES DU LASER EN CAS D'OUVERTURE. EVITER TOUTE EXPOSITION DIRECTE AU FAISCEAU.
	VORSICHT - UNSICHTBARE LASERSTRAHLUNG, WENN ABDECKUNG GEÖFFNET. NICHT DEM STRAHL AUSSETZEN.
	ATTENZIONE - RADIAZIONE LASER INVISIBILE IN CASO DI APERTURA, EVITARE L'ESPOSIZIONE AL FASCIO.
	PRECAUCIÓN - RADIACIÓN LASER INVISIBLE CUANDO SE ABRE. EVITAR EXPONERSE AL RAYO.
	PERIGO - RADIAÇÃO LASER INVISÍVEL AO ABRIR. EVITE EXPOSIÇÃO DIRECTA AO FEIXE.
	GEVAAR - ONZICHTBARE LASERSTRALLEN BIJ GEOPENDE KLEP. DEZE KLEP NIET OPENEN.
	ADVARSEL - USYNLIG LASERSTRÅLNING VED ÅBNING. UNDGÅ UDSAETTELSE FOR STRÅLNING.
	ADVARSEL - USYNLIG LASERSTRÅLNING NÅR DEKSEL ÅPNES. UNNGÅ EKSPONERING FOR STRÅLEN.
VARNING - OSYNLIG LASERSTRÅLNING NÅR DENNA DEL ÄR OPPEN. STRÅLEN ÄR FARLIG.	
VAROITUS - NÄKYMÄTÖNTÄ LASERSÄTEILYÄ AVATTAESSA. VARO SUORAA ALTISTUMISTA SÄTEELLE.	
<b>注意</b> - 严禁揭开此盖, 以免激光泄露灼伤	
주의 - 이 덮개를 열면 레이저광에 노출될 수 있으므로 주의하십시오.	

## OZONE SAFETY

---



During normal operation, this machine produces ozone. The ozone produced does not present a hazard to the operator. However, it is advisable that the machine be operated in a well ventilated area.

If you need additional information about ozone, request your nearest Samsung dealer.

## MERCURY SAFETY

---



Contains Mercury, Dispose According to Local, State or Federal Laws.(U.S.A. only)

## PERCHLORATE WARNING

---

This Perchlorate warning applies only to primary CR (Manganese Dioxide) Lithium coin cells in the product sold or distributed ONLY in California USA.

Perchlorate Material - special handling may apply.

See [www.dtsc.ca.gov/hazardouswaste/perchlorate](http://www.dtsc.ca.gov/hazardouswaste/perchlorate). (U.S.A. only)

## POWER SAVER

---



This printer contains advanced energy conservation technology that reduces power consumption when it is not in active use.

When the printer does not receive data for an extended period of time, power consumption is automatically lowered.

ENERGY STAR and the ENERGY STAR mark are registered U.S. marks.

For more information on the ENERGY STAR program see <http://www.energystar.gov>

## RECYCLING

---



Please recycle or dispose of the packaging material for this product in an environmentally responsible manner.

## CORRECT DISPOSAL OF THIS PRODUCT (WASTE ELECTRICAL & ELECTRONIC EQUIPMENT)

---



### **(Applicable in the European Union and other European countries with separate collection systems)**

This marking shown on the product or its literature, indicates that it should not be disposed with other household wastes at the end of its working life. To prevent possible harm to the environment or human health from uncontrolled waste disposal, please separate this from other types of wastes and recycle it responsibly to promote the sustainable reuse of material resources.

Household users should contact either the retailer where they purchased this product, or their local government office, for details of where and how they can take this item for environmentally safe recycling.

Business users should contact their supplier and check the terms and conditions of the purchase contract. This product should not be mixed with other commercial wastes for disposal.

## CORRECT DISPOSAL OF BATTERIES IN THIS PRODUCT

---



### **(Applicable in the European Union and other European countries with separate battery return systems.)**

This marking on the battery, manual or packaging indicates that the batteries in this product should not be disposed with other household waste at the end of their working life. Where marked, the chemical symbols Hg, Cd or Pb indicate that the battery contains mercury, cadmium or lead above the reference levels in EC Directive 2006/66. If batteries are not properly disposed of, these substances can cause harm to human health or the environment.

To protect natural resources and to promote material reuse, please separate batteries from other types of waste and recycle them through your local, free battery return system.

## RADIO FREQUENCY EMISSIONS

---

### FCC Information to the User

This device complies with Part 15 of the FCC Rules. Operation is subject to the following two conditions:

- This device may not cause harmful interference, and
- This device must accept any interference received, including interference that may cause undesired operation.

This equipment has been tested and found to comply with the limits for a Class A digital device, pursuant to Part 15 of the FCC Rules. These limits are designed to provide reasonable protection against harmful interference in a residential installation. This equipment generates, uses and can radiate radio frequency energy and, if not installed and used in accordance with the instructions, may cause harmful interference to radio communications. However, there is no guarantee that interference will not occur in a particular installation. If this equipment does cause harmful interference to radio or television reception, which can be determined by turning the equipment off and on, the user is encouraged to try to correct the interference by one or more of the following measures:

- Reorient or relocate the receiving antenna.
- Increase the separation between the equipment and receiver.
- Connect the equipment into an outlet on a circuit different from that to which the receiver is connected.
- Consult the dealer or experienced radio TV technician for help.



Change or modifications not expressly approved by the manufacturer responsible for compliance could void the user's authority to operate the equipment.

### Canadian Radio Interference Regulations

This digital apparatus does not exceed the Class A limits for radio noise emissions from digital apparatus as set out in the interference-causing equipment standard entitled "Digital Apparatus", ICES-003 of the Industry and Science Canada.

Cet appareil numérique respecte les limites de bruits radioélectriques applicables aux appareils numériques de Classe A prescrites dans la norme sur le matériel brouilleur: "Appareils Numériques", ICES-003 édictée par l'Industrie et Sciences Canada.

## FAX BRANDING

---

The Telephone Consumer Protection Act of 1991 makes it unlawful for any person to use a computer or other electronic device to send any message via a telephone facsimile machine unless such message clearly contains in a margin at the top or bottom of each transmitted page or on the first page of the transmission the following information:

- (1) the date and time of transmission
- (2) identification of either business, business entity or individual sending the message; and
- (3) telephone number of either the sending machine, business, business entity or individual.

The Telephone Company may make changes in its communications facilities, equipment operations or procedures where such action is reasonably required in the operation of its business and is not inconsistent with the rules and regulations in FCC Part 68. If such changes can be reasonably expected to render any customer terminal equipment incompatible with telephone company communications facilities, or require modification or alteration of such terminal equipment, or otherwise materially affect its use or performance, the customer shall be given adequate notice in writing, to allow the customer an opportunity to maintain uninterrupted service

## RINGER EQUIVALENCE NUMBER

---

The Ringer Equivalence Number and FCC Registration Number for this machine may be found on the label located on the bottom or rear of the machine. In some instances you may need to provide these numbers to the telephone company.

The Ringer Equivalence Number (REN) is a measure of the electrical load placed on the telephone line, and is useful for determining whether you have "overloaded" the line. Installing several types of equipment on the same telephone line may result in problems making and receiving telephone calls, especially ringing when your line is called. The sum of all Ringer Equivalence Numbers of the equipment on your telephone line should be less than five in order to assure proper service from the telephone company. In some cases, a sum of five may not be usable on your line. If any of your telephone equipment is not operating properly, you should immediately remove it from your telephone line, as it may cause harm to the telephone network.

The equipment complies with Part 68 of the FCC rules and the requirements adopted by the ACTA. On the rear of this equipment is a label that contains, among other information, a product identifier in the format US:AAAEQ##TXXXX. If requested, this number must be provided to the telephone company.



FCC Regulations state that changes or modifications to this equipment not expressly approved by the manufacturer could void the user's authority to operate this equipment. In the event that terminal equipment causes harm to the telephone network, the telephone company should notify the customer that service may be stopped. However, where prior notice is impractical, the company may temporarily cease service, providing that they:

- a) promptly notify the customer.
- b) give the customer an opportunity to correct the equipment problem.
- c) inform the customer of the right to bring a complaint to the Federal Communication Commission pursuant to procedures set out in FCC Rules and Regulations Subpart E of Part 68.

### **You should also know that:**

- Your machine is not designed to be connected to a digital PBX system.
- If you intend to use a computer modem or fax modem on the same phone line as your machine, you may experience transmission and reception problems with all the equipment. It is recommended that no other equipment, except for a regular telephone, share the line with your machine.
- If your area experiences a high incidence of lightning or power surges, we recommend that you install surge protectors for both the power and the telephone lines. Surge protectors can be purchased from your dealer or telephone and electronic specialty stores.
- When programming emergency numbers and/or making test calls to emergency numbers, use a non-emergency number to advise the emergency service dispatcher of your intentions. The dispatcher will give you further instructions on how to actually test the emergency number.
- This machine may not be used on coin service or party lines.
- This machine provides magnetic coupling to hearing aids.

You may safely connect this equipment to the telephone network by means of a standard modular jack, USOC RJ-11C.

## **REPLACING THE FITTED PLUG (FOR UK ONLY)**

---

### **Important**

The mains lead for this machine is fitted with a standard (BS 1363) 13 amp plug and has a 13 amp fuse. When you change or examine the fuse, you must re-fit the correct 13 amp fuse. You then need to replace the fuse cover. If you have lost the fuse cover, do not use the plug until you have another fuse cover.

Please contact the people from you purchased the machine.

The 13 amp plug is the most widely used type in the UK and should be suitable. However, some buildings (mainly old ones) do not have normal 13 amp plug sockets. You need to buy a suitable plug adaptor. Do not remove the moulded plug.



**If you cut off the moulded plug, get rid of it straight away.  
You cannot rewire the plug and you may receive an electric shock if you plug it into a socket.**



### **Important warning:**

**You must earth this machine.**

The wires in the mains lead have the following color code:

- Green and Yellow: Earth
- Blue: Neutral
- Brown: Live

If the wires in the mains lead do not match the colors marked in your plug, do the following:

You must connect the green and yellow wire to the pin marked by the letter "E" or by the safety 'Earth symbol' or colored green and yellow or green.

You must connect the blue wire to the pin which is marked with the letter "N" or colored black.

You must connect the brown wire to the pin which is marked with the letter "L" or colored red.

You must have a 13 amp fuse in the plug, adaptor, or at the distribution board.



## DECLARATION OF CONFORMITY (EUROPEAN COUNTRIES)

---



### Approvals and Certifications

The CE marking applied to this product symbolizes Samsung Electronics Co., Ltd. Declaration of Conformity with the following applicable 93/68/EEC Directives of the European Union as of the dates indicated:

The declaration of conformity may be consulted at [www.samsung.com/printer](http://www.samsung.com/printer), go to Support > Download center and enter your printer name to browse the EuDoC.

**January 1, 1995:** Council Directive 2006/95/EC Approximation of the laws of the member states related to low voltage equipment.

**January 1, 1996:** Council Directive 2004/108/EC (92/31/EEC), approximation of the laws of the Member States related to electromagnetic compatibility.

**March 9, 1999:** Council Directive 1999/5/EC on radio equipment and telecommunications terminal equipment and the mutual recognition of their conformity. A full declaration, defining the relevant Directives and referenced standards can be obtained from your Samsung Electronics Co., Ltd. representative.

### EC Certification

#### Certification to 1999/5/EC Radio Equipment & Telecommunications Terminal Equipment Directive (FAX)

This Samsung product has been self-certified by Samsung for pan-European single terminal connection to the analogue public switched telephone network (PSTN) in accordance with Directive 1999/5/EC. The product has been designed to work with the national PSTNs and compatible PBXs of the European countries:

In the event of problems, you should contact the Euro QA Lab of Samsung Electronics Co., Ltd. in the first instance.

The product has been tested against TBR21. To assist in the use and application of terminal equipment which complies with this standard, the European Telecommunication Standards Institute (ETSI) has issued an advisory document (EG 201 121) which contains notes and additional requirements to ensure network compatibility of TBR21 terminals. The product has been designed against, and is fully compliant with, all of the relevant advisory notes contained in this document.

## OPENSSL LICENSE

---

Copyright (c) 1998-2001 The OpenSSL Project. All rights reserved.

Redistribution and use in source and binary forms, with or without modification, are permitted provided that the following conditions are met:

1. Redistributions of source code must retain the above copyright notice, this list of conditions and the following disclaimer.
2. Redistributions in binary form must reproduce the above copyright notice, this list of conditions and the following disclaimer in the documentation and/or other materials provided with the distribution.
3. All advertising materials mentioning features or use of this software must display the following acknowledgment: "This product includes software developed by the OpenSSL Project for use in the OpenSSL Toolkit. (<http://www.openssl.org/>)"
4. The names "OpenSSL Toolkit" and "OpenSSL Project" must not be used to endorse or promote products derived from this software without
5. prior written permission. For written permission, please contact [openssl-core@openssl.org](mailto:openssl-core@openssl.org).
6. Products derived from this software may not be called "OpenSSL" nor may "OpenSSL" appear in their names without prior written permission of the OpenSSL Project.
7. Redistributions of any form whatsoever must retain the following acknowledgment: "This product includes software developed by the OpenSSL Project for use in the OpenSSL Toolkit (<http://www.openssl.org/>)"

THIS SOFTWARE IS PROVIDED BY THE OpenSSL PROJECT ``AS IS'' AND ANY EXPRESSED OR IMPLIED WARRANTIES, INCLUDING, BUT NOT LIMITED TO, THE IMPLIED WARRANTIES OF MERCHANTABILITY AND FITNESS FOR A PARTICULAR PURPOSE ARE DISCLAIMED. IN NO EVENT SHALL THE OpenSSL PROJECT OR ITS CONTRIBUTORS BE LIABLE FOR ANY DIRECT, INDIRECT, INCIDENTAL, SPECIAL, EXEMPLARY, OR CONSEQUENTIAL DAMAGES (INCLUDING, BUT NOT LIMITED TO, PROCUREMENT OF SUBSTITUTE GOODS OR SERVICES; LOSS OF USE, DATA, OR PROFITS; OR BUSINESS INTERRUPTION) HOWEVER CAUSED AND ON ANY THEORY OF LIABILITY, WHETHER IN CONTRACT, STRICT LIABILITY, OR TORT (INCLUDING NEGLIGENCE OR OTHERWISE) ARISING IN ANY WAY OUT OF THE USE OF THIS SOFTWARE, EVEN IF ADVISED OF THE POSSIBILITY OF SUCH DAMAGE.

This product includes cryptographic software written by Eric Young ([eay@cryptsoft.com](mailto:eay@cryptsoft.com)). This product includes software written by Tim Hudson ([tjh@cryptsoft.com](mailto:tjh@cryptsoft.com)).

## ORIGINAL SSLEAY LICENSE

---

Copyright (C) 1995-1998 Eric Young (eay@cryptsoft.com) All rights reserved.

This package is an SSL implementation written by Eric Young (eay@cryptsoft.com). The implementation was written so as to conform with Netscapes SSL.

This library is free for commercial and non-commercial use as long as the following conditions are aheared to. The following conditions apply to all code found in this distribution, be it the RC4, RSA, lhash, DES, etc., code; not just the SSL code. The SSL documentation included with this distribution is covered by the same copyright terms except that the holder is Tim Hudson (tjh@cryptsoft.com). Copyright remains Eric Young's, and as such any Copyright notices in the code are not to be removed. If this package is used in a product, Eric Young should be given attribution as the author of the parts of the library used. This can be in the form of a textual message at program startup or in documentation (online or textual) provided with the package.

Redistribution and use in source and binary forms, with or without modification, are permitted provided that the following conditions are met:

1. Redistributions of source code must retain the copyright notice, this list of conditions and the following disclaimer.
2. Redistributions in binary form must reproduce the above copyright notice, this list of conditions and the following disclaimer in the documentation and/or other materials provided with the distribution.
3. All advertising materials mentioning features or use of this software must display the following acknowledgement: "This product includes cryptographic software written by Eric Young (eay@cryptsoft.com)" The word 'cryptographic' can be left out if the rouines from the library being used are not cryptographic related:-).
4. If you include any Windows specific code (or a derivative thereof) from the apps directory (application code) you must include an acknowledgement: "This product includes software written by Tim Hudson (tjh@cryptsoft.com)"

THIS SOFTWARE IS PROVIDED BY ERIC YOUNG ``AS IS" AND ANY EXPRESS OR IMPLIED WARRANTIES, INCLUDING, BUT NOT LIMITED TO, THE IMPLIED WARRANTIES OF MERCHANTABILITY AND FITNESS FOR A PARTICULAR PURPOSE ARE DISCLAIMED. IN NO EVENT SHALL THE AUTHOR OR CONTRIBUTORS BE LIABLE FOR ANY DIRECT, INDIRECT, INCIDENTAL, SPECIAL, EXEMPLARY, OR CONSEQUENTIAL DAMAGES (INCLUDING, BUT NOT LIMITED TO, PROCUREMENT OF SUBSTITUTE GOODS OR SERVICES; LOSS OF USE, DATA, OR PROFITS; OR BUSINESS INTERRUPTION) HOWEVER CAUSED AND ON ANY THEORY OF LIABILITY, WHETHER IN CONTRACT, STRICT LIABILITY, OR TORT (INCLUDING NEGLIGENCE OR OTHERWISE) ARISING IN ANY WAY OUT OF THE USE OF THIS SOFTWARE, EVEN IF ADVISED OF THE POSSIBILITY OF SUCH DAMAGE.

The licence and distribution terms for any publically available version or derivative of this code cannot be changed. i.e. this code cannot simply be copied and put under another distribution licence [including the GNU Public Licence.]

	<b>2</b>	<b>Features of your new laser MFP</b>
	<b>5</b>	<b>Safety Information</b>
<b>INTRODUCTION</b>	<b>18</b>	<b>Printer overview</b>
	18	Front view
	18	Rear view
	<b>19</b>	<b>Control panel overview</b>
	<b>20</b>	<b>Introducing the touch screen and useful buttons</b>
	20	Touch screen
	20	Machine Setup button
	20	Job Status button
	<b>21</b>	<b>XOA button</b>
	21	Power Saver Button
	21	Interrupt button
	<b>21</b>	<b>Managing your machine from the website</b>
	21	To access SyncThru™ Web Service:
	<b>22</b>	<b>Understanding the Status LED</b>
	<b>23</b>	<b>Menu overview</b>
	23	Main screen
	23	Machine Setup button
	24	Job Status button
	<b>25</b>	<b>Supplied software</b>
	<b>25</b>	<b>Printer driver features</b>
	25	Printer driver
<b>GETTING STARTED</b>	<b>26</b>	<b>Setting up the hardware</b>
	<b>26</b>	<b>Setting up the network</b>
	26	Supported operating systems
	27	Configuring network protocol via the machine
	<b>27</b>	<b>System requirements</b>
	27	Windows
	28	Macintosh
	28	Linux
	<b>28</b>	<b>Installing the software</b>
	<b>29</b>	<b>Machine's basic settings</b>
	29	Altitude adjustment
	30	Setting the authentication password
	30	Setting the date and time
	30	Changing the display language
	30	Setting job timeout
	30	Using energy saving feature
	30	Setting the default tray and paper
	31	Changing the default settings
	31	Using the SetIP program
	<b>32</b>	<b>Understanding the keyboard</b>
<b>LOADING ORIGINALS AND PRINT MEDIA</b>	<b>33</b>	<b>Loading originals</b>
	33	On the scanner glass
	33	In the DADF
	<b>34</b>	<b>Selecting print media</b>
	35	Specification on print media
	36	Media sizes supported in each mode
	36	Guidelines for special print media
	<b>37</b>	<b>Changing the size of the paper in the paper tray</b>
	<b>38</b>	<b>Loading paper</b>

- 38 Loading paper in tray 1, optional tray or optional high capacity feeder
- 39 In the multi-purpose tray
- 40 Setting the paper size and type**

## COPYING

41

- 41 Understanding the Copy screen**
- 41 Basic tab
- 41 Advanced tab
- 42 Image tab
- 42 Copying originals**
- 42 Changing the settings for each copy**
- 42 Changing the size of originals
- 43 Reducing or enlarging copies
- 43 Copying on both sides of originals (Duplex)
- 44 Deciding the form of copy output (Collated / Staple)
- 44 Selecting the type of originals
- 44 Changing the darkness
- 44 Using special copy features**
- 44 ID card copying
- 45 Copying ID with the manual ID copy option
- 45 2-up or 4-up copying (N-up)
- 45 Poster copying
- 46 Clone copying
- 46 Book copying
- 46 Booklet copying
- 47 Cover copying
- 47 Transparency copying
- 47 Erasing edges
- 47 Erasing background images
- 47 Shifting margins
- 48 Watermark copying
- 48 Overlay copying
- 48 Auto crop copying
- 48 Multi-Bin

## SCANNING

49

- 49 Scanning basics**
- 49 Understanding the Scan screen**
- 50 Basic tab
- 50 Advanced tab
- 50 Image tab
- 51 Output tab
- 51 Scanning originals and sending through email (Scan to Email)**
- 51 Sending a scanned image to several destinations as an email attachment
- 51 Storing email addresses
- 52 Entering email addresses by the address book
- 52 Entering email addresses by the keyboard
- 53 Using Scan and Fax Manager 2**
- 53 **Set Scan Button** tab
- 53 Scan Assistant
- 54 Scanning by a network connection**
- 54 Preparing for network scanning
- 56 Scanning originals and sending via SMB/FTP (Scan to Server)**
- 56 Preparation for scanning to SMB/FTP
- 56 Scanning and sending to SMB/FTP server
- 56 Changing the scan feature settings**
- 56 Duplex
- 56 Resolution
- 57 Original Size

	57	Original Type
	57	Color Mode
	57	Darkness
	57	Erase Background
	58	Scan to Edge
	58	Quality
	58	File Format
	58	Scan Preset
<b>BASIC PRINTING</b>	<b>59</b>	<b>Printing a document</b>
	<b>59</b>	<b>Canceling a print job</b>
	59	
<b>FAXING (OPTIONAL)</b>	<b>60</b>	<b>Preparing to fax</b>
	<b>60</b>	<b>Understanding the Fax screen</b>
	60	Basic tab
	61	Advanced tab
	61	Image tab
	<b>61</b>	<b>Sending a fax</b>
	61	Setting the fax header
	61	Sending a fax
	62	Sending a fax manually (On Hook Dial)
	62	Automatic resending
	62	Redialing the last number
	62	Delaying a fax transmission
	63	Sending a priority fax
	<b>63</b>	<b>Receiving a fax</b>
	63	Changing the receive modes
	63	Receiving manually in Telephone mode
	63	Receiving automatically in Answering Machine/Fax mode
	63	Receiving faxes manually using an extension telephone
	63	Receiving in secure receiving mode
	64	Receiving faxes in memory
	<b>64</b>	<b>Adjusting the document settings</b>
	64	Duplex
	64	Resolution
	64	Original Type
	64	Darkness
	64	Erase Background
	64	Color Mode
	<b>64</b>	<b>Setting up a fax phonebook</b>
	65	Storing individual fax numbers (Speed Dial No.)
	65	Storing Group fax numbers (Group No.)
	65	Setting up a fax phonebook using SyncThru Web Service
	<b>65</b>	<b>Using the polling option</b>
	66	Storing the originals for polling
	66	Printing (Deleting) the polling document
	66	Polling a remote fax
	66	Polling from a remote Mailbox
	<b>66</b>	<b>Using Mailbox</b>
	66	Creating Mailbox
	67	Storing originals in Mailbox
	67	Faxing to a remote Mailbox
	<b>68</b>	<b>Printing a report after sending a fax</b>
	<b>68</b>	<b>Sending a fax in toll save time</b>



	<b>68</b>	<b>Adding documents to a reserved delay fax job</b>
	<b>68</b>	<b>Forwarding a received fax to other destination</b>
	68	Forwarding a sent fax to other destination by a fax
	69	Forwarding a received fax to other destination by a fax
	69	Forwarding a sent fax to other destination by an email
	69	Forwarding a received fax to other destination by an email
	69	Forwarding a sent fax to other destination by server
	69	Forwarding a received fax to other destination by server
	<b>69</b>	<b>Setting up the end Fax tone</b>
<b>MACHINE STATUS AND ADVANCED SETUP</b>	<b>70</b>	<b>Machine Setup</b>
	70	Machine Status screen
	70	Admin Setting screen
	<b>71</b>	<b>Browsing the machine's status</b>
	<b>71</b>	<b>General settings</b>
	<b>73</b>	<b>Copy Setup</b>
	<b>73</b>	<b>Fax Setup</b>
	<b>75</b>	<b>Network Setup</b>
	<b>75</b>	<b>Authentication</b>
	<b>76</b>	<b>Optional Service</b>
	<b>76</b>	<b>Document Box Management</b>
	<b>77</b>	<b>Printing a report</b>
<b>USING USB MEMORY DEVICE</b>	<b>78</b>	<b>About USB memory</b>
	<b>78</b>	<b>Understanding the USB screen</b>
	<b>78</b>	<b>Plugging in a USB memory device</b>
	<b>79</b>	<b>Scanning to an USB memory device</b>
	79	Scanning
	<b>79</b>	<b>Scan to USB</b>
	79	Basic tab
	79	Advanced tab
	79	Image tab
	79	Output tab
	<b>80</b>	<b>Changing the scan feature settings</b>
	80	Duplex
	80	Resolution
	80	Original Size
	80	Original Type
	80	Color Mode
	81	Darkness
	81	Erase Background
	81	Scan to Edge
	81	Quality
	81	Scan Preset
	81	File Format
	81	File Policy
	<b>82</b>	<b>Printing from a USB memory device</b>
	82	To print a document from a USB memory device:
<b>MAINTENANCE</b>	<b>83</b>	<b>Printing a machine report</b>
	<b>83</b>	<b>Monitoring the supplies life</b>
	<b>83</b>	<b>Finding the serial number</b>
	<b>83</b>	<b>Sending the imaging unit reorder notification</b>
	<b>83</b>	<b>Sending the toner reorder notification</b>
	<b>84</b>	<b>Checking Document Box</b>



# contents

---

<b>SPECIFICATIONS</b>	
115	<b>115 General specifications</b>
	<b>115 Printer specifications</b>
	<b>116 Copier specifications</b>
	<b>116 Scanner specifications</b>
	<b>116 Facsimile specifications (optional)</b>

## **GLOSSARY**

117

## **INDEX**

124

# introduction

These are the main components of your machine:

## This chapter includes

- Printer overview
- Control panel overview
- Introducing the touch screen and useful buttons
- Managing your machine from the website
- Understanding the Status LED
- Menu overview
- Supplied software
- Printer driver features

## PRINTER OVERVIEW

### Front view

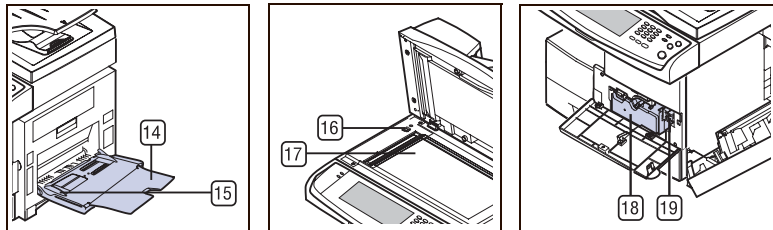
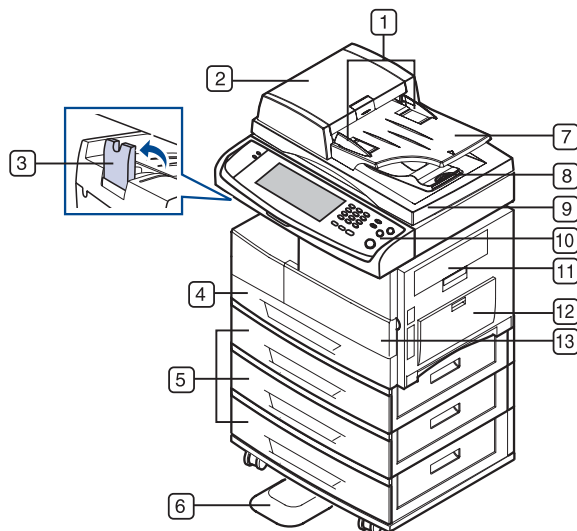

1	DADF document width guides	11	Side cover
2	DADF cover	12	Multi-purpose tray
3	Output support	13	Front cover
4	Tray 1	14	Multi-purpose tray extension
5	Optional tray <sup>a</sup>	15	Multi-purpose tray paper width guides
6	Stand <sup>a</sup>	16	Scanner lock switch
7	DADF document input tray	17	Scanner glass

8	DADF document output tray	18	toner cartridge
9	scanner lid	19	imaging unit
10	Control panel		

a. The symbol <sup>a</sup> is a mark for the optional device.

### Rear view

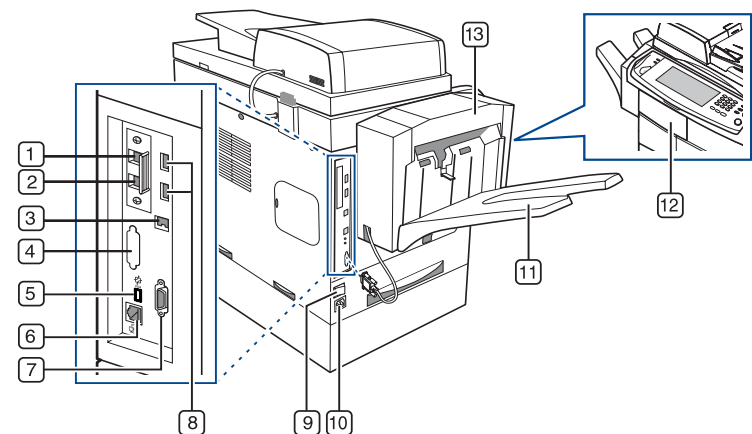

1	Extension telephone socket (EXT) <sup>a</sup>	8	USB memory port
2	Telephone line socket (LINE) <sup>a</sup>	9	Power switch
3	USB port	10	Power receptacle
4	dummy for FDI (Foreign Device Interface) <sup>a</sup>	11	Finisher output tray (Stacker & Stapler) <sup>a</sup>
5	XOA port	12	finisher cover (Stacker & Stapler) <sup>a</sup>
6	network port	13	finisher (Stacker & Stapler) <sup>a</sup>
7	15-pin Finisher connection (Stacker & Stapler) <sup>a</sup>		

a. The symbol <sup>a</sup> is a mark for the optional device.

## CONTROL PANEL OVERVIEW

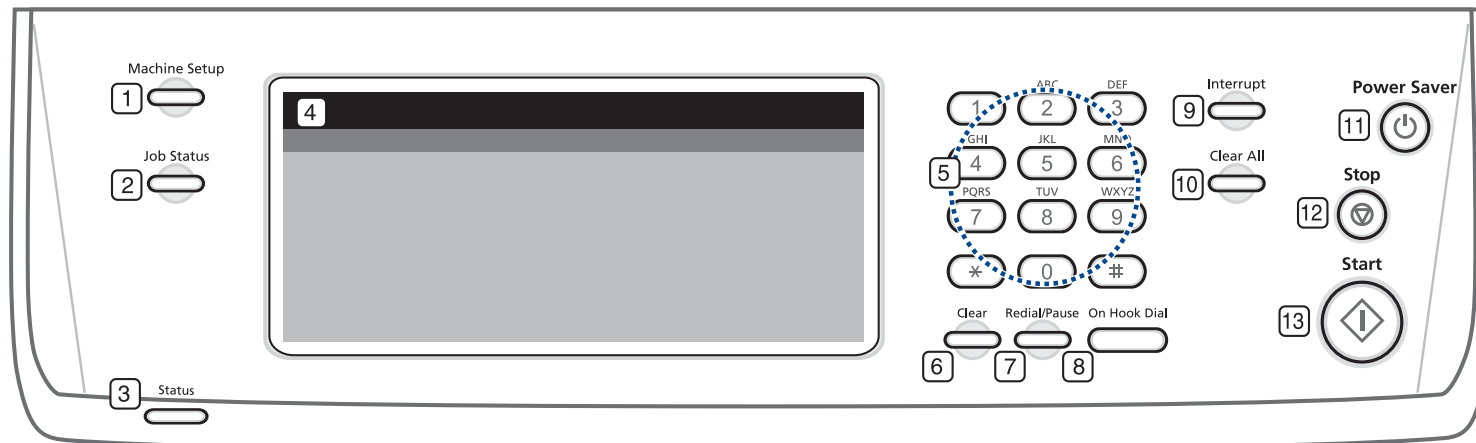

1	<b>Machine Setup</b>	Leads you to the machine setup and advanced settings. (See "Machine Setup" on page 75.)
2	<b>Job Status</b>	Shows the jobs currently running, queued jobs or completed jobs.
3	<b>Status</b>	Shows the status of your machine. (See "Managing your machine from the website" on page 21.)
4	<b>Display screen</b>	Displays the current machine status and prompts during an operation. You can set menus easily using the touch screen.
5	<b>number keypad</b>	Dials fax number, and enters the number value for document copies or other options.
6	<b>Clear</b>	Deletes characters in the edit area.
7	<b>Redial/Pause</b>	In standby mode, redials the last number, or in edit mode, inserts a pause into a fax number.
8	<b>On Hook Dial</b>	Engages the telephone line.
9	<b>Interrupt</b>	Stops a job in process to do an urgent copy job.
10	<b>Clear All</b>	Reverts the current settings to the default values.
11	<b>Power Saver</b>	Sends the machine into the power saver mode. (See "Using energy saving feature" on page 30.)
12	<b>Stop</b>	Stops an operation at any time. The pop up window appears on the screen showing the current job that the user can stop or resume.
13	<b>Start</b>	Starts a job.

-  All illustrations on this user's guide may differ from your machine depending on its options or models.
- When you use the touch screen, use your finger only. The screen may be damaged with a sharpened pen or else.







# INTRODUCING THE TOUCH SCREEN AND USEFUL BUTTONS

## Touch screen

The touch screen allows for user-friendly operation of the machine. Once you press the home icon (  ) on the screen, it shows the **Main** screen.



- : Shows Help. You can find the explanation by feature contents.
  - **XOA**: Enters the **XOA** menu. In order to use this menu, XOA applications should be installed. For more information, contact your local Samsung dealer or the retailer where you purchased your machine.
  - **Copy**: Enters the **Copy** menu.
  - **Fax**: Enters the **Fax** menu. (Optional)
  - **Scan**: Enters **Scan to Email**, **Scan to PC**, **Scan to Server** menu.
  - **Document Box**: Enters the **Document Box** menu. (See "Checking Document Box" on page 84.)
  - **USB**: When USB memory is inserted into the USB memory port on your machine, USB icon shows on the display screen.
  - **Logout**: Logs out from the currently logged in account.
  - **Toner Info.**: Shows amount of toner used.
  - **LCD Brightness**: Adjusts the brightness of the touch screen.
  - : To change the language that appears on the display.
  -  **USB**: guides you to remove the USB memory devices from the machine. Follow the instruction on the LCD. This icon appears only when you connect an USB memory module.
-  • Icons shown on the display screen such as **Fax** may be grayed out, depending on the optional kit or program installed in your machine.
- To switch the display screen and see other available icons, press the right arrow on the display screen.

## Machine Setup button

When you press this button, you can browse current machine settings or change machine values. (See "Machine Setup" on page 75.)



- : This button allows you to move to **Copy**, **Fax**, **Scan**, **Document Box** menu directly.
- **Machine Status**: Shows the current status of the machine.
- **Admin Setting**: Allows an administrator to set up the machine.
- **Tray Management**: Shows the currently installed tray and their status. You can also change the paper settings for each tray.
- **Usage Page Report**: You can print the report on the amount of printouts depending on the paper size and type.

## Job Status button

When you press this button, the screen shows the lists of currently running jobs, queued jobs and completed jobs.

No.	Job Name	Status	User	Job Type
000	Copy Job:JobName_0	Scanning	JobOwner_0	Copy
001	Copy Job:JobName_1	Scanning	JobOwner_1	Copy
002	Copy Job:JobName_2	Scanning	JobOwner_2	Copy
003	Copy Job:JobName_3	Scanning	JobOwner_3	Copy
004	Copy Job:JobName_4	Scanning	JobOwner_4	Copy
005	Copy Job:JobName_5	Scanning	JobOwner_5	Copy

- **Current Job** tab: Shows the list of jobs in progress and pending.
- **Completed Job** tab: Provides the list of completed jobs.
- **Active Notice** tab: Displays any error codes that have occurred.
- **No.:** Gives the order of jobs. The job in No. 001 is currently in progress.
- **Job Name**: Shows job information like name and type.
- **Status**: Gives the current status of each job.
- **User**: Provides user name, mainly computer name.
- **Job Type**: Displays details of the active job, such as job type, recipient phone number and other information.
- **Delete**: Removes the selected job from the list.
- **Delete All**: Removes all the jobs from the list.
- **Detail**: Shows the detailed information of the selected option on the **Active Notice** list.

## XOA button

When you press this button, you can use the XOA applications from the display screen. Before using the XOA applications, they should be installed. If the **XOA** button is not displayed, make sure that the machine gets XOA license. For more information, contact your local Samsung dealer or the retailer where you purchased your machine.



 If the message asking **Auth. ID and Password**, it means the network administrator has set the authentication in **SyncThru Web Service**. (See "Managing your machine from the website" on page 21.)

## Power Saver Button

When the machine is not in use, save electricity with the provided power save mode. Pressing this button puts the machine into power save mode. (See "Using energy saving feature" on page 30.)

If you press this button for more than two seconds, a window appears, requesting that you turn the power off. If you choose **Yes**, the power is turned off. This button can also be used to turn the button on.

STATUS		DESCRIPTION
Off		The machine is not in the power save mode.
Blue	On	The machine is in the low power save mode.
	Blink	The machine is in the power save mode.

## Interrupt button

When you press this button, the machine goes into interrupt mode which means it stops a printing job for urgent copy job. When the urgent copy job completes, the previous printing job continues.

STATUS		DESCRIPTION
Off		The machine is not in interrupt printing mode.
Blue	On	The machine is in interrupt printing mode.

 Interrupt mode is resumed at default value (Off) after the machine is shut down or reset.

## MANAGING YOUR MACHINE FROM THE WEBSITE

If you have connected your machine to a network and set up TCP/IP network parameters correctly, you can manage the machine via Samsung's **SyncThru™ Web Service**, an embedded web server. Use **SyncThru™ Web Service** to:

- View the machine's device information and check its current status.
- Change TCP/IP parameters and set up other network parameters.
- Change the printer properties.
- Set the machine to send email notifications to let you know the machine's status.
- Get support for using the machine.

### To access SyncThru™ Web Service:

1. Start a web browser, such as Internet Explorer, from Windows.
2. Enter the machine IP address (<http://xxx.xxx.xxx.xxx>) in the address field and press the **Enter** key or click **Go**.  
Your machine's embedded website opens.
3. Click **Login**.  
The log-in window appears.
4. Enter the administrator's ID and password then click **Login**.
  -  • Enter the same administrator's ID and password to the touch screen.
  - If you do not login with administrator's ID and password, you can see the machine's information only.
5. Change the settings as you want such as the machine settings, network parameters, etc.

## UNDERSTANDING THE STATUS LED

When the problem occurs, the **Status** LED indicates the machine's condition by the light color of it's action.

STATUS		DESCRIPTION
<b>Off</b>		<ul style="list-style-type: none"><li>• The machine is off-line.</li><li>• The machine is in power save mode. When data is received, or any button is pressed, it switches to on-line automatically.</li></ul>
<b>Green</b>	<b>Blinking</b>	<ul style="list-style-type: none"><li>• When the backlight slowly blinks, the machine is receiving data from the computer.</li><li>• When the backlight blinks rapidly, the machine is printing data.</li></ul>
	<b>On</b>	The machine is on-line and can be used.
<b>Red</b>	<b>Blinking</b>	<ul style="list-style-type: none"><li>• A minor error has occurred and the machine is waiting the error to be cleared. Check the display message. When the problem is cleared, the machine resumes.</li><li>• The toner cartridge is low. Order a new toner cartridge. You can temporarily improve print quality by redistributing the toner. (See "Replacing the toner cartridge" on page 85.)</li></ul>
	<b>On</b>	<ul style="list-style-type: none"><li>• The imaging unit is totally out of lifespan. Remove the old imaging unit and install a new one. (See "Replacing the imaging unit" on page 87.)</li><li>• The toner cartridge is totally empty. Remove the old toner cartridge and install a new one. (See "Replacing the toner cartridge" on page 85.)</li><li>• A paper jam has occurred. (See "Clearing paper jams" on page 91.)</li><li>• The cover is opened. Close the cover.</li><li>• There is no paper in the tray. Load paper in the tray.</li><li>• The machine has stopped due to a major error. Check the display message. (See "Understanding display messages" on page 97.)</li></ul>

 Check the message on the display screen, and follow the instruction on the message or refer to Troubleshooting part. See "Troubleshooting" on page 89. If the problem persists, call for service.

## MENU OVERVIEW

The control panel provides access to various menus to set up the machine or use the machine's functions. These menus can be accessed by pressing **Machine Setup**, **Job Status**, or touching menus on the display screen. Refer to the following diagram.

### Main screen

The **Main** screen is shown on the display screen on the control panel. Some menus are grayed out depending on your model.

Copy	Fax	Scan	Document Box	USB
<b>Basic tab (Page 41)</b> Original Size Reduce/Enlarge Duplex Output Original Type Darkness Paper Supply <b>Advanced tab (Page 41)</b> ID Copy N-Up Poster Copy Clone Copy Book Copy Booklet Covers Transparencies WaterMark Overlay Auto Crop <b>Image tab (Page 42)</b> Erase Edge Erase Background Margin Shift	<b>Basic tab (Page 60)</b> Address Duplex Resolution <b>Advanced tab (Page 61)</b> Original Size Delay Send Priority Send Polling Mailbox <b>Image tab (Page 61)</b> Original Type Darkness Erase Background Color Mode	<b>Scan to Email</b> Basic tab (Page 50) Advanced tab (Page 50) Image tab (Page 50) Output tab (Page 51) <b>Scan to PC</b> <b>Scan to Server</b> Basic tab (Page 50) Advanced tab (Page 50) Image tab (Page 50) Output tab (Page 51)	<b>Public tab (Page 84)</b> Detail Edit Delete Delete All Print <b>Secured tab (Page 84)</b> Detail Edit Delete Delete All Print	<b>USB Format</b> <b>USB Print</b> <b>Scan to USB</b> Basic tab Advanced tab Image tab Output tab

### Machine Setup button

When you press the **Machine Setup** button on the control panel, the screen displays three menus. **Machine Status** shows the supplies life, billing, counters and reports. **Admin Setting** lets you set the advanced setup to use your machine in depth and conveniently. **Usage Page Report** can print the report on the amount of printouts depending on the paper size and type.

#### Machine Status

Supplies Life tab
(Page 75) <b>Toner Cartridge</b> <b>Imaging Unit</b> <b>Fuser Kit</b> <b>Feed Roller Kit</b> <b>Feed Roller Kit - Bypass Tray</b> <b>Document Feeder Roller</b> <b>BTR Kit</b> <b>DADF Friction Pad Kit</b>

Machine Info tab
(Page 75) <b>Machine Details</b> <b>Customer Support</b> <b>Machine Serial</b> <b>Number</b> <b>IP Address</b> <b>Hardware Options</b> <b>Configuration</b> <b>Software Versions</b> <b>Tray Status</b> <b>Tray</b> <b>Status</b> <b>Paper Size</b> <b>Paper Type</b> <b>Print/Report</b> <b>System Report</b> <b>Scan Report</b> <b>Fax Report</b>

Machine Info tab (Continued)
<b>Usage Counters</b> <b>Total Impressions</b> <b>Black Impressions</b> <b>Black Copied Impressions</b> <b>Black Printed Impressions</b> <b>Sheets</b> <b>Copied Sheets</b> <b>Black Copied Sheets</b> <b>Printed Sheets</b> <b>Black Printed Sheets</b> <b>2 Sided Sheets</b> <b>Copied 2 Sided Sheets</b>

Machine Info tab (Continued)
<b>Black Copied 2-Sided Sheets</b> <b>Printed 2 Sided Sheets</b> <b>Black Printed 2-Sided Sheets</b> <b>Analog Fax Sheets</b> <b>Analog Fax 2-Sided Sheets</b> <b>Fax Image Received</b> <b>Analog Fax Images Sent</b> <b>Analog Fax Images Received</b> <b>Images Sent</b> <b>Network Scanning Images Sent</b>

Machine Info tab (Continued)
<b>Email Images Sent</b> <b>Maintenance Impressions</b> <b>Black Maintenance Impressions</b>

## Admin Setting

General tab
(Page 76) <b>Device Info</b> <b>Date &amp; Time</b> <b>Default Settings</b> <b>Measurement</b> <b>Timers</b> <b>Language</b> <b>Power Saver</b> <b>Tray Management</b> <b>Altitude Adjustment</b> <b>Output Option</b> <b>Contention Management</b> <b>Sound</b> <b>Supplies Management</b> <b>Machine Test</b> <b>On Demand Overwrite</b> <b>HDD Spooling</b> <b>Stored Job File Policy</b> <b>Country</b>

Setup tab
(Page 78) <b>Copy Setup</b> <b>Fax Setup</b> <b>Network Setup</b> <b>Authentication</b> <b>Optional Service</b> <b>Document Box Management</b>

Print/Report tab
(Page 82) <b>Print</b> <b>Accounting Reports Report</b>

## Usage Page Report

When the display “Are you sure you want to print it?” shows, press “Yes”.

## Job Status button

This menu shows the job in process, in waiting, in completed and the notice message such as an error. (See "Job Status button" on page 20.)

Current Job tab
<b>Detail</b> <b>Delete</b> <b>Delete All</b>

Completed Job tab
<b>Detail</b>

Active Notice tab
<b>Detail</b>



## SUPPLIED SOFTWARE

After you have set up your machine and connected it to your computer, you must install the printer software. If you are a Windows or Macintosh OS, install the software from the supplied CD and if you are a Linux OS user, download the software from the Samsung website ([www.samsung.com/printer](http://www.samsung.com/printer)) and install.

OS	CONTENTS
Windows	<ul style="list-style-type: none"> <li>• <b>Printer driver:</b> Use this driver to take full advantage of your printer's features.</li> <li>• <b>Postscript Printer Definition (PPD) file:</b> Use the PostScript driver to print documents with complex fonts and graphics in the PS language.</li> <li>• <b>Scanner driver:</b> TWAIN and Windows Image Acquisition (WIA) drivers are available for scanning documents on your machine.</li> <li>• <b>Smart Panel:</b> This program allows you to monitor the machine's status and alerts you when an error occurs during printing.</li> <li>• <b>SmarThru Office<sup>a</sup>:</b> This is the accompanying Windows-based software for your multifunctional machine.</li> <li>• <b>Scan and Fax Manager2:</b> This program allows you to scan a document on your machine and save it to a network-connected computer.</li> <li>• <b>Direct Printing Utility:</b> This program allows you to print PDF files directly.</li> <li>• <b>SetIP:</b> Use this program to set your machine's TCP/IP addresses. <b>IPv6</b> is not supported by this program.</li> </ul>
Linux	<ul style="list-style-type: none"> <li>• <b>Postscript Printer Description (PPD) file:</b> Use this file to run your machine from a Linux computer and print documents.</li> <li>• <b>SANE:</b> Use this driver to scan documents.</li> <li>• <b>Smart Panel:</b> This program allows you to monitor the machine's status and alerts you when an error occurs during printing.</li> </ul>
Macintosh	<ul style="list-style-type: none"> <li>• <b>Postscript Printer Driver:</b> Use the PostScript driver to print documents with complex fonts and graphics in the PS language.</li> <li>• <b>Scanner driver:</b> TWAIN driver is available for scanning documents on your machine.</li> <li>• <b>Smart Panel:</b> This program allows you to monitor the machine's status and alerts you when an error occurs during printing.</li> </ul>

a. Allows you to edit a scanned image in many ways using a powerful image editor and to send the image by email. You can also open another image editor program, like Adobe Photoshop, from SmarThru. For details, please refer to the onscreen help supplied on the SmarThru program.

## PRINTER DRIVER FEATURES

Your printer drivers support the following standard features:

- Paper orientation, size, source and media type selection
- Number of copies

In addition, you can use various special printing features. The following table shows a general overview of features supported by your printer drivers:

### Printer driver

FEATURE	PCL 6	POSTSCRIPT		
	WINDOWS	WINDOWS	LINUX	MACINTOSH
<b>Toner save</b>	O	O	O	O
<b>Machine quality option</b>	O	O	O	O
<b>Poster printing</b>	O	X	X	X
<b>Multiple pages per sheet (N-up)</b>	O	O	O (2, 4)	O (2, 4, 6, 9, 16)
<b>Fit to page printing</b>	O	O	O	O
<b>Scale printing</b>	O	O	O	O
<b>Different source for first page</b>	O	X	X	O
<b>Watermark</b>	O	X	X	X
<b>Overlay</b>	O	X	X	X
<b>Duplex<sup>a</sup></b>	O	O	O	O
<b>Secu Print</b>	O	O	X	O
<b>Scheduled Print</b>	O	O	X	O
<b>Spool Print</b>	O	O	X	O
<b>Proof Print</b>	O	O	X	X
<b>Stapler</b>	O	O	O	O

a. The machine with Duplex feature prints both side of a paper.

# getting started

This chapter gives you step-by-step instructions for setting up the machine.

## This chapter includes:

- Setting up the hardware
- Setting up the network
- System requirements

## SETTING UP THE HARDWARE

This section shows the steps to set up the hardware which is explained in the Quick Install Guide. Make sure you read Quick Install Guide and complete following steps.

### 1. Select a stable location.

Select a level, stable place with adequate space for air circulation. Allow extra space to open covers and trays.

The area should be well-ventilated and away from direct sunlight or sources of heat, cold, and humidity. Do not set the machine close to the edge of your desk or table.

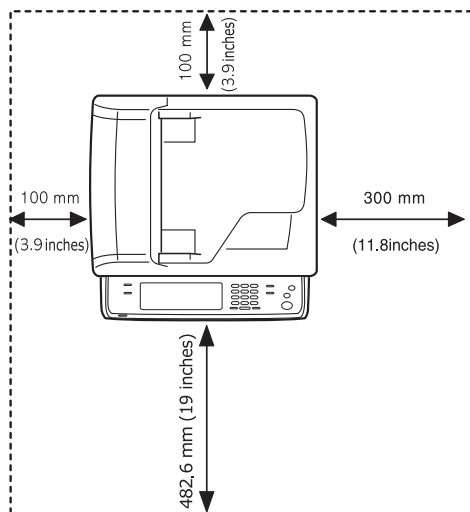

Printing is suitable for altitudes under 1,000 m (3,281 ft). Refer to the altitude setting to optimize your printing. See page 29 for more information.

Place the machine on a flat, stable surface so that there is no incline greater than 5 mm (0.02 inch). Otherwise, printing quality may be affected.

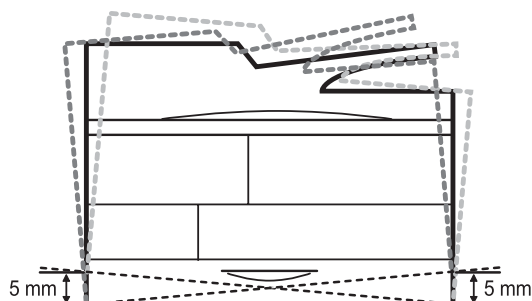

2. Unpack the machine and check all the enclosed items.
3. Remove the tape holding the machine tightly.

- Installing the software
- Machine's basic settings
- Understanding the keyboard

4. Install both the print cartridge and imaging unit.
5. Load paper. (See "Loading paper" on page 38.)
6. Make sure that all the cables are connected to the machine.
7. Turn the machine on.



- When you move the machine, do not tilt or turn it upside down. Otherwise, the inside of the machine may be contaminated by toner, which can cause damage to the machine or bad printing quality.
- If you are moving the machine or if machine is not in use for a long time, turn on the power and wait until it goes in to the ready mode. Then close the scan lid and turn the power off. And open the scan lid and lock the scanner lock.
- This equipment will be inoperable when mains power fails.

## SETTING UP THE NETWORK

You need to set up the network protocols on the machine to use it as your network printer. You can set up the basic network settings with the machine's touch screen.



If you want to use the USB cable, connect the cable between a computer and you machine. Then, refer to *Software section*.

## Supported operating systems

The following table shows the network environments supported by the machine:

ITEM	REQUIREMENTS
<b>Network interface</b>	Ethernet 10/100/1000 Base-TX
<b>Network operating system</b>	<ul style="list-style-type: none"><li>• Novell NetWare 5.x, 6.x (TCP/IP Only)</li><li>• Windows 2000/XP/2003/2008/7/Server 2008 R2</li><li>• Various Linux OS</li><li>• Mac OS 10.3 ~ 10.6</li></ul>
<b>Network protocols</b>	TCP/IP
<b>Dynamic addressing server</b>	DHCP, BOOTP



If you are in a non-static IP address environment and need to set up a DHCP network protocol, go to <http://developer.apple.com/networking/bonjour/download/>, select the Bonjour program that is appropriate for your computer operating system and install the program. This program will allow you to set network parameters automatically. Follow the instructions in the installation window. This program does not support Linux.

## Configuring network protocol via the machine

You can set up TCP/IP network parameters, follow the steps listed below.

1. Make sure your machine is connected to the network with an RJ-45 Ethernet cable.
2. Make sure you have turned on the machine.
3. Press **Machine Setup** on the control panel.
4. Press **Admin Setting**.
5. When the login message appears, enter password. Touch the password input area, then the question marks appears. Use the number keypad on the control panel to enter the password. Once the password is entered, press **OK**. (Factory setting:1111)
6. Press the **Setup** tab > **Network Setup**.
7. Select **TCP/IP Protocol**.
  - **Ethernet Speed:** You can select the communication speed for Ethernet connections.
8. Press **IP Setting**.
9. Select **Static** and then enter **IP Address**, **Subnet Mask** and **Gateway** address fields. Touch the input area then, enter addresses by number keypad on the control panel.

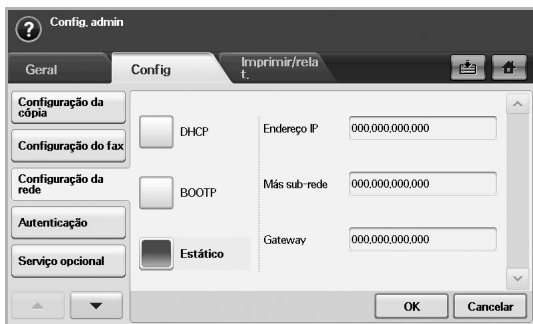

 Contact the network administrator if you are not sure how to configure.

10. Press **OK**.

-  You can also set up the network settings through the network administration programs.
- **SyncThru™ Web Admin Service:** Web-based printer management solution for network administrators. **SyncThru™ Web Admin Service** provides you with an efficient way of managing network devices and lets you remotely monitor and troubleshoot network machines from any site with corporate internet access. Download this program from <http://solution.samsungprinter.com>.
  - **SyncThru™ Web Service:** This is web server embedded on your network printer. If you login with administrator's ID and password on the web server, it allows you to:
    - Configure the network parameters necessary for the machine to connect to various network environments.
    - Customize machine settings.
    - Customize email settings and set up address book for scanning to email.
    - Customize server settings and set up address book for scanning to the FTP or SMB servers.
    - Customize printer, copy, and fax settings
  - **SetIP:** Utility program allowing you to select a network interface and manually configure the IP addresses for use with the TCP/IP protocol. See "Using the SetIP program" on page 31.

## SYSTEM REQUIREMENTS

Before you begin, ensure that your system meets the following requirements:

### Windows

OS	REQUIREMENT (RECOMMENDED)		
	CPU	RAM	FREE HDD SPACE
<b>Windows 2000</b>	Pentium II 400 MHz (Pentium III 933 MHz)	64 MB (128 MB)	600 MB
<b>Windows XP</b>	Pentium III 933 MHz (Pentium IV 1 GHz)	128 MB (256 MB)	1.5 GB
<b>Windows Server 2003</b>	Pentium III 933 MHz (Pentium IV 1 GHz)	128 MB (512 MB)	1.25 GB to 2 GB
<b>Windows</b>	Pentium IV 3 GHz	512 MB (1024 MB)	15 GB
<b>Windows Server 2008</b>	Pentium IV 1 GHz (Pentium IV 2 GHz)	512 MB (2048 MB)	10 GB
<b>Windows 7</b>	Pentium IV 1 GHz 32-bit or 64-bit processor or higher	1 GB (2 GB)	16 GB
			<ul style="list-style-type: none"> <li>• Support for DirectX 9 graphics with 128 MB memory(to enable the Aero theme).</li> <li>• DVD-R/W Drive</li> </ul>
<b>Windows Server 2008 R2</b>	Pentium IV 1 GHz(x86) or 1.4GHz(x64) processors(2GHz or faster)	512 MB (2048 MB)	10 GB

-  • Internet Explorer 5.0 or higher is the minimum requirement for all Windows operating systems.
- Users who have an administrator right can install the software.
  - **Windows Terminal Services** is compatible with this machine.

## Macintosh

OPERATING SYSTEM	REQUIREMENT (RECOMMENDED)		
	CUP	RAM	FREE HDD SPACE
<b>Mac OS X 10.4 or lower</b>	<ul style="list-style-type: none"> <li>PowerPC G4/G5</li> <li>Intel processors</li> </ul>	<ul style="list-style-type: none"> <li>128 MB for a PowerPC based MAC (512 MB)</li> <li>512 MB for an Intel based MAC (1 GB)</li> </ul>	1 GB
<b>Mac OS X 10.5</b>	<ul style="list-style-type: none"> <li>867 MHz or faster PowerPC G4/G5</li> <li>Intel processors</li> </ul>	512 MB (1 GB)	1 GB
<b>Mac OS X 10.6</b>	<ul style="list-style-type: none"> <li>Intel processors</li> </ul>	1 GB (2 GB)	1 GB

## Linux

ITEM	REQUIREMENTS
<b>Operating system</b>	Red Hat 8 ~ 9 Fedora Core 1 ~ 4 Mandrake 9.2 ~ 10.1 SuSE 8.2 ~ 9.2
<b>CPU</b>	Pentium IV 1 GHz or higher
<b>RAM</b>	256 MB or higher
<b>free HDD space</b>	1 GB or higher
<b>Connection</b>	USB interface or Network interface
<b>Software</b>	Linux Kernel 2.4 or higher Glibc 2.2 or higher CUPS SANE

- It is necessary to claim swap partition of 300 MB or larger for working with large scanned images.
- The Linux scanner driver supports the optical resolution at maximum.

## INSTALLING THE SOFTWARE

You have to install the machine software for printing. The software includes drivers, applications, and other user friendly programs.

- The following procedure is for when the machine is being used as a network machine. If you want to connect a machine with a USB cable, refer to *Software section*.
  - The following procedure is based on the Windows XP operating system. The procedure and popup window which appears during the installation may differ depending on the operating system, the printer feature, or the interface in use. (See *Software section*.)
- Make sure that the network setup for your machine is completed. (See "Setting up the network" on page 26.) All applications should be closed on your computer before beginning installation.
  - Insert the Printer Software CD-ROM into your CD-ROM drive. The CD-ROM should automatically run, and an installation window appears. If the installation window does not appear, click **Start > Run**. Type X:\Setup.exe, replacing "X" with the letter which represents your drive and click **OK**. If you use Windows , Windows 7 and Windows Server 2008 R2, click **Start > All Programs > Accessories > Run**, and type X:\Setup.exe. If the **AutoPlay** window appears in Windows , Windows 7 and Windows Server 2008 R2, click **Run Setup.exe** in **Install or run program** field, and click **Continue** in the **User Account Control** window.
  - Click **Next**.

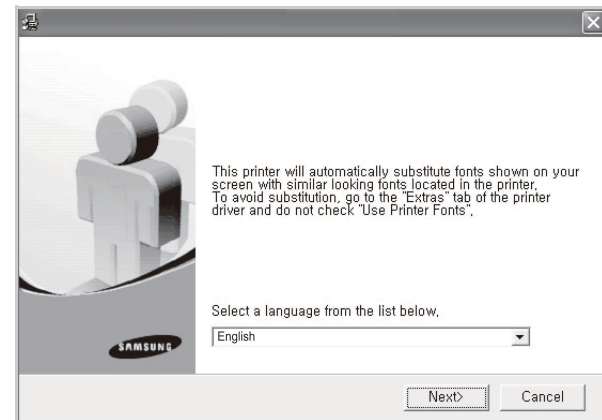

- The window above may slightly differ, if you are reinstalling the driver.
- Select **Typical installation for a network printer**, and then click **Next**.

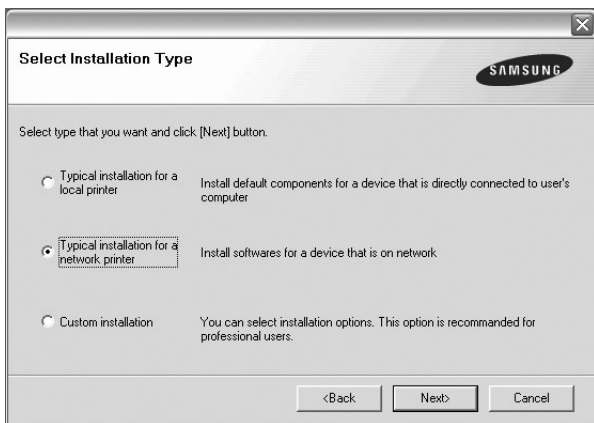

- The list of machines available on the network appears. Select the printer you want to install from the list and then click **Next**.

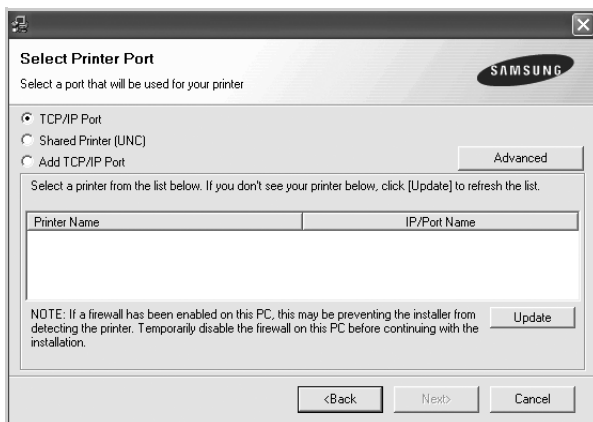

- If you click the **Advanced** button, you can search a printer with the **SNMP Community name**. Default name is 'public'.
- If you do not see your machine on the list, click **Update** to refresh the list, or select **Add TCP/IP Port** to add your machine to the network. To add the machine to the network, enter the port name and the IP address for the machine. To verify your machine's IP address or the MAC address, print a Network Configuration page. (See "Printing a report" on page 82.)
- To find a shared network printer (UNC Path), select **Shared Printer [UNC]** and enter the shared name manually or find a shared printer by clicking the **Browse** button.

 If you are not sure of the IP address, contact your network administrator or print network information. (See "Printing a report" on page 82.)

- After the installation is finished, a window appears asking you to print a test page and to register yourself as a user of Samsung machines in order to receive information from Samsung. If you so desire, select the corresponding checkbox(es) and click **Finish**.

-  If your machine does not work properly after the installation, try to reinstall the printer driver. See *Software section*.
- During the printer driver installation process, the driver installer detects the location information for your operating system and sets the default paper size for your machine. If you use a different Windows location, you must change the paper size to match the paper you usually use. Go to printer properties to change the paper size after installation is complete.

## MACHINE'S BASIC SETTINGS

After installation is complete, you may want to set the machine's default settings. Refer to the next section if you would like to set or change values.

### Altitude adjustment

The print quality is affected by atmospheric pressure, which is determined by the height of the machine above sea level. The following information will guide you on how to set your machine to the best print quality or best quality of print.

Before you set the altitude value, find the altitude where you are using the machine.

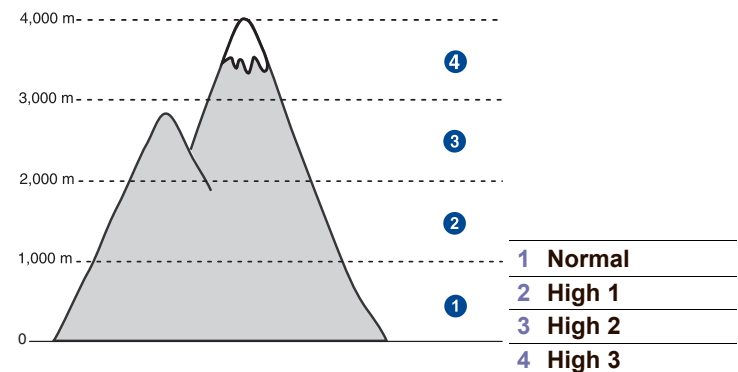

- Enter your machine's IP address as the URL in a browser and click **Go** to access the web site of your machine.
- Click **Machine Settings**.
- Click **Altitude Adj.**
- Select the appropriate altitude value.
- Click **Apply**.



## Setting the authentication password

To set your machine up or change the settings, you have to login. To change password, follow the next steps.

1. Press **Machine Setup** on the control panel.
2. Press **Admin Setting**.
3. When the login message appears, enter password. Touch the password input area, then the question marks appear, use the number keypad on the control panel to enter the password. Then, press **OK**. (Factory setting:1111)
4. Press the **Setup** tab > **Authentication**.
5. Press **Change Admin. Password**.

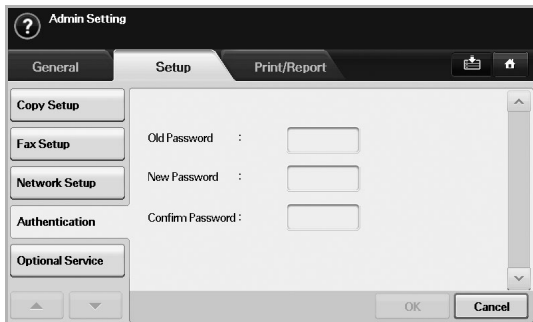

6. Enter old and new password, and then confirm the new password.
7. Press **OK**.

## Setting the date and time

When you set the time and date, they are used in Delay fax and Delay Print, also they are printed on reports. If, however, they are not correct, you need to change it for correct time being.

 If power to the machine is cut off, you need to reset the correct time and date once the power has been restored.

1. Press **Machine Setup** on the control panel.
2. Press **Admin Setting**.
3. When the login message appears, enter password with number keypad and press **OK**. (See "Setting the authentication password" on page 30.)
4. Press the **General** tab > **Date & Time** > **Date & Time**.
5. Select date and time using left/right arrows. Or touch the insert area and use the numeric keypad on the control panel.
6. Press **OK**.

 To change the format of date and time, press **Date Format** and **Time Format**.

## Changing the display language

To change the language that appears on the display, refer to the following steps.

1. Press **Machine Setup** on the control panel.
2. Press **Admin Setting**.
3. When the login message appears, enter password with number keypad and press **OK**. (See "Setting the authentication password" on page 30.)
4. Press the **General** tab.
5. Press the down arrow to switch the screen and press **Language**.
6. Select the desired language.
7. Press **OK**.

## Setting job timeout

When there is no input for a certain period of time, the machine exits the current location. You can set the amount of time the machine will wait.

1. Press **Machine Setup** on the control panel.
2. Press **Admin Setting**.
3. When the login message appears, enter password with number keypad and press **OK**. (See "Setting the authentication password" on page 30.)
4. Press the **General** tab.
5. Press **Timers**.
6. Select **System Timeout**.
  - You can set the **Held Job Timeout** option to over one hour.
7. Select **On**.
8. Select a duration using left/right arrows.
9. Press **OK**.

## Using energy saving feature

The machine provides energy saving features.

1. Press **Machine Setup** on the control panel.
2. Press **Admin Setting**.
3. When the login message appears, enter password with number keypad and press **OK**. (See "Setting the authentication password" on page 30.)
4. Press the **General** tab.
5. Press down arrow to switch the screen, press **Power Saver**.
6. Select appropriate option and time.

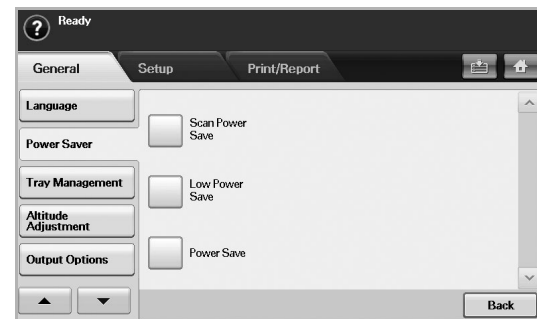

- **Scan Power Save**: Turns off the scanner lamp under the glass.
- **Low Power Save**: Keeps the temperature of the fuser unit under 100 °C, and turns off the fans within the machine except a core fan for the fuser unit.
- **Power Save**: Turns off all the fans even for the fuser unit after certain time.

7. Press **OK**.

## Setting the default tray and paper

You can select the tray and paper you would like to keep using for printing job. (See "General settings" on page 76.)

1. Press **Machine Setup** on the control panel.
2. Press **Admin Setting**.
3. When the login message appears, enter password with number keypad and press **OK**. (See "Setting the authentication password" on page 30.)
4. Press the **General** tab.
5. Press the down arrow to switch the screen and press **Tray Management**.
6. Select tray and its options such as paper size and type.
7. Press **OK**.

 If the optional tray is not installed, the tray options on the screen is grayed out.

## Changing the default settings

You can set the default values for copy, fax, email, scan and paper all at once.

1. Press **Machine Setup** on the control panel.
2. Press **Admin Setting**.
3. When the login message appears, enter password with number keypad and press **OK**. (See "Setting the authentication password" on page 30.)
4. Press the **General** tab > **Default Settings** > **Default Option**.
5. Press the function you want to change, and change its settings.

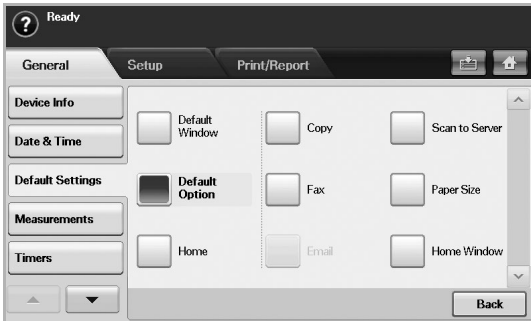

For example, if you want to change the default setting of the brightness & darkness for a copy job, press **Copy** > **Darkness** and adjust the brightness & darkness.

6. Press **OK**.

## Using the SetIP program

This program is for the network IP setting using the MAC address which is the hardware serial number of the network printer card or interface. Especially, it helps the network administrator set several network IPs at the same time.

The following procedure is based on windows XP. If you use Macintosh or Linux OS, see *Software section*

-  You can only use **SetIP** program when your machine is connected to a network.
- The following procedure is based on the Windows XP operating system. If you are using Macintosh or Linux, See *Software section*.
- If you are in a non-static IP address environment and need to setup a DHCP network protocol, go to the <http://developer.apple.com/networking/bonjour/download/>, select the program Bonjour for Windows due to your computer operating system, and install the program. This program will allow you to fix the network parameter automatically. Follow the instruction in the installation window. This Bonjour program does not support Linux
- You can only use **IPv4** setting for **SetIP**.

## Installing the program

1. Insert the driver CD provided along with your machine. When the driver CD runs automatically, close the window.
2. Start **Windows Explorer** and open the X drive. (X represents the name of your CD-ROM drive.)
3. Double-click **Application** > **SetIP**.
4. Open the folder of the language you plan to use.
5. Double-click **Setup.exe** to install this program.
6. Follow the onscreen instructions to complete the installation.

## Setting network values

1. Print the machine's network configuration report to find your machine's MAC address. (See "Printing a report" on page 82.)
2. From the Windows **Start** menu, select **All Programs** > **Samsung Network Printer Utilities** > **SetIP**.
3. Click  to open the TCP/IP configuration window.
4. Enter the network card's MAC address, IP address, subnet mask, default gateway, and then click **Apply**.

 When you enter the MAC address, enter it without a colon(:).

5. Click **OK**, and then the machine prints the network information. Check all the settings are correct.
6. Click **Exit**.



## UNDERSTANDING THE KEYBOARD

You can enter alphabet characters, numbers, or special symbols using the keyboard on the touch screen. This keyboard is specially arranged like a normal keyboard for better usability for the user.

Touch the input area where you need to enter characters and the keyboard pops up on the screen. The keyboard below is the default showing the lowercase letters.



1	<b>Left/Right</b>	Moves the cursor between characters in the input area.
2	<b>Backspace</b>	Deletes the character on the left side of the cursor.
3	<b>Delete</b>	Deletes the character on the right side of the cursor.
4	<b>Clear</b>	Deletes all characters in the input area.
5	<b>Input area</b>	Enters letters within this line.
6	<b>Shift</b>	Toggles between lowercase keys and uppercase keys or vice versa.
7	<b>Symbols</b>	Switches from the alphanumeric keyboard to the symbol keyboard.
8	<b>Space</b>	Enters a blank between characters.
9	<b>OK</b>	Saves and closes input result.
10	<b>Cancel</b>	Cancel and closes input result.

-  If you enter the email address, then the keyboard for email pops up. After you enter the address, press **OK** to activate entered address. Press the arrow key on the side for rotating between **From**, **To**, **Cc**, **Bcc**, **Subject**, **Message** in order.

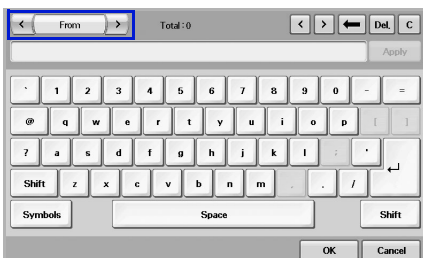

# loading originals and print media

This chapter introduces you to how to load originals and print media into your machine.

## This chapter includes:

- Loading originals
- Selecting print media

## LOADING ORIGINALS

You can use the scanner glass or DADF to load an original for copying, scanning, and sending a fax.

### On the scanner glass

Make sure that no originals are in the DADF. If an original is detected in the DADF, the machine gives it priority over the original on the scanner glass. To get the best scan quality, especially for colored or gray-scaled images, use the scanner glass.

1. Lift and open the scanner lid.

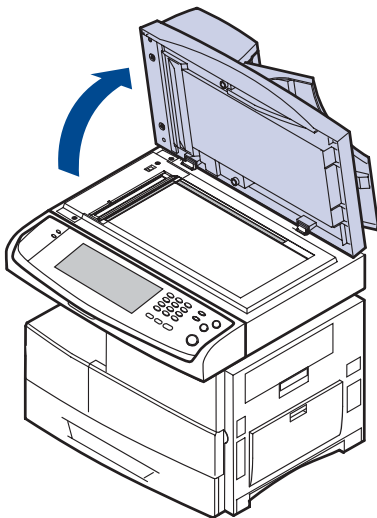

2. Place the original face down on the scanner glass and align it with the registration guide at the top left corner of the glass.

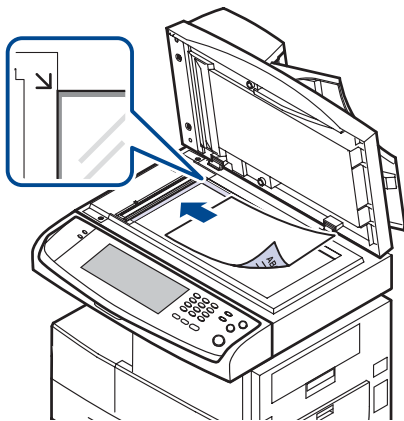

- Loading paper
- Setting the paper size and type

3. Close the scanner lid.



- Leaving the scanner lid open while copying may affect copy quality and toner consumption.
- Dust on the scanner glass may cause black spots on the printout. Always keep it clean. (See "Cleaning the scan unit" on page 84.)
- If you are copying a page from a book or magazine, lift the scanner lid until its hinges are caught by the stopper and then close the lid. If the book or magazine is thicker than 30 mm, start copying with the lid open.

### In the DADF

Using the DADF, you can load up to 100 sheets of paper (75 g/m<sup>2</sup>, 20 lb) for one job.

When you use the DADF:

- Do not load paper smaller than 174 x 128 mm (5.6 x 5.8 inches) or larger than 218 x 356 mm (8.5 x 14 inches).
- Do not attempt to load the following types of paper:
  - carbon-paper or carbon-backed paper
  - coated paper
  - onion skin or thin paper
  - wrinkled or creased paper
  - curled or rolled paper
  - torn paper
- Remove all staples and paper clips before loading.
- Make sure any glue, ink, or correction fluid on the paper is completely dry before loading.
- Do not load originals that include different sizes or weights of paper.
- Do not load booklets, pamphlets, transparencies, or documents having other unusual characteristics.

To load an original into the DADF:

1. Load the original face up into the DADF. Make sure that the bottom of the original stack matches the paper size marked on the document input tray.

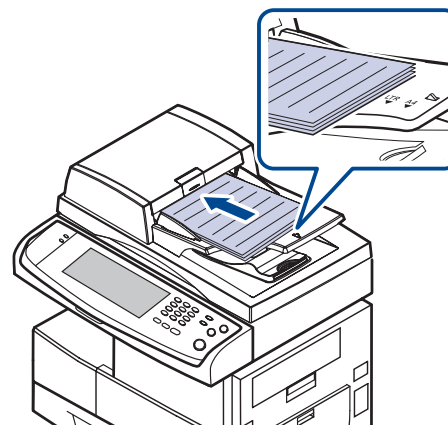

2. Adjust the document width guides to the paper size.

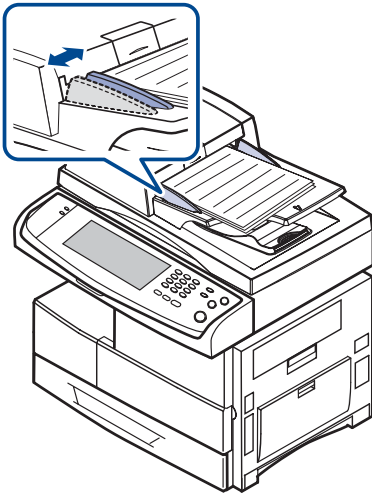

-  Dust on the DADF glass may cause black lines on the printout. Always keep it clean.

## SELECTING PRINT MEDIA

You can print on a variety of print media, such as plain paper, envelopes, labels, and transparencies. Always use print media that meet the guidelines for use with your machine. Print media that does not meet the guidelines outlined in this user's guide may cause the following problems:

- Poor print quality
- Increased paper jams
- Premature wear on the machine.

Properties, such as weight, composition, grain, and moisture content, are important factors that affect the machine's performance and the output quality. When you choose print materials, consider the following:

- The type, size and weight of the print media for your machine are described later in this section.
  - Desired outcome: The print media you choose should be appropriate for your project.
  - Brightness: Some print media are whiter than others and produce sharper, more vibrant images.
  - Surface smoothness: The smoothness of the print media affects how crisp the printing looks on the paper.
-  • Some print media may meet all of the guidelines in this section and still not produce satisfactory results. This may be the result of improper handling, unacceptable temperature and humidity levels, or other variables over which Samsung has no control.
- Before purchasing large quantities of print media, ensure that it meets the requirements specified in this user's guide.

-  Using print media that does not meet these specifications may cause problems, requiring repairs. Such repairs are not covered by Samsung's warranty or service agreements.

## Specification on print media

TYPE	SIZE	DIMENSIONS	WEIGHT <sup>A</sup>	CAPACITY <sup>B</sup>
Plain paper	Letter	216 x 279 mm (8.5 x 11 inches)	<ul style="list-style-type: none"> <li>60 to 90 g/m<sup>2</sup> (16 to 24 lb bond) for the tray</li> <li>60 to 220 g/m<sup>2</sup> (16 to 58 lb bond) for the multi-purpose tray</li> <li>60 to 120 g/m<sup>2</sup> (16 to 32 lb bond) for the high capacity feeder</li> </ul>	<ul style="list-style-type: none"> <li>520 sheets of 75 g/m<sup>2</sup> (20 lb bond) paper for the tray</li> <li>100 sheets of 75 g/m<sup>2</sup> (20 lb bond) in the multi-purpose tray</li> <li>2,100 sheets of 75 g/m<sup>2</sup> (20 lb bond) in the high capacity feeder<sup>c</sup></li> </ul>
	Legal	216 x 356 mm (8.5 x 14 inches)		
	Folio	216 x 330 mm (8.5 x 13 inches)		
	A4	210 x 297 mm (8.26 x 11.69 inches)		
	Oficio	216 x 343 mm (8.5 x 13.5 inches)		
	JIS B5	182 x 257 mm (7.16 x 10.11 inches)		
	ISO B5	176 x 250 mm (6.93 x 9.84 inches)		
	Executive	184 x 267 mm (7.25 x 10.5 inches)		
	A5	148 x 210 mm (5.82 x 8.26 inches)		
	Statement	140 x 216 mm (5.5 x 8.5 inches)		
	A6	105 x 148 mm (4.13 x 5.82 inches)		
Envelope	Envelope B5	176 x 250 mm (6.92 x 9.84 inches)	75 to 90 g/m <sup>2</sup> (20 to 24 lb bond)	<ul style="list-style-type: none"> <li>50 sheets of 75 g/m<sup>2</sup> (20 lb) paper for the tray</li> <li>10 sheets of 75 g/m<sup>2</sup> (20 lb) in the multi-purpose tray</li> </ul>
	Envelope Monarch	98 x 191 mm (3.87 x 7.5 inches)		
	Envelope No. 10	105 x 241 mm (4.12 x 9.5 inches)		
	Envelope DL	110 x 220 mm (4.33 x 8.66 inches)		
	Envelope C5	162 x 229 mm (6.37 x 9.01 inches)		
	Envelope C6	114 x 162 mm (4.48 x 6.38 inches)		
Transparency	Letter, A4, Oficio	Refer to the Plain paper section	138 to 146 g/m <sup>2</sup> (37 to 39 lb)	<ul style="list-style-type: none"> <li>100 sheets of 75 g/m<sup>2</sup> (20 lb) paper for the tray</li> <li>20 sheets of 75 g/m<sup>2</sup> (20 lb) in the multi-purpose tray</li> </ul>
Labels	Letter, Legal, Folio, A4, JIS B5, ISO B5, Executive, A5, Statement, Oficio, A6	Refer to the Plain paper section	120 to 150 g/m <sup>2</sup> (32 to 40 lb bond)	<ul style="list-style-type: none"> <li>100 sheets of 75 g/m<sup>2</sup> (20 lb) paper for the tray</li> <li>10 sheets of 75 g/m<sup>2</sup> (20 lb) in the multi-purpose tray</li> </ul>
Card stock	Letter, Legal, Folio, A4, JIS B5, ISO B5, Executive, A5, Statement, Oficio, A6, Post Card 4x6	Refer to the Plain paper section	90 to 220 g/m <sup>2</sup> (24 to 58 lb bond)	<ul style="list-style-type: none"> <li>50 sheets of 75 g/m<sup>2</sup> (20 lb) paper for the tray</li> <li>10 sheets of 75 g/m<sup>2</sup> (20 lb) in the multi-purpose tray</li> </ul>
<b>Minimum size (custom)</b>		98 x 148 mm (3.86 x 5.83 inches)	60 to 220 g/m <sup>2</sup> (16 to 58 lb bond)	
<b>Maximum size (custom)</b>		216 x 356 mm (8.5 x 14 inches)		

a. If media weight is over 105 g/m<sup>2</sup> (28 lb bond), use the multi-purpose tray.

b. Maximum capacity may differ depending on media weight, thickness, and environmental conditions.

c. High capacity feeder is not supported A6.

## Media sizes supported in each mode

MODE	SIZE	SOURCE
<b>Copy mode</b>	Letter, A4, Legal, Oficio, Folio, Executive, JIS B5, A5, A6	<ul style="list-style-type: none"> <li>tray 1</li> <li>optional tray 2</li> <li>multi-purpose tray</li> <li>high capacity feeder</li> </ul>
<b>Single side printing</b>	All sizes supported by the machine	<ul style="list-style-type: none"> <li>tray 1</li> <li>optional tray</li> <li>multi-purpose tray</li> <li>high capacity feeder</li> </ul>
<b>Duplex printing<sup>a</sup></b>	Letter, A4, Legal, Folio, Oficio, JIS B5, ISO B5, Executive, A5, Statement	<ul style="list-style-type: none"> <li>tray 1</li> <li>optional tray</li> <li>multi-purpose tray</li> <li>high capacity feeder</li> </ul>
<b>Fax mode<sup>b</sup></b>	Letter, A4, Legal	<ul style="list-style-type: none"> <li>tray 1</li> <li>optional tray</li> <li>high capacity feeder</li> </ul>

a. 75 to 90 g/m<sup>2</sup> (20 ~ 24 lb) only

b. Only the optional fax kit is installed.

## Guidelines for special print media

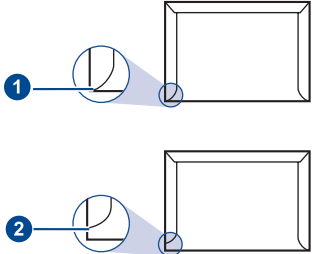
MEDIA TYPE	GUIDELINES
<b>Envelopes</b>	<ul style="list-style-type: none"> <li>Successful printing on envelopes depends upon the quality of the envelopes. When selecting envelopes, consider the following factors: <ul style="list-style-type: none"> <li>- Weight: The weight of the envelope paper should not exceed 90 g/m<sup>2</sup> or jamming may occur.</li> <li>- Construction: Prior to printing, envelopes should lie flat with less than 6 mm curl, and should not contain air.</li> <li>- Condition: Envelopes should not be wrinkled, nicked, or otherwise damaged.</li> <li>- Temperature: You should use envelopes that are compatible with the heat and pressure of the machine during operation.</li> </ul> </li> <li>Use only well-constructed envelopes with sharp and well creased folds.</li> <li>Do not use stamped envelopes.</li> <li>Do not use envelopes with clasps, snaps, windows, coated lining, self-adhesive seals, or other synthetic materials.</li> <li>Do not use damaged or poorly made envelopes.</li> <li>Be sure the seam at both ends of the envelope extends all the way to the corner of the envelope.</li> </ul> <div style="text-align: center;">  </div> <ul style="list-style-type: none"> <li>Envelopes with a peel-off adhesive strip or with more than one flap that folds over to seal must use adhesives compatible with the machine's fusing temperature for 0.1 second. Check your machine's specification to view the fusing temperature, see page see "General specifications" on page 115. The extra flaps and strips might cause wrinkling, creasing, or jams, and may even damage the fuser.</li> <li>For the best print quality, position margins no closer than 15 mm from the edges of the envelope.</li> <li>Avoid printing over the area where the envelope's seams meet.</li> </ul>

MEDIA TYPE	GUIDELINES
<b>Transparencies</b>	<ul style="list-style-type: none"> <li>To avoid damaging the machine, use only transparencies designed for use in laser printers.</li> <li>Transparencies used in the machine must be able to withstand 180 °C, the machine's fusing temperature.</li> <li>Place them on a flat surface after removing them from the machine.</li> <li>Do not leave them in the paper tray for long periods of time. Dust and dirt may accumulate on them, resulting in spotty printing.</li> <li>To avoid smudging caused by fingerprints, handle them carefully.</li> <li>To avoid fading, do not expose printed transparencies to prolonged sunlight.</li> <li>Ensure that transparencies are not wrinkled, curled, or have any torn edges.</li> </ul>
<b>Labels</b>	<ul style="list-style-type: none"> <li>To avoid damaging the machine, use only labels designed for use in laser machines. <ul style="list-style-type: none"> <li>When selecting labels, consider the following factors: <ul style="list-style-type: none"> <li>Adhesives: The adhesive material should be stable at your machine's fusing temperature. Check your machine's specification to view the fusing temperature, see page 115.</li> <li>Arrangement: Only use labels with no exposed backing between them. Labels can peel off sheets that have spaces between the labels, causing serious jams.</li> <li>Curl: Prior to printing, labels must lie flat with no more than 13 mm of curl in any direction.</li> <li>Condition: Do not use labels with wrinkles, bubbles, or other indications of separation.</li> </ul> </li> </ul> </li> <li>Make sure that there is no exposed adhesive material between labels. Exposed areas can cause labels to peel off during printing, which can cause paper jams. Exposed adhesive can also cause damage to machine components.</li> <li>Do not run a sheet of labels through the machine more than once. The adhesive backing is designed for only a single pass through the machine.</li> <li>Do not use labels that are separating from the backing sheet or are wrinkled, bubbled, or otherwise damaged.</li> </ul>
<b>Card stock or custom-sized materials</b>	<ul style="list-style-type: none"> <li>Do not print on media smaller than 98 mm wide or 356 mm long.</li> <li>In the software application, set margins at least 6.4 mm away from the edges of the material.</li> </ul>

MEDIA TYPE	GUIDELINES
<b>Preprinted paper</b>	<ul style="list-style-type: none"> <li>Letterhead must be printed with heat-resistant ink that will not melt, vaporize, or release hazardous emissions when subjected to the printer's fusing temperature for 0.1 second. Check your machine's specification to view the fusing temperature, see page 115.</li> <li>Letterhead ink must be non-flammable and should not adversely affect printer rollers.</li> <li>Forms and letterhead should be sealed in a moisture-proof wrapping to prevent changes during storage.</li> <li>Before you load preprinted paper, such as forms and letterhead, verify that the ink on the paper is dry. During the fusing process, wet ink can come off preprinted paper, reducing print quality.</li> </ul>

## CHANGING THE SIZE OF THE PAPER IN THE PAPER TRAY

To load longer sizes of paper, such as Legal-sized paper, you need to adjust the paper guides to extend the paper tray.

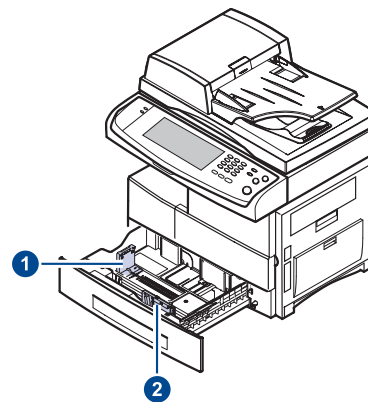

- 1 paper length guide**
- 2 paper width guide**

 If you have installed an optional high capacity feeder, refer to Quick Install Sheet to adjust paper size.

- Adjust the paper length guide to the desired paper length. It is preset to Letter or A4 size depending on the country. To load another size, hold the lever and move the length guide to the corresponding position.

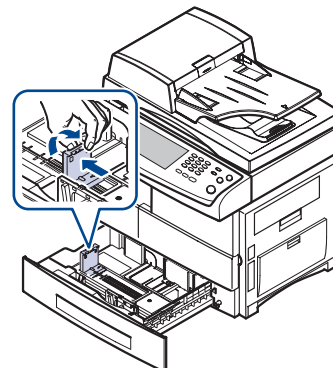



- After inserting paper into the tray, while pinching the paper width guide as shown, move it toward the stack of paper until it lightly touches the side of the stack. Do not press the guide too tightly to the edge of the paper; the guide may bend the paper.

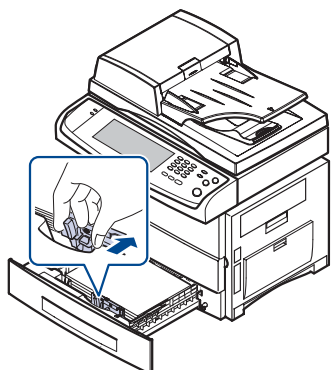

When you use legal-sized paper, you need to extend the length of the tray.

- Load the paper into the tray.
- Place the tray into the machine.
- Set the paper size from your computer.

- Do not push the paper width guides far enough to cause the materials to warp.
- If you do not adjust the paper width guides, it may cause paper jams.

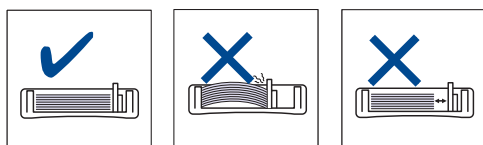

## LOADING PAPER

### Loading paper in tray 1, optional tray or optional high capacity feeder

Load the print media you use for the majority of your print jobs in the tray 1. The tray 1 can hold a maximum of 520 sheets of 75 g/m<sup>2</sup> (20 lb bond) plain paper.

You can purchase an optional tray and attach it below the standard tray to load an additional 520 sheets of paper. (See "Supplies" on page 110.)

- Using photographic paper or coated paper may cause problems, requiring repairs. Such repairs are not covered by Samsung's warranty or service agreement.

- To load paper, pull and open the paper tray and place paper with the side you want to print facing down.

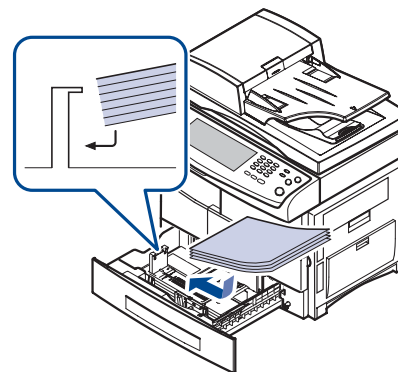

- 
- Full
  - Empty
- 

- Place the side to be printed facing up.

ENVELOPE	PREPRINTED PAPER	TRANSPARENCY
PUNCHED PAPER	CARD STOCK	LETTERHEAD PAPER
LABEL		

- After loading paper, set the paper type and size for the tray 1. See "Setting the paper size and type" on page 40 for copying and faxing or *Software section* for PC-printing.

- If you experience problems with paper feed, place one sheet at a time in the multi-purpose tray.
- You can load previously printed paper. The printed side should be facing up with an uncurled edge at the front. If you experience problems with paper feed, turn the paper around. Note that print quality is not guaranteed.



## In the multi-purpose tray

The multi-purpose tray can hold special sizes and types of print material, such as postcards, note cards, and envelopes. It is useful for single page printing on letterhead or colored paper.

### Tips on using the multi-purpose tray

- Load only one size of print media at a time in the multi-purpose tray.
- To prevent paper jams, do not add paper when there is still paper in the multi-purpose tray. This also applies to other types of print media.
- Print media should be loaded face down with the top edge going into the multi-purpose tray first and be placed in the center of the tray.
- Always load only the specified print media to avoid paper jams and print quality problems. (See "Selecting print media" on page 34.)
- Flatten any curl on postcards, envelopes, and labels before loading into the multi-purpose tray.

To load paper in the multi-purpose tray:

1. Open the multi-purpose tray and unfold the multi-purpose tray extension, as shown.

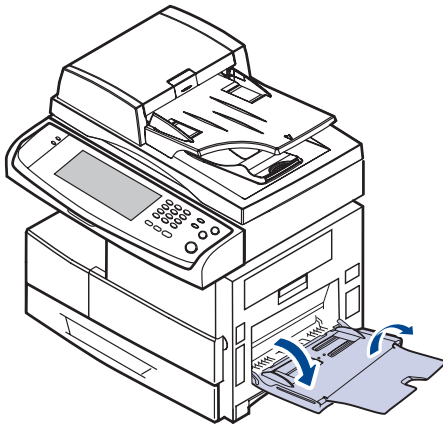

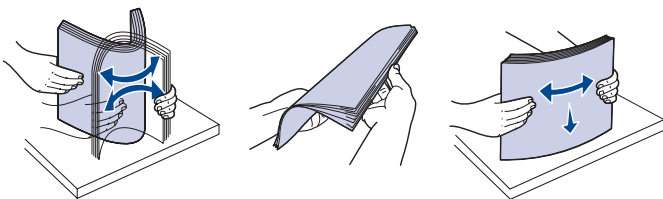

2. If you are using paper, flex or fan the edge of the paper stack to separate the pages before loading.

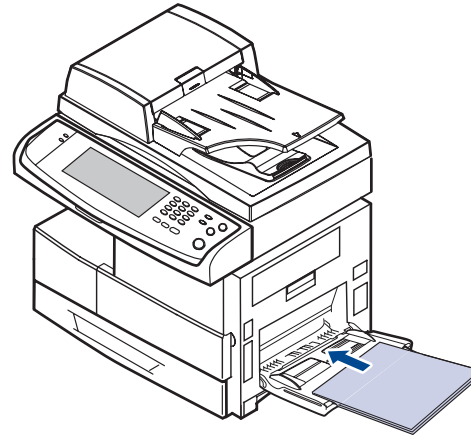

For transparencies, hold them by the edges and avoid touching the print side. Oils from your fingers can cause print quality problems.

3. Load the paper.

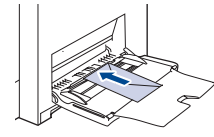
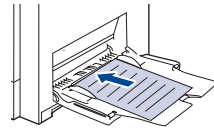
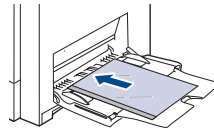
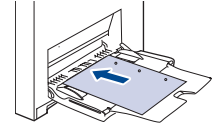
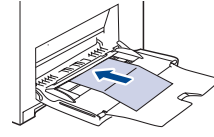
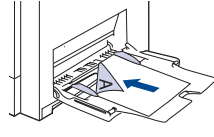
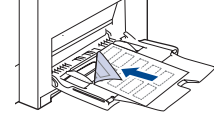

-  Place the side to be printed facing down.

ENVELOPE	PREPRINTED PAPER	TRANSPARENCY
		
PUNCHED PAPER	CARD STOCK	LETTERHEAD PAPER
		
LABEL		
		

4. Squeeze the multi-purpose tray paper width guides and adjust them to the width of the paper. Do not force too much, or the paper will be bent, which will result in a paper jam or skew.

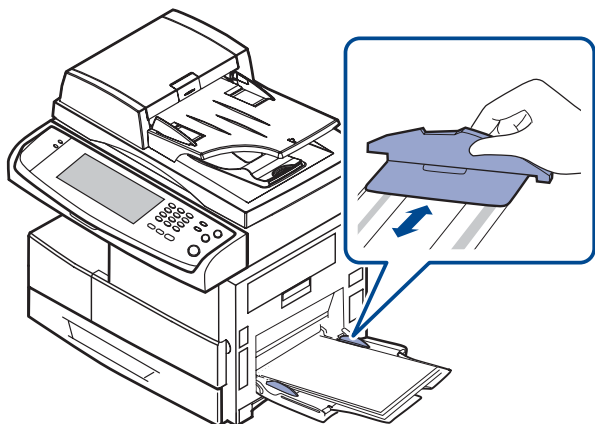

5. Depending on the media type you are using, keep the following loading guidelines:
    - Envelopes: Flap side down and with the stamp area on the top left side.
    - Transparencies: Print side up and the top with the adhesive strip entering the machine first.
    - Labels: Print side up and top short edge entering the machine first.
    - Preprinted paper: Design side up with the top edge toward the machine.
    - Card stock: Print side up and the short edge entering the machine first.
    - Previously printed paper: Previously printed side down with an uncurled edge toward the machine.
  5. After loading paper, set the paper type and size for the multi-purpose tray. See "Setting the paper size and type" on page 40 for copying and faxing or the *Software section* for PC-printing.
6. After printing, fold the multi-purpose tray extension and close the multi-purpose tray.

## SETTING THE PAPER SIZE AND TYPE

After loading paper in the paper tray, you need to set the paper size and type. These settings will apply to **Copy** and **Fax** modes.

For PC-printing, you need to select the paper size and type in the application program you use on your PC.

1. Press **Machine Setup** on the control panel.
2. Press **Admin Setting**.
3. When the login message appears, enter password with number keypad and press **OK**. (See "Setting the authentication password" on page 30.)
4. Press the **General** tab.
5. Press the down arrow to switch the screen, press **Tray Management**.
6. Select tray and its options such as paper size and type.
7. Press **OK**.

# copying

This chapter gives you information about using your machine as a copy machine.

## This chapter includes

- Understanding the Copy screen
- Copying originals

## UNDERSTANDING THE COPY SCREEN

When you press **Copy** on the **Main** screen, the **Copy** screen appears which has several tabs and lots of copying options. All the options are grouped by features so that you can configure your selections easily.

If the screen displays an other menu, press (  ) to go to the **Main** screen.

### Basic tab



- **Original Size:** Selects the size of the originals. (See "Changing the size of originals" on page 42.)
- **Reduce/Enlarge:** Reduces or enlarges the size of a copied image. (See "Reducing or enlarging copies" on page 43.)
- **Duplex:** Sets the machine to print copies on both sides of the paper. (See "Copying on both sides of originals (Duplex)" on page 43.)
- **Output:** Selects **Collated** or **Uncollated** copy options. If you install the optional stacker & stapler, then the staple related option appears. (See "Deciding the form of copy output (Collated / Staple)" on page 44.)
- **Original Type:** Improves the copy quality by selecting the document type for the current copy job. (See "Selecting the type of originals" on page 44.)
- **Light, Dark:** Adjusts the brightness level to make a copy that is easier to read, when the original contains faint markings and dark images. (See "Changing the darkness" on page 44.)
- **Paper Supply:** Selects the paper supply tray.

### Advanced tab

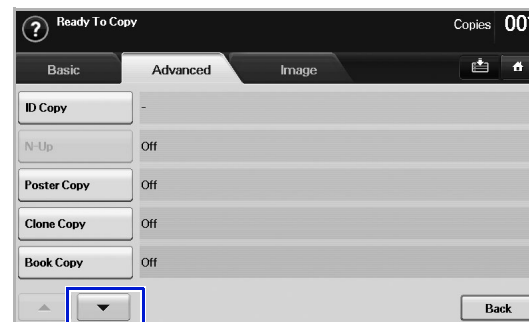

- **ID Copy:** Prints 2-sided originals on one sheet of paper. This feature is helpful for copying a small-sized item, such as a business card. (See "ID card copying" on page 44.)
- **N-Up:** Prints 2 or 4 original images, reduced to fit onto one sheet of paper. (See "Copying ID with the manual ID copy option" on page 45.)
- **Poster Copy:** Prints a large image into divided 9 pages. (See "Poster copying" on page 45.)
- **Clone Copy:** Prints multiple image copies from the original document on a single page. (See "Clone copying" on page 46.)
- **Book Copy:** Allows you to copy an entire book. (See "Book copying" on page 46.)
- **Booklet:** Creates booklets from a sequential set of either 1-sided or 2-sided originals. (See "Booklet copying" on page 46.)
- **Covers:** Automatically adds covers to your copied set using stock taken from a different tray. (See "Cover copying" on page 47.)
- **Transparencies:** Adds a blank or printed divider between transparencies within a set. (See "Transparency copying" on page 47.)
- **WaterMark:** Prints an image with the added watermark. (See "Watermark copying" on page 48.)
- **Overlay:** Prints an image with the image previously stored in your machine. (See "Overlay copying" on page 48.)
- **Auto Crop:** Prints only the image of an original after cropping the blank parts like the margin. (See "Auto crop copying" on page 48.)

## Image tab

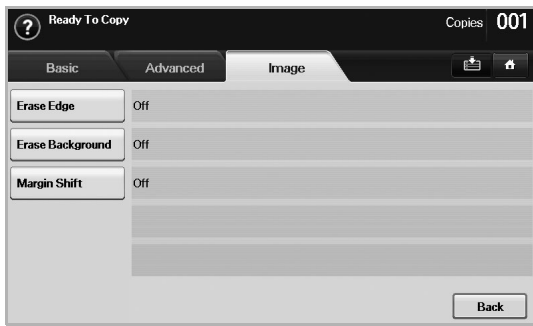

- **Erase Edge:** Allows you to erase punch holes, staple marks, and fold creases along any of the four documents edges. (See "Erasing edges" on page 47.)
- **Erase Background:** Prints an image with no background. (See "Erasing background images" on page 47.)
- **Margin Shift:** Creates a binding edge for the document. (See "Shifting margins" on page 47.)

## COPYING ORIGINALS

This is the normal and usual procedure for copying your originals.

1. Press **Copy** from the **Main** screen.
2. Place originals, face up, in the DADF, or you can use the scanner glass with a single original document face down.

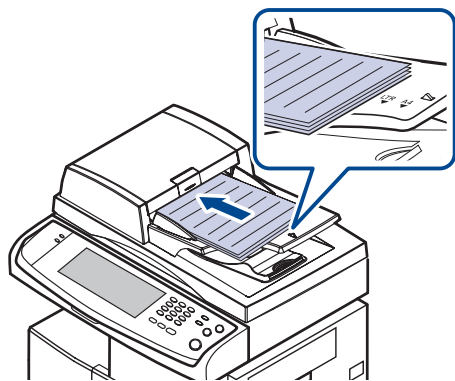

3. Adjust the settings for each copy such as **Original Size**, **Reduce/Enlarge**, **Duplex** and more. (See "Changing the size of originals" on page 42., see "Copying on both sides of originals (Duplex)" on page 43.)



4. Select the tray by pressing the appropriate tray on screen.



5. Enter the number of copies using the number keypad, if necessary.
  - ☑ If you want to copy originals on the scanner glass and copy more than two copies, the message **Another Page?** appears after the first page copied. At this time, if you select **No**, the machine starts copying the rest of your originals and sorts the copied papers in order. Because the default value of the **Output** option is **Collated**.
6. Press **Start** on the control panel to begin copying.
  - ☑ To cancel the current copy job, press **Stop** on the control panel. Or you can delete the current and pending job using **Job Status** on the control panel. Select the job you want to cancel and press **Delete**.

## CHANGING THE SETTINGS FOR EACH COPY

On the **Basic** tab of the **Copy** screen, you can select copy features before starting to copy.

- ☑ The **Basic** tab setting is only for each copy. That means that the setting does not apply to the next copy job. After finishing the current copy job, the machine automatically restores the default settings after certain time. Or the machine resume to default setting when you press the **Clear All** button on the control panel or when you press other menu such as fax or else except the **Job Status** screen. The default copy setting can be changed in **Admin Setting**. (See "General settings" on page 76.)

## Changing the size of originals

Press the **Basic** tab > **Original Size**, then use left/right arrows to set the original size.

Press **more** to see the detail values.

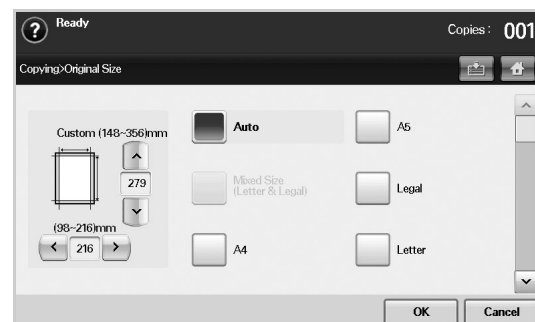

- **Custom:** Selects the scanning area of the original. Press the cardinal point arrows to set the size.
- **Auto:** Automatically detects the size of originals, but this option supports only when originals are Legal, Letter, or A5 sized. If the originals is mixed-sized, then the machine detects the largest original size and select the largest-sized paper in the tray.
- **Mixed Size (Letter & Legal):** Allows for the use of both of Letter and Legal sized papers together, and the machine uses the proper-sized paper from several trays. For example, if the originals are total 3 pages, 1st page is the letter-sized paper, 2nd page is the legal-sized

paper, and 3rd page is the letter-sized paper, then the machine prints the output first letter, legal, and letter in order from several trays.

- Other preset values: Allows user to easily select commonly used values.

## Reducing or enlarging copies

Press the **Basic** tab > **Reduce/Enlarge**, then use left/right arrows to reduce or enlarge an image on the paper.

Press **more** to see the values.

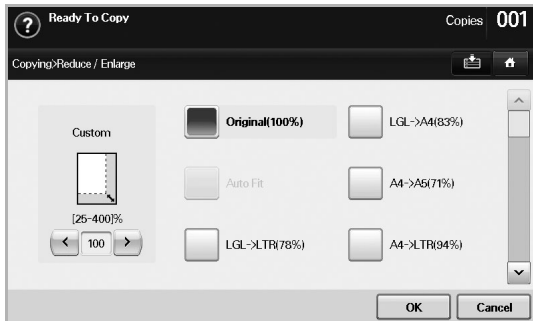

- **Original(100%)**: Prints texts or images the same size as originals.
- **Auto Fit**: Reduces or enlarges the original based on the size of the output paper.
- Other preset values: Allows you to easily select commonly used values.

The **Custom** option is different depending on where the originals is placed. In the DADF, 25~200% adjustment is possible. And in the scanner glass, 25~400% adjustment is possible.

## Copying on both sides of originals (Duplex)

Press the **Basic** tab > **Duplex**, then use left/right arrows to select **Duplex** value.

If you want to copy originals on the scanner glass and copy both sides of originals, the message **Another Page?** appears after the first page copied. At this time, load the original's the other side facing down and press **Yes**, then the machine starts scanning the second page of your original.

Press **more** to see the detail values.

- **1 -> 1 Sided**: Scans one side of an original and prints on one side of the paper, this function produces exactly the same print out from originals.

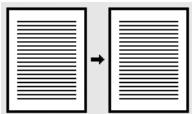

- **1 -> 2 Sided**: Scans one side of originals and prints them on both sides of the paper.

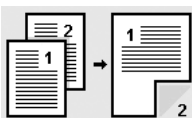

- **1 -> 2 Sided, Rotate Side 2**: Scans one side of the originals and prints on both sides of the paper, but the information on the back side of the print out is rotated 180°.

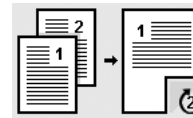

- **2 -> 1 Sided**: Scans both sides of the originals and prints each of one on a separate sheet.

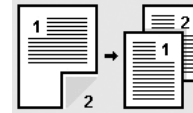

- **2 -> 2 Sided**: Scans both sides of the original and prints on both sides of the paper. This function produces exactly the same print out from the originals.

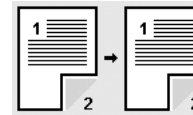

- **2 -> 1 Sided, Rotate Side 2**: Scans both sides of the original and prints each one on a separate sheet, but the information on the back side of the printout is rotated 180°.



- **Reverse 1 -> 2 Sided**: Scans originals and prints them on both sides of a paper. But the machine reverses the print out order of the originals. The machine prints the second original first, which means the firstly input original is printed on the back side of a paper. For instance, if you print 6 sheet of original papers, every even numbered pages of originals will be printed on the front side of a paper, and every odd numbered pages of originals will be printed on the back side of a paper.

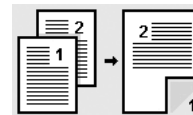

- **Reverse 1 -> 2 Sided, Rotate Side 2**: Scans originals and prints them on both sides of a paper. But the machine reverses the print out order of the originals. The machine prints the second original first, which means the firstly input original is printed on the back side of a paper. For instance, if you print 6 sheet of original papers, every even numbered pages of originals will be printed on the front side of a paper, and every odd numbered pages of originals will be printed on the back side of a paper. The information on the back side of the print out is rotated 180°.

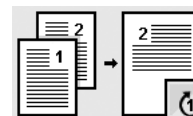

- **Reverse 2 -> 2 Sided**: Scans the both sides of originals and prints them on both sides of a paper. But the machine reverses the print out order of the originals. The machine prints the back sides of originals first, which means the front sides of originals is printed on the back side of a paper.



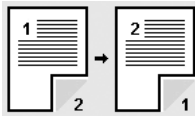

## Deciding the form of copy output (Collated / Staple)

Press the **Basic** tab > **Output**, then use left/right arrows to select **Collated** or **Stapled**. This feature is supported only when the original is on the DADF.

 If you want to copy originals on the scanner glass and copy both sides of originals, the message **Another Page?** appears after the first page copied. At this time, load the original's the other side facing down and press **Yes**, then the machine starts scanning the second page of your original.

Press **more** to see the values.

- **Collated:** Prints output in sets to match the sequence of originals.

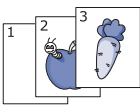

- **Uncollated:** Prints output sorted into stacks of individual pages.

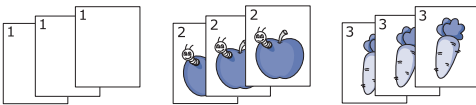

- **Staple, Portrait:** Adds a single staple to all of your portrait-oriented output.



- **Staple, Landscape:** Adds a single staple to all of your landscape-oriented output.

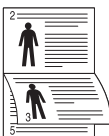

 The Staple feature is available with an optional stacker & stapler. (See "Stacker & Stapler (Finisher)" on page 110.)

## Selecting the type of originals

Press the **Basic** tab and select an appropriate original type.



- **Text:** Use for originals containing mostly text.
- **Text/Photo:** Use for originals with mixed text and photographs.
- **Photo:** Use when originals are photographs.

## Changing the darkness

This defines the degree of darkness. Use left/right arrows to change the level of light/dark in the printouts.



## USING SPECIAL COPY FEATURES

On the **Advanced** tab or the **Image** tab of the **Copy** screen, you can select specific copy features.

### ID card copying

The machine prints one side of the original on the upper half of the paper and the other side on the lower half without reducing the size of the original. This feature is helpful for copying a small-sized item, such as a business card.

This copy feature is available only when you place originals on the scanner glass.

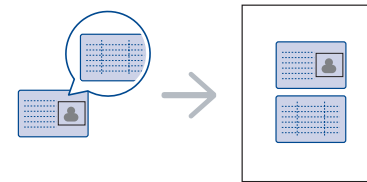

 The original must be placed on the scanner glass to use this feature.

1. Place the front side of an original facing down on the scanner glass where arrows indicate as shown, and close the scanner lid.

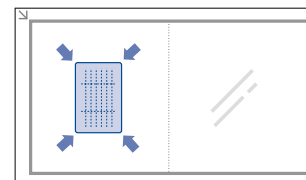

2. Press **Copy** from the **Main** screen.
3. Select the tray in **Paper Supply**.
4. Press the **Advanced** tab > **ID Copy**.
5. Press **Start** on the control panel.  
Then the machine starts scanning the front side.
6. Turn the original over and place it on the scanner glass, where arrows indicate as shown. Then, close the scanner lid.

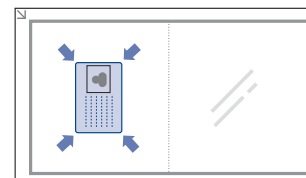

7. Press **Start** on the control panel to begin copying.

- If the original is larger than the printable area, some portions may not be printed.
- If this option is grayed out, select the **Duplex** option to 1 -> 1 **Sided**, the **Output** option to **Collated**.

## Copying ID with the manual ID copy option

If you want to copy several ID cards on a paper, or adjust the copying position of the page, follow the next steps.

Next steps are the procedure when you copy two people's driver's license cards (100mm X 80mm) in one page.

- 1 Press **Machine Setup** on the control panel.
- 2 Select **Admin Setting**. When the login message pops up, then enter password and press **OK**.
- 3 Press the **Setup tab > Copy Setup > Manual ID Copy Setup**.
- 4 Press the number from the template list table.
- 5 Press **Edit Template**.
- 6 Select the appropriate option values and press **OK**.
  - **Template Name**: Enter the template name.
  - **Scan Position**: Select the position for scanning. You should select the largest scanning position out of the originals.

LEFT, TOP : X-000mm/Y-000mm, RIGHT, BOTTOM: X-110mm/Y-090mm

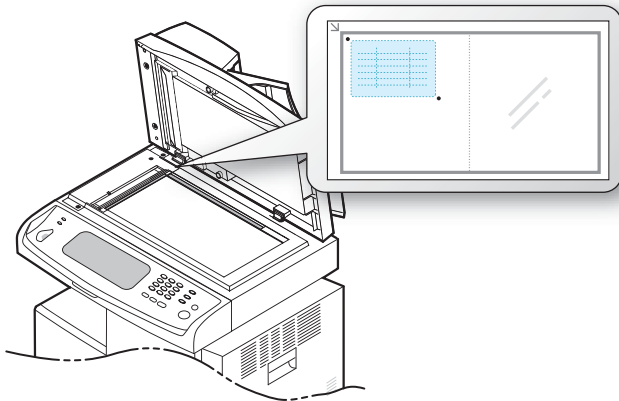

- **Number of Images**: Select how many images are on a page. (select number 4.)
- **Image Position**: Select the position of a page which images are on. If you choose to copy four images, you have to select four positions here.
- **First Image Position**: LEFT, TOP : X-000mm/Y-020mm, RIGHT, BOTTOM: X-100mm/Y-100mm
- **Second Image Position**: LEFT, TOP : X-105mm/Y-020mm, RIGHT, BOTTOM: X-205mm/Y-100mm
- **Third Image Position**: LEFT, TOP : X-000mm/Y-150mm, RIGHT, BOTTOM: X-100mm/Y-230mm

- **Fourth Image Position**: LEFT, TOP : X-105mm/Y-150mm, RIGHT, BOTTOM: X-205mm/Y-230mm

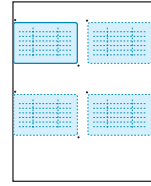

- 7 Press **OK**, the template you have saved will be shown in the template list table.
- 8 Press  and select **Copy**.
- 9 Press the **Advanced tab > ID Copy > Manual ID Copy Setup**.
- 10 Press the template you have saved from the template list.
- 11 Press the **Start** button on the control panel. now follow the instruction on display to finish the ID copy for four images

## 2-up or 4-up copying (N-up)

The machine reduces the size of the original images and prints 2 or 4 pages onto one sheet of paper.

2 or 4-up copying is available only when you load originals into the DADF.



1. Place the originals face up in the DADF. Or place a single original face down on the scanner glass. (See "Loading originals" on page 33.)
2. Press **Copy** from the **Main** screen.
3. Select the tray in **Paper Supply**.
4. Press the **Advanced tab > N-Up**.
5. Select **Off**, **2Up**, or **4Up**.
  - **Off**: Copies an original onto one sheet of paper.
  - **2Up**: Copies two separate originals onto one page.
  - **4Up**: Copies four separate originals onto one page.
6. Press **Start** on the control panel.

- You cannot adjust the copy size using the **Reduce/Enlarge** for the **N-Up** feature.

## Poster copying

Your original will be divided into 9 portions. You can paste the printed pages together to make one poster-sized document. This copy feature is available only when you place originals on the scanner glass. Each portion is scanned and printed on by one in the following order.

This copy feature is available only when you place originals on the scanner glass.



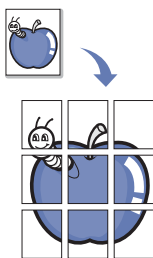

1. Place a single original face down on the scanner glass. (See "Loading originals" on page 33.)
2. Press **Copy** from the **Main** screen.
3. Select the tray in **Paper Supply**.
4. Press the **Advanced** tab > **Poster Copy**.

 This feature is available only when the options in the **Basic** tab are selected as below;

- **Duplex** to **1 -> 1 Sided**
- **Reduce/Enlarge** to **Original(100%)**
- **Paper Supply** to **Tray**.

5. Press **On** to activate this feature.
6. Press **OK**.
7. Press **Start** on the control panel to begin copying.

 Your original is divided into 9 portions. Each portion is scanned and printed one by one in the following order:

1	2	3
4	5	6
7	8	9

## Clone copying

The machine prints multiple original images on a single page. The number of images is automatically determined by the original image and the paper size.

This copy feature is available only when you place originals on the scanner glass.

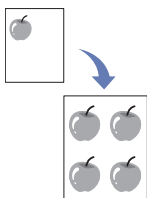

1. Place a single original face down on the scanner glass. (See "Loading originals" on page 33.)
2. Press **Copy** from the **Main** screen.
3. Select the tray in **Paper Supply**.
4. Press the **Advanced** tab > **Clone Copy**.

 This feature is available only when the options in the **Basic** tab are selected as below;

- **Duplex** to **1 -> 1 Sided**
- **Reduce/Enlarge** to **Original(100%)**
- **Paper Supply** to **Tray**.

5. Press **On** to activate this feature.
6. Press **OK**.
7. Press **Start** on the control panel to begin copying.

## Book copying

Use this feature to copy a book. If the book is too thick, lift the scanner lid until its hinges are engaged by the stopper and then close the scanner lid. If the book or magazine is thicker than 30 mm (1.18 inches), start copying with the scanner lid open.

This copy feature is available only when you place originals on the scanner glass.

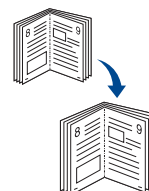

1. Place the originals face down on the scanner glass. (See "Loading originals" on page 33.)
2. Press **Copy** from the **Main** screen.

 To remove shadows of a book edge, press the **Image** tab > **Erase Edge** > **Book Center and Edges Erase**.

3. Press the **Advanced** tab > **Book Copy**.
4. Select the binding option.
  - **Off**: Disables this feature.
  - **Left Page**: Prints left page of the book.
  - **Right Page**: Prints right page of the book.
  - **Both Page**: Prints both facing pages of the book.
5. Press **OK**.
6. Press **Start** on the control panel to begin copying.

## Booklet copying

The machine automatically prints on one or both sides of the paper, which are then folded to produce a booklet with all of the pages in the correct sequence.

The machine will also reduce and correctly adjust the position of each image to fit on the selected paper.

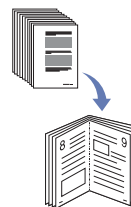

1. Place the originals face up in the DADF. Or place a single original face down on the scanner glass. (See "Loading originals" on page 33.)
2. Press **Copy** from the **Main** screen.
3. Select the tray in **Paper Supply**.
4. Press the **Advanced** tab > **Booklet**.
5. Press **On** to use this feature, and select detailed settings for each option.
  - **1 Sided Original**: Copies on one side of the paper.
  - **2 Sided Original**: Copies on both sides of the paper.

6. Press **OK**.
7. Press **Start** on the control panel to begin copying.

 This feature is possible only with A4, Letter, Legal, Folio, Oficio, JIS B5, ISO B5, Executive, A5 and Statement sized paper.

## Cover copying

The machine automatically adds covers to your copied set using stock taken from a different tray. Covers must be the same size and orientation as the main body of the job.

1. Place the originals face up in the DADF. Or place a single original face down on the scanner glass. (See "Loading originals" on page 33.)
2. Press **Copy** from the **Main** screen.
3. Select the tray in **Paper Supply**.
4. Press the **Advanced** tab > **Covers**.

 Once you have set the **Paper Supply** option to **Auto**, you cannot use this feature.

5. Press **On** to use this feature, and select detailed settings for each option.
  - **Position:** Selects whether the cover will be placed at the front, back, or both.
  - **Cover Sheet:** Selects whether the cover will be 1 sided, 2 sided, or blank paper.
  - **Paper Source:** Select the paper tray, where the cover sheet is loaded.
6. Press **OK**.
7. Press **Start** on the control panel to begin copying.

## Transparency copying

When you prepare transparencies for presentations, use this feature to copy the information.

 Before you start this special copy job, set the tray's Paper Types and Paper Size to Transparency. (See "Setting the paper size and type" on page 40.)

1. Place the originals face up in the DADF. Or place a single original face down on the scanner glass. (See "Loading originals" on page 33.)
2. Load the right-sized transparencies into the tray you have set.
3. Set the paper type to **Transparency**.
4. Press **Copy** from the **Main** screen.
5. Press the **Advanced** tab > **Transparencies**.
6. Select **Transparencies** option.
  - **No Separator:** Does not place separator sheets between transparencies.
  - **Blank Sheet:** Places a blank sheet between transparencies.
  - **Printed Sheet:** Places the same image on the divider sheets as printed on the transparency.
7. Select media sources, in case you selected either **Blank Sheet** or **Printed Sheet**.
8. Press **OK**.
9. Press **Start** on the control panel to begin copying.

## Erasing edges

You can copy the original without any edges or margins.

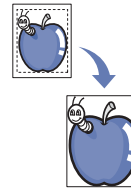

1. Place a single original face down on the scanner glass. Or load the originals face up in the DADF. (See "Loading originals" on page 33.)
  2. Press **Copy** from the **Main** screen.
  3. Press the **Image** tab > **Erase Edge**.
  4. Select the appropriate option.
    - **Off:** Disables this feature.
    - **Border Erase:** Erases equal amounts on all edges of the copies.
    - **Small Original Erase:** Erases 0.25" (6mm) from the edge of the copies. The original must be placed on the scanner glass to use this feature.
    - **Hole Punch Erase:** Erases hole punch marks from the left edge of the copies.
    - **Book Center and Edges Erase:** Erases shadows of a binding or book edge from the center and side edges of the copies. This feature only applies when you do copying a book. (See "Book copying" on page 46.)
-  If you have set the **Book Copy** option to **Off**, you cannot use **Book Center and Edges Erase**.
5. Press **OK**.
  6. Press **Start** on the control panel to begin copying.

## Erasing background images

This feature is helpful when copying originals containing color in the background, as in newspapers or catalogs.

1. Load the originals, face up, in the DADF. Or place a single original face down on the scanner glass.
2. Press **Copy** from the **Main** screen.
3. Press the **Image** tab > **Erase Background**.
4. Select the appropriate option.
  - **Off:** Disables this feature.
  - **Auto:** Optimizes the background.
  - **Enhance:** The higher the number is, the more vivid the background is.
  - **Erase:** The higher the number is, the lighter the background is.
5. Press **OK**.
6. Press **Start** on the control panel to begin copying.

## Shifting margins

You can secure a room for binding by shifting the margin of a page.

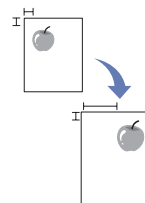

1. Place the originals face up in the DADF. Or place a single original face down on the scanner glass. (See "Loading originals" on page 33.)
2. Press **Copy** from the **Main** screen.
3. Press the **Image** tab > **Margin Shift**
4. Select **Margin Shift** option.
  - **Off**: Disables this feature.
  - **Auto Center**: Adjusts centers of the paper copy automatically. The original must be loaded on the scanner glass to use this feature. This option supports only the original is loaded on the scanner glass.
  - **Custom Margin**: Adjusts the margin of the left and right, top and bottom as you want using arrows. This option supports both on the scanner glass or in DADF.
5. Press **OK**.
6. Press **Start** on the control panel to begin copying.

## Watermark copying

You can copy the original with a watermark. For example, you can use it when you want to have large gray letters such as **Top Secret** or **Confidential** printed diagonally across the first page or all pages of the copy.

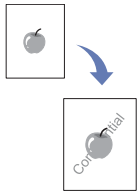

1. Place the originals face up in the DADF. Or place a single original face down on the scanner glass. (See "Loading originals and print media" on page 33.)
2. Press **Copy** from the **Main** screen.
3. Select the tray in **Paper Supply**.
4. Press the **Advanced** tab > **WaterMark**.
5. Select **WaterMark** option.
  - **Off**: Disables this feature.
  - **Top Secret**: Prints the original with **Top Secret** text.
  - **Confidential**: Prints the original with **Confidential** text.
  - **Urgent**: Prints the original with **Urgent** text.
  - **Draft**: Prints the original with **Draft** text.
  - **Custom**: The machine prints the original with the customized text.
6. Select **1st Page only**, **Size**, **Position**, **Darkness** of options.
7. Press **OK**.
8. Press **Start** on the control panel to begin copying.

## Overlay copying

If you scan and store the data such as format, you can copy the original with the previously stored data.

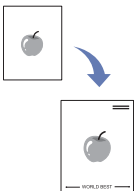

1. Place the originals face up in the DADF. Or place a single original face down on the scanner glass. (See "Loading originals and print media" on page 33.)
2. Press **Copy** from the **Main** screen.
3. Select the tray in **Paper Supply**.
4. Press the **Advanced** tab > **Overlay**.
5. Press **List**.
6. Select a file name.
7. Select an overlay option.
  - **New**: Makes the new overlay. When the file name pops up, enter the file name.
  - **Detail**: Shows information of the selected overlay.
  - **Edit**: Modifies the name of the selected overlay.
  - **Delete**: Deletes the selected overlay.
  - **Apply**: Prints the originals with the selected overlay.
  - **Print**: Prints the selected overlay.
  - **Cancel**: Cancels overlay options you have selected.
8. Press **Start** on the control panel to begin copying.  
If you have selected option **New** in step 7, the machine starts storing the new overlay by pressing the **Start** button.

## Auto crop copying

The machine prints only the image of an original after cropping the blank parts like the margin.

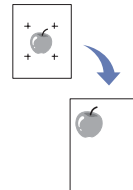

1. Place the originals face up in the DADF. Or place a single original face down on the scanner glass. (See "Loading originals and print media" on page 33.)
2. Press **Copy** from the **Main** screen.
3. Select the tray in **Paper Supply**.
4. Press the **Advanced** tab > **Auto Crop**.
5. Press **On** to activate this feature.
6. Press **OK**.
7. Press **Start** on the control panel to begin copying.

## Multi-Bin

You can choose the output mode for printouts.

 You can only use this feature if you have installed optional 2-Bin Finisher or 4-Bin Mailbox.

1. Press **Copy** from the **Main** screen.
2. Press the **Advanced** tab > **Multi-Bin**.
3. Select the appropriate option.
  - **Mailbox**: Printouts are stacked in the bin you have set. If you set the mailbox to Bin3, printouts will be stacked in Bin3.
  - **Job Separator**: Printouts are stacked in the sequence of job order in each bin. However, if there is a vacant bin left, the vacant bin has priority, which means printouts will be stacked there first.
  - **Collator**: Printouts are stacked in sets to match the sequence of originals in each bin.
  - **Stacker**: Printouts are stacked in bins one-by-one. When Bin1 is full, printouts will be stacked in Bin2.
4. Press **OK**.

# scanning

Scanning with your machine lets you turn pictures and text into digital files that can be stored on your computer. Then you can fax or email the files, upload them to your website, or use them to create projects that you can print.

This chapter gives you information about the scanning method and the different ways to send the scanned file to the destination.

## This chapter includes

- Scanning basics
- Understanding the Scan screen
- Scanning originals and sending through email (Scan to Email)
- Using Scan and Fax Manager 2

 The maximum resolution that can be achieved depends upon various factors, including computer speed, available disk space, memory, the size of the image being scanned, and bit depth settings. Thus, depending on your system and what you are scanning, you may not be able to scan at certain resolutions, especially using enhanced resolution.

## SCANNING BASICS

Scanning with your machine lets you turn hard copy originals into digital files.

There are two ways to scan originals, one is using the USB cable to directly connect the machine with your computer, and the other is using the network scan feature which scans and sends the document to a specific destination via the network.

- **Scan and Fax Manager 2:** You just walk to the machine with the originals and scan them from the control panel. Then, the scanned data will be stored in the connected computers **My Documents** folder. When you install all the softwares in the supplied CD, the Scan and Fax Manager 2 is also automatically installed on your computer. This feature can be used via the local connection or the network connection. (See "Using Scan and Fax Manager 2" on page 53.)
- **TWAIN:** TWAIN is the one of preset imaging applications. Scanning an image launches the selected application, enabling you to control the scanning process. See *Software section*. This feature can be used via the local connection or the network connection. See *Software section*.
- **Samsung SmarThru Office:** This feature is the accompanying software for your machine. You can use this program to scan images or documents, and this feature can be used via the local connection or the network connection. See *Software section*.
- **WIA:** WIA stands for Windows Images Acquisition. To use this feature your computer must be connected directly to the machine with a USB cable. See *Software section*.
- **Email:** You can send the scanned image as an attachment to an email. (See "Scanning originals and sending through email (Scan to Email)" on page 51.)
- **FTP:** You can scan an image and upload it to an FTP server. (See "Scanning originals and sending via SMB/FTP (Scan to Server)" on page 56.)
- **SMB:** You can scan an image and send it to a shared folder on an SMB server. (See "Scanning originals and sending via SMB/FTP (Scan to Server)" on page 56.)

- Scanning by a network connection
- Scanning originals and sending via SMB/FTP (Scan to Server)
- Changing the scan feature settings

## UNDERSTANDING THE SCAN SCREEN

To use the scanning feature, press **Scan** on the **Main** screen. If the screen displays an other menu, press () to go to the **Main** screen.



 If the message asking **Auth. ID** and **Password**, it means the network administrator has set the authentication in **SyncThru Web Service**. (See "Managing your machine from the website" on page 21.)

Press **Scan to Email**, **Scan to PC** or **Scan to Server**.

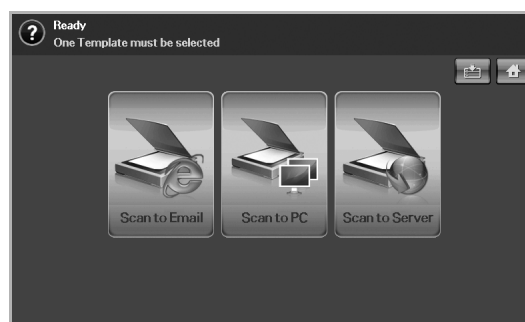

- **Scan to Email:** Scans and sends the scanned output to the destination by email. (See "Scanning originals and sending through email (Scan to Email)" on page 51.)
- **Scan to PC:** Scans and sends the scanned output to the destination with the **Scan and Fax Manager 2** program. (See "Using Scan and Fax Manager 2" on page 53.)
- **Scan to Server:** Scans and sends the scanned output to the destination with **SMB** and **FTP**. (See "Scanning originals and sending via SMB/FTP (Scan to Server)" on page 56.)

## Basic tab

This section explains the **Basic** tab of **Scan to Email** and **Scan to Server**, and **Scan to PC**'s basic screen.

### Scan to Email



- **From:** Sender's email address.
- **To/Cc/Bcc:** Recipients' addresses. **Cc** is for copies to an additional recipient and **Bcc** is for the same as **Cc** but without their name be displayed.
- **Subject/Message:** Subject and message of the email.
- **Remove All:** Erases everything in the input area.
- **Address:** Inputs the recipient's address just by pressing stored addresses. You can store frequently used email addresses from your computer using the **SyncThru Web Service**. (See "Storing email addresses" on page 51.)
- **Duplex:** Selects whether the machine scans on one side of the paper (**1 Sided**), both sides of the paper (**2 Sided**), or both sides of paper but back is rotated 180 degrees (**2 Sided, Rotate Side 2**).
- **Resolution:** Selects the scanning resolution value.
- **Back:** Returns to the previous screen. If the network authentication is enabled, the log off confirmation message pops up and closes **Scan to Email**.

### Scan to PC

If the authentication for network appears, you have to enter user name and password to enter the **Scan to PC** screen.

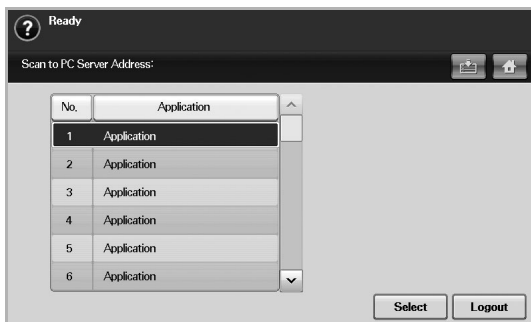

- **No.:** Lists the number in order for application programs.
- **Application:** Shows the available application programs from your computer.
- **Select:** Moves to the application program you have selected.

## Scan to Server

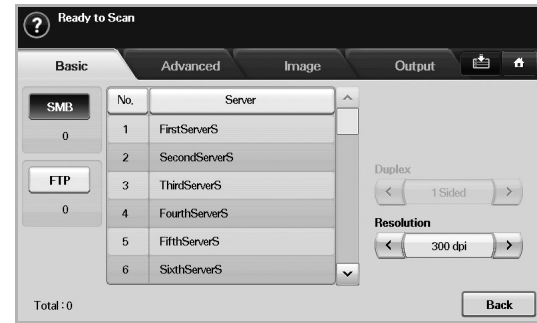

- **SMB:** Sends the scanned file to SMB. Press **SMB** for that option.
- **FTP:** Sends the scanned file to FTP. Press **FTP** for that option.
- **No.:** Index number which you entered in **SyncThru Web Service**. (See "Scanning originals and sending via SMB/FTP (Scan to Server)" on page 56.)
- **Server:** Alias name which you entered in **SyncThru Web Service**. (See "Scanning originals and sending via SMB/FTP (Scan to Server)" on page 56.)
- **Duplex:** Selects whether the machine scans on one side of the paper (**1 Sided**), both sides of the paper (**2 Sided**), or both sides of paper but back is rotated 180 degrees (**2 Sided, Rotate Side 2**).
- **Resolution:** Selects the scanning resolution value.
- **Back:** Returns to the previous screen.

## Advanced tab

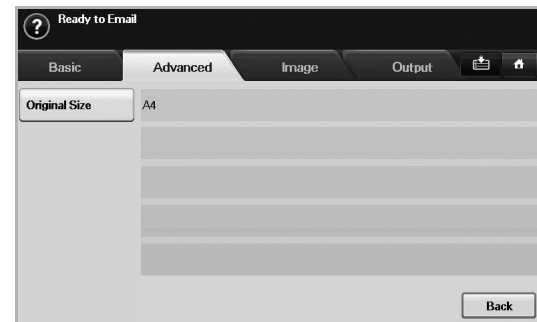

- **Original Size:** Sets the originals to a specific fixed size. (See "Original Size" on page 57.)
- **Back:** Returns to the previous screen.

## Image tab

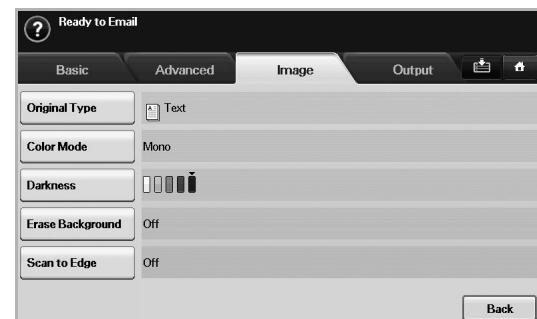

- **Original Type:** Selects whether the original is text or photo. (See "Original Type" on page 57.)



- **Color Mode:** Adjusts the color options of the scan output. If the original is color and you want to scan in color, press **Color Mode**. (See "Color Mode" on page 57.)
- **Darkness:** Adjusts the degree of darkness of the scan output. Use left/right arrow to adjust the values. (See "Darkness" on page 57.)
- **Erase Background:** Erases backgrounds like paper patterns. (See "Erase Background" on page 57.)
- **Scan to Edge:** Scans originals from edge-to-edge. (See "Scan to Edge" on page 58.)
- **Back:** Returns to the previous screen.

## Output tab

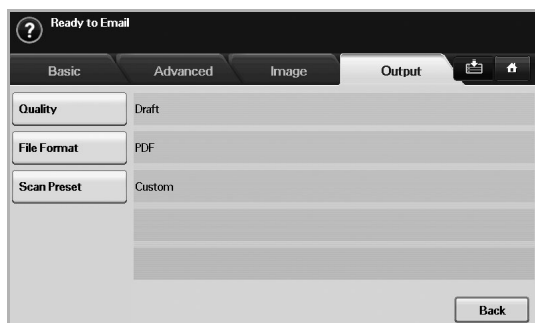

- **Quality:** Adjusts the display quality of the scan output. (See "Quality" on page 58.)
- **File Format:** Selects the file format of the scan output. (See "File Format" on page 58.)
- **Scan Preset:** Automatically changes some scan options such as file format, resolution, and more. You can adjust options to fit each specific purpose. (See "Scan Preset" on page 58.)
- **Back:** Returns to the previous screen.

## SCANNING ORIGINALS AND SENDING THROUGH EMAIL (SCAN TO EMAIL)

You can scan the originals and email the scanned image to several destinations from the machine by email.

### Sending a scanned image to several destinations as an email attachment

1. Place the originals face up in the DADF. Or you can use the scanner glass for one sheet of paper.

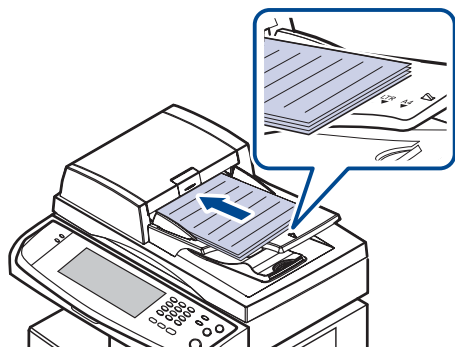

2. Press **Scan** from the **Main** screen.



If the authentication message shows, enter User Name and Password. This message shows only when the network administrator has set the authentication in **SyncThru Web Service**. (See "Managing your machine from the website" on page 21.)

3. Press **Scan to Email**.
4. Set the scan features in the **Advanced**, **Image**, or **Output** tabs. (See "Advanced tab" on page 50.)
5. Press the **Basic** tab to enter the email address.

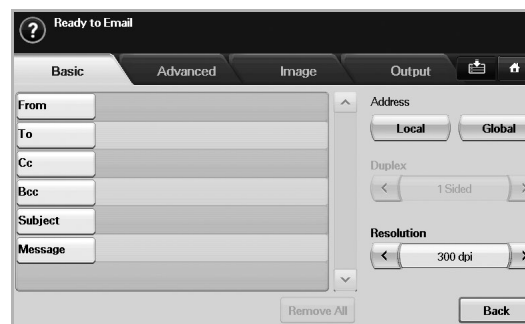

- **From:** Sender's address. Touch **From** and then the keyboard pops up on the screen. Use the pop up keyboard to enter your email addresses. Or you can use **Local** and **Global** to enter the addresses easily. (See "Global" on page 52.)
- **To/Cc/Bcc:** Recipient's email address manually with the pop up keyboard, or by pressing **Local** or **Global**. **Local** or **Global** addresses are pre-loaded address lists from your computer or the LDAP server which is configured at Web UI. (See "Global" on page 52.)
- **Subject:** Title of email.
- **Message:** Enters the text which will be as the contents of the email. The maximum size is 1KB.



To delete previously entered contents, press **Remove All**.

6. Set the scan quality by **Duplex** and **Resolution**.
  - **Duplex:** Sets this option for originals that are printed on one side only, or on both sides.
  - **Resolution:** Sets the scanning resolution by pressing left/right arrows.
7. Press the **Start** button to scan and send the file.



While the machine is sending an email, you cannot do the copy job either sending a fax.

### Storing email addresses

There are two kinds of email addresses - **Local** on your machine's memory and **Global** on the LDAP server - which differ depending on where they are stored. **Local** is that email addresses are stored in the machine's memory, and **Global** is that email addresses are stored in the certain (LDAP) server.

Through the **SyncThru Web Service**, you can easily enter and store email addresses from your computer.

#### Individual

1. Turn your networked computer on and open the web browser.
2. Enter your machine's IP address as the URL in a browser.
3. Click **Go** to access the **SyncThru Web Service**.

- Click **Machine Settings > E-mail Setup > Individual Address Book**. Then the screen shows **Individual Address Book** on the right side of the screen.
- Click **Add**.
- When the **Add E-Mail** screen appears, select the **Index** number, enter **User Name** and **E-mail Address**.
- Click **Apply**.
- Check if the emails are correctly stored and listed on your machine by pressing **Local > the Individual** tab.

### Group

- Access to the **SyncThru Web Service** from your computer.
- Make sure you have configured **Individual Address Book**.
- Click **Machine Settings > E-mail Setup > Group Address Book**. Then the screen shows **Group Address Book** on the right side.
- Click **Add**.
- Select the **Group** number and enter **Group Name**.
- Select email addresses by clicking the check boxes.
- Click **Apply**.
- Check if the email addresses are correctly stored and listed on your machine by pressing **Group**.

### Global

Email addresses which are stored in **Global** in your machine are processed by the LDAP server.

- Turn your networked computer on and open the web browser.
- Enter your machine's IP address as the URL in a browser.
- Click **Go** to access the **SyncThru Web Service**.
- Click **Machine Settings > LDAP Server Setup**. Then the LDAP Server screen shows on the right side.
- Enter **IP Address or Host Name** or **Host Name** and **LDAP server** and **Port**.
- Enter optional information.
- Click **Apply**.

-  The LDAP server administrator must store the email address data. The method of storing is varies depending on the server and the operating systems.

### Entering email addresses by the address book

Once you have stored the frequently used addresses into the address book, you can simply enter email addresses.

- Press **Local** or **Global** from the **Basic** tab of **Scan to Email**.



The search window shows.

- Press the initial alphabet key of the address you are looking for. Or press **Search** to specify the search criteria.

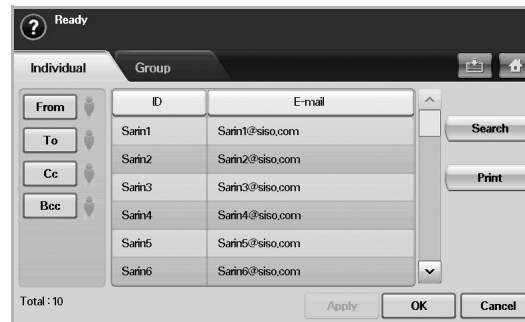

When the search is completed, the screen displays the search results.

- Press **From** and enter your email address and press **OK**.
- Select the address you want in the right-hand pane, and the press **To**, **Cc** or **Bcc** in the left-hand pane.
- Press **Apply**. Keep selecting addresses as many as you want.
- Press **OK**.

### Entering email addresses by the keyboard



When you press the input field in the **From**, **To**, **Cc**, or message input field, the keyboard shows on the display screen.

The following explanation is the example that you are entering "abcdefg@abc.com".

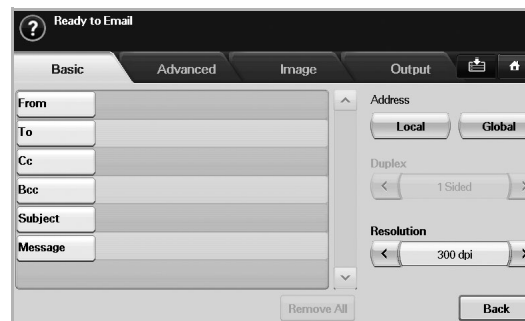
- Press **From** in the **Basic** tab of the **Scan to Email**.



- Press **a, b, c, d, e, f, g**.
- Press **@**.
- Press **a, b, c**.
- Press **.** and press **c, o, m**.

-  To enter contents in other fields, press  on the keyboard.

- Press **OK** after finishing all the contents.



## USING SCAN AND FAX MANAGER 2

If you have installed the printer driver, Scan and Fax Manager 2 program has installed too. Start Scan and Fax Manager 2 program to find out about this program information and the installed scan driver's condition. Through this program, you can change scan settings and add or delete the folders where scanned documents are saved in your computer.

 The **Scan and Fax Manager2** program can only be used in the Window and Macintosh system. If you use the Macintosh, see *Software section*.

1. From the **Start** menu, click **Samsung Printers > Scan and Fax Manager2**.

 You can open **Scan and Fax Manager2** by right clicking the **Smart Panel** icon in the Windows task bar and selecting **Scan and Fax Manager2**.

2. Select the appropriate machine from the **Scan and Fax Manager2** window.
3. Press **Properties**.
4. The **Set Scan Button** tab allows you to change the saving destination and scan settings, add or delete application program, and format files.
5. When setting is done, press **OK**.

### Set Scan Button tab

#### Scan Destination

- **Available Destination List:** Shows the list of applications currently linked to scanned images in the PC's registry. Select the program you want to use and click the right arrow and add to **Front Panel Destination List**.
- **Front Panel Destination List:** Shows the list of applications to open scanned image.
- **Add Application:** Allows you to add application you want to use to **Available Destination List**.
- **Remove Application:** Allows you to remove an item added by the user in the **Available Destination List**.
- **File Format:** Allows you to select the form of scanned data to be saved. You can choose among **BMP**, **JPEG**, **PDF**, and **TIFF**.

### Scan Property

- **Computer ID:** Shows the ID of your computer.
- **Save Location:** Allows you to choose the location of the default saving folder.
- **Resolution:** Allows you to choose the scan resolution.
- **Scan Color:** Allows you to choose the scan color.
- **Scan Size:** Allows you to choose the scan size.
- **ADF Duplex:** Automatically scans both sides. If your model does not support this option, it will be grayed out.
- **Default:** Allows you to go back to default options.

### Scan Assistant

When you press **Quick Scan** in Scan and Fax Manager 2, the **Scan Assistant** window appears. **Scan Assistant** allows you to adjust scan settings and start the scanning process.

In the **Basic** mode, **Scan Settings** and **Preferences** are available only. If you want to use more settings, press **Advanced**.

 Click the **Help** button from the lower-left corner of the window and click on any option you want to know about. Then a pop up window appears with information about that option's feature which is provided from the **Scan Assistant**.

- **Favorites:** Allows you to save the current preferences settings for future use. When you save **Favorites**, all current scan settings are saved. To use a saved setting, select it from the **Favorites** drop down list. The machine is now set to scan according to the setting you selected. To delete saved setting, select it from the **Favorites** drop down list and click **Delete**. To set a favorite as startup, select the favorite you want to set as startup, then click the **Set as default** button.
- **Scan Settings:** The following scan options are available.
  - **Image Type :** Allows you to choose the proper color settings for image scanning.
  - **Resolution:** Allows you to choose the image resolution.
  - **Document Size:** Allows you to choose the proper size of the scanned image.
  - **Document Source:** Allows you to choose the device you want to scan with.
  - **Prompt for additional pages:** If this check box is checked, you can scan pages continuously. This option is useful when you scan multi-page documents and/or when **Document Source** is set to **Flatbed** (scanner glass). In this case a sequence of scanned images is processed as a single document.
  - **Pages to Scan:** Allows you to specify how many pages are to be scanned. This option is available when **Document Source** is set to **ADF Simplex**, **ADF Duplex-Short Edge**, and **ADF Duplex-Long Edge**.
- **Preference:** The following scan options are available.
  - **Auto crop image after preview:** If this option is checked, the scanning area will be automatically adjusted to the image size.
  - **Preview on program start:** If this option is checked, the scanning area will be selected automatically as shown in the preview.
  - **Blank page detection:** This operation automatically detects whether the scanned image is blank or not.
  - **Delete page:** Blank pages will be deleted at the end of the scanning process.
  - **Separate files:** Blank page will work as a scan job separator. That is, when multiple pages are scanned at once a blank page will divide scanned image sequence into parts. Each part will be treated as a separate document (group).
- **Advanced:** In the **Advanced** mode, additional options such as **Image Adjustment**, **Image Enhancement**, and **Additional Settings** are available.

- **Image Adjustment:** Allows you to perform some transformations of the scanned image. These transformations include automatic adjustment of image size, straightening and rotation.
- **Image Enhancement:** Allows you to remove various defects of the image and improve its quality.
- **Additional settings:** Allows special processing of scanned images. These transformations include stitching several partial image scans into a single image, processing of scanned books and watermark stamping.

## SCANNING BY A NETWORK CONNECTION

If you have connected your machine to a network and set up the network parameters correctly, you can scan and send images over the network.

### Preparing for network scanning

Before using your machine's network scanning features, you need to configure the following settings, depending on your scan destination:

- Register as an authorized user for scanning to email, FTP, or SMB
- Set up the SMTP server for scanning to email
- Set up the FTP servers for scanning to FTP
- Set up the SMB servers for scanning to SMB

### User authentication for network scanning

To send an email, FTP, or SMB, you must register authorized local or network users using SyncThru Web Service.

- If user authentication has been activated, only authorized local users or on the DB server (SMB, LDAP, Kerberos) can send scanned data to the network (email, FTP, SMB).
- For network scanning using the authentication feature, you must register the network or local authentication configuration using the SyncThru Web Service.
- User authentication has 3 options: none (Default), network authentication, and local authentication.

### Registering local authorized users

1. Enter your machine's IP address as the URL in a browser and click **Go** to access the web site of your machine.
2. Click **Machine Settings**.
3. Select **Local Authentication** on the **General Setup** of the **User Authentication** web page.
4. Click **Add**.
5. Select an index number corresponding to the location for storing the entry, from 1 to 50.
6. Enter your name, auth ID, password, e-mail address and phone number.  
You need to enter the registered user ID and password in the machine when you start scanning to email from the control panel.
7. Click **Apply**.

### Register authorized network users

1. Enter your machine's IP address as the URL in a browser and click **Go** to access the web site of your machine.
2. Click **Machine Settings**.
3. Select **Network Authentication** on the **General Setup** of **User Authentication** web page.
4. Click **Apply** and **OK**.
5. Select the **Authentication Type** that you prefer.
6. Configure the values for each feature, as follows.
7. Click **Apply**.

### Network user authenticated by Kerberos

1. Enter the realm used for **Kerberos** login.
2. Select **IP Address** or **Host Name**.
3. Enter the IP address in dotted decimal notation or as a host name.
4. Enter the server port number, from 1 to 65535.  
The default port number is 88.
5. You can add a backup domain as a previous step.
6. Click **Apply**.

### Network user authorized by SMB

1. Enter the domain that is used for **SMB** login.
2. Select **IP Address** or **Host Name**.
3. Enter the IP address in dotted decimal notation or as a host name.
4. Enter the server port number, from 1 to 65535.  
The default port number is 139.
5. User can add a backup domain as in the previous step.
6. Click **Apply**.



User can add up to 6 alternate domains.

### Network authorized user by LDAP

1. Enter your machine's IP address as the URL in a browser and click **Go** to access the web site of your machine.
2. Click **Machine Settings** and **LDAP Server Setup**.
3. Select **IP Address** or **Host Name**.
4. Enter the IP address in dotted decimal notation or as a host name.
5. Enter the server port number, from 1 to 65535.  
The default port number is 389.
6. Enter **Search Root Directory**, the top search level of the LDAP directory tree.
7. Select **Authentication method**. Two options for LDAP server login.  
**Anonymous:** This is used to bind with null password and login ID (Password and login ID are grayed out in SWS).  
**Simple:** This is used to bind with the login ID and password in SWS.
8. Check the box next to **Append Root to Base DN**.
9. Select **Match User's Login ID to the following LDAP attribute** (options are CN, UID, or UserPrincipalName).
10. Enter your login name, password, maximum number of search results and search timeout.



**LDAP Referral:** LDAP client will search referral server if the LDAP server has no data to reply to query and if the LDAP server has a referral server.

11. Select **Search Name Order** that you desire.
12. Check the box next to **"From:" Field Security Options**.



This option is only provided if you have selected the Network authentication option in the user authentication setting. You may check this option if you want to search for information in a default email address group.

13. Click **Apply**.

### Setting up an e-mail account

To scan and send an image as an email attachment, you need to set up network parameters using SyncThru Web Service.

1. Enter your machine's IP address as the URL in a browser and click **Go** to access the web site of your machine.
2. Click **Machine Settings** and **E-mail Setup**.
3. Select **IP Address** or **Host Name**.

4. Enter the IP address in dotted decimal notation or as a host name.
5. Enter the server port number, from 1 to 65535.  
The default port number is 25.
6. Check the box next to **SMTP Requires Authentication** to require authentication.
7. Enter the SMTP server login name and password.
8. Click **Apply**.



If the authentication method of SMTP server is POP3beforeSMTP, check the box next to **SMTP Requires POP3 Before SMTP Authentication**.

- a. Enter the IP address in dotted decimal notation or as a host name.
- b. Enter the server port number, from 1 to 65535. The default port number is 25.

### Setting up an FTP server

To use an FTP server, you need to set up parameters to access the FTP servers using SyncThru Web Service.

1. Enter your machine's IP address as the URL in a browser and click **Go** to access the web site of your machine.
2. Click **Machine Settings** and **FTP Setup**.
3. Click **Server List**.
4. Click **Add**.
5. Select the index number, from 1 to 20.
6. Enter a name in **Alias for the Setup** for the corresponding Server List entry. This name will be displayed on your machine.
7. Select **IP Address** or **Host Name**.
8. Enter the server address in dotted decimal notation or a host name.
9. Enter the server port number, from 1 to 65535.  
The default port number is 21.
10. Check the box next to **Anonymous** if you want the FTP server to permit access to unauthorized persons.  
It is unchecked by default.
11. Enter the login name and password.
12. Enter the **Scan File Folder** under FTP directory for saving the scanned image.
13. Click **Apply**.

### Setting up an SMB server

To use an SMB server, you need to set up parameters for access to SMB servers using SyncThru Web Service.

1. Enter your machine's IP address as the URL in a browser and click **Go** to access the web site of your machine.
2. Click **Machine Settings** and **SMB Setup**.
3. Click **Server List**.
4. Click **Add**.
5. Select the index number, from 1 to 20.
6. Enter a name in **Alias for the Setup** for the corresponding Server List entry. This name will be displayed on your machine.
7. Select **IP Address** or **Host Name**.
8. Enter the server address in dotted decimal notation or a host name.
9. Enter the server port number, from 1 to 65535.  
The default port number is 139.
10. Enter the **Share name** of the server.
11. Check the box next to **Anonymous** if you want to permit unauthorized persons to access the SMB server.  
This box is unchecked by default.

12. Enter the login name and password.
13. Enter the domain name of the SMB server.
14. Enter the **Scan File Folder** under shared folder for storing the scanned image.
15. Click **Apply**.

## SCANNING ORIGINALS AND SENDING VIA SMB/FTP (SCAN TO SERVER)

You can scan an image and send it to a total of 5 destinations via the SMB or FTP.

### Preparation for scanning to SMB/FTP

Select the folder and share it with the machine in order to receive the scanned file.

 The next steps are for SMB server setting using **SyncThru Web Service**, and the setting for FTP server is the same as SMB. Apply the same steps for setting up the FTP server.

1. Turn your networked computer on and open the web browser.
2. Enter your machine's IP address as the URL in a browser.
3. Click **Go** to access the **SyncThru Web Service**.
4. Click **Machine Settings > SMB Setup > Server List**. The **Server List** is then displayed on the right side of the screen.
5. Click **Add**.
6. Select the index number from 1 to 20.
7. Enter a name in **Alias for the Setup** for the corresponding **Server List** entry. This name will be displayed on your machine.
8. Select **IP Address or Host Name**.
9. Enter the server address in dotted decimal notation or a host name.
10. Enter the server port number, from 1 to 65535.  
The default port number is 139.
11. Enter the share name of the server.
12. Put a check mark next to in **Anonymous** if you want to allow the SMB server to be accessed by unauthorized persons.  
By default, this is unchecked.
13. Enter the login name and password.
14. Enter the domain name of the SMB server.
15. Enter the location for storing the scanned image. This is the location you entered in step 7..
16. Click **Apply**.

### Scanning and sending to SMB/FTP server

1. Press **Scan** from the **Main** screen.

 If the authentication message shows, enter User Name and Password. This message shows only when the network administrator has set the authentication in **SyncThru Web Service**. (See "Managing your machine from the website" on page 21.)

2. Press **Scan to Server**.
3. Place the originals face up in the DADF. Or you can place a single original document face down on the scanner glass.
4. Adjust the document settings in the **Image** tab.
5. Select **Duplex** and **Resolution** in the **Basic** tab.

6. Press **Scan to Server** to show the SMB server list you entered in the **SyncThru Web Service**.

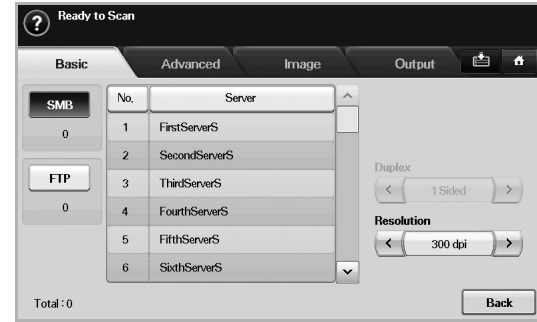

7. Select the destination SMB server.

 You can select up to five destinations using both of SMB or FTP servers.

8. Press **Start** on the control panel.

The machine begins scanning and then sends the scanned image to the specified server.

## CHANGING THE SCAN FEATURE SETTINGS

This part explains how to adjust the document settings for each scan job, such as resolution, duplex, original size, type, color mode, darkness, and more. The options you change will be maintained for a certain time, but after that period, the options will be reset to default values.

### Duplex

This feature especially applies when the original documents to be scanned are two-sided. You can select whether the machine scans only one side of the paper or both sides of the paper.

Press **Scan > Scan to Email (Or Scan to Server) > the Basic tab > Duplex**. Use left/right arrows to toggle the values.

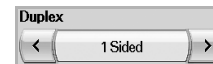

- **1 Sided**: For originals that are printed on one side only.
- **2 Sided**: For originals that are printed on both sides.
- **2 Sided, Rotate Side 2**: For originals that are printed on both sides. But the back is rotated 180 degrees.

 To use **2 Sided** and **2 Sided, Rotate Side 2**, you have to load the originals on the DADF. Because, if the machine can not detect the original on DADF, automatically changes the option to **1 Sided**.

### Resolution

You can adjust document resolution.

Press **Scan > Scan to Email (Or Scan to Server) > the Basic tab > Resolution**. Use left/right arrows to toggle the values. The higher value you select the clear result you get. But the scanning time may take longer.

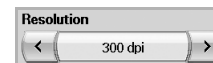

100, 200, 300 dpi resolution is available only when **Color Mode** is set to **Color** or **Gray**. The following table shows detailed information feature, resolution and file format options.

FEATURE	RESOLUTION (DPI)	FILE FORMAT
Scan to Email	100, 200, 300, 400, 600	PDF, Single-Page TIFF, Multi-Page TIFF, JPEG
Scan to PC	100, 200, 300, 400, 600	PDF, TIFF, JPEG
Scan to Server	100, 200, 300, 400, 600	PDF, Single-Page TIFF, Multi-Page TIFF, JPEG

## Original Size

You can specify the scanning area on the originals by selecting the pre-defined size, or putting in the margin value or **Auto**. If you set this option to **Auto**, the machine senses and determines the size of the original.

Press **Scan > Scan to Email (Or Scan to Server) > the Advanced tab > Original Size**. Use up/down arrows to go to the next screen. Select the appropriate option and press **OK**.

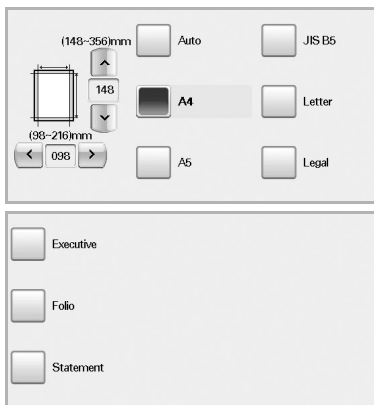

## Original Type

You can set the original document type in order to enhance the quality of a document being scanned.

Press **Scan > Scan to Email (Or Scan to Server) > the Image tab > Original Type**. Select the appropriate option and press **OK**.



- **Text:** For originals that have text or line art.
- **Text/Photo:** For originals that have both text and photographs together.
- **Photo:** For originals that are continuous tone photographs.

## Color Mode

Use this option to scan the original in **Mono**, **Gray** or **Color** mode.

Press **Scan > Scan to Email (Or Scan to Server) > the Image tab > Color Mode**. Select the appropriate option and press **OK**.



- **Color:** Uses color to display an image. 24 bits per pixel, 8 bits for each RGB, is used for 1 pixel.
- **Gray:** Uses the black gradation to display an image. 8 bits per pixel.



- **Mono:** Displays an image in black and white. 1 bit per pixel.



 The file format JPEG cannot be selected if **Mono** has been selected for **Color Mode**.

## Darkness

You can select the degree of darkness of the scanned output. If your original document is light or faded, press the right arrow to make the output darker.

Press **Scan > Scan to Email (Or Scan to Server) > the Image tab > Darkness**. Press right arrow to enhance the darkness degree then, press **OK**.



## Erase Background

You can lighten, reduce or deletes the dark background from scanning colored paper or newspaper originals.

Press **Scan > Scan to Email (Or Scan to Server) > the Image tab > Erase Background**. Select the appropriate option and press **OK**.

- **Off:** Disables this feature.
- **Auto:** Optimizes the background.
- **Enhance:** The higher the number is, the more vivid the background is.
- **Erase:** The higher the number is, the lighter the background is.



## Scan to Edge

You can set the machine to scan full size of a page as it is. Usually, the machine scans a page except edges, which means the margin, especially when you do the copy job with certain sized paper in the tray. But if you scan and sent it right away via the network, as the file, the machine does not need to exclude the edges from the originals.

Press **Scan > Scan to Email (Or Scan to Server)** > the **Image** tab > **Scan to Edge**. Select **On** and press **OK**.

## Quality

You can use this option to produce a high quality document. Higher quality you select a larger file size you get.

Press **Scan > Scan to Email (Or Scan to Server)** > the **Output** tab > **Quality**.



 When you set **Color Mode** to **Mono**, the **Quality** option is grayed out.

## File Format

You can select the file format before you proceed with the scanning job.

Press **Scan > Scan to Email (Or Scan to Server)** > the **Output** tab > **File Format**.



- **PDF**: Scans originals in PDF format.
- **Single-Page TIFF**: Scans originals in TIFF (Tagged Image File Format), but several originals are scanned as one file.
- **Multi-Page TIFF**: Scans the originals in TIFF (Tagged Image File Format), and several originals are scanned as several file.
- **JPEG**: Scans original in JPEG format.

 The file format JPEG cannot be selected if **Mono** has been selected for **Color Mode**.

## Scan Preset

This feature allows you to use optimized settings for your specific scan job. Press **Scan > Scan to Email (Or Scan to Server)** > the **Output** tab > **Scan Preset**.

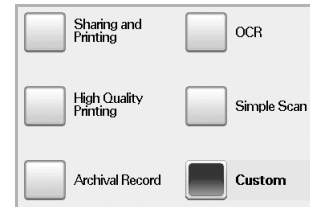

- **Sharing and Printing**: Produces a small-sized file for normal quality documents.
- **High Quality Printing**: Set this option for high quality output with the largest file size.
- **Archival Record**: For the electronic file which is of the smallest file size of the output.
- **OCR**: Produces scanned output for OCR software. You can expect the highest quality images.
- **Simple Scan**: Used for a simple document with text only. The file size of output is small.
- **Custom**: Applies the current scan settings that you have chosen.



# basic printing

---

This chapter explains common printing tasks.

**This chapter includes:**

- Printing a document
- Canceling a print job

## PRINTING A DOCUMENT

---

Your machine allows you to print from various Windows, Macintosh, or Linux applications. The exact steps for printing a document may vary depending on the application you use.

For details about printing, see *Software section*.

## CANCELING A PRINT JOB

---

If the print job is waiting in a print queue or print spooler, such as the printer group in Windows, delete the job as follows:

1. Click the Windows **Start** menu.
2. For Windows 2000, select **Settings** and then **Printers**.  
For Windows XP/2003, select **Printers and Faxes**.  
For Windows Vista/2008, select **Control Panel > Hardware and Sound > Printers**.  
For Windows 7, select **Control Panel > Hardware and Sound > Devices and Printers**.  
For Windows Server 2008 R2, select **Control Panel > Hardware > Devices and Printers**.
3. For Windows 2000, XP, 2003, 2008 and Vista, double-click your machine.  
For Windows 7 and Windows Server 2008 R2, right click your printer icon > context menus > **See what's printing**.
4. From the **Document** menu, select **Cancel**.



You can also access this window by simply double-clicking the printer icon at the bottom right corner of the Windows desktop.

You can also cancel the current job by pressing **Stop** on the control panel.

# faxing (optional)

This chapter gives you information about using your machine as a fax machine.

## This chapter includes:

- Preparing to fax
- Understanding the Fax screen
- Sending a fax
- Receiving a fax
- Adjusting the document settings
- Setting up a fax phonebook

- ✎ You cannot use this machine as a fax via the internet phone. For more information ask the internet service provider.
- You may experience restrictions on color fax transmission, slower fax transmission, poor fax quality and communication failures when faxing over VoIP network. Contact your local network administrator or Internet Service Provider for more details.
- To use advanced features of the fax, press **Machine Setup** on the control panel and **Admin Setting > Setup > Fax Setup**. (See "Fax Setup" on page 78.)
- We recommend you to use traditional analog phone services (PSTN: public switched telephone network) when connecting telephone lines to use Fax. If you use other Internet services (DSL, ISDN, VoIP), you can improve the connection quality by using the Micro-filter. The Micro-filter eliminates unnecessary noise signals and improves connection quality or Internet quality. Since the DSL Micro-filter is not provided with the machine, contact your Internet Service provider for use on DSL Micro-filter.

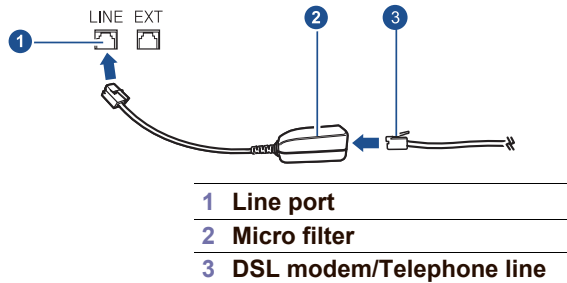

## PREPARING TO FAX

Before you send or receive a fax, you need to connect the supplied line cord to the wall jack. Refer to the Quick Install Guide how to make a connection. The method of making a telephone connection is varies from one country to another.

- ✎ If you want to add fax feature to the machine, check the option lists (See "Fax option kit" on page 110.) and contact the purchasing point to order. When you purchase a fax kit, install the kit by following the steps described in the Fax Kit Setup Guide which is enclosed in the kit. After installing the fax kit, set the machine to use this feature. (See "Enabling Fax feature after installing the fax option kit" on page 114.)

- Using the polling option
- Using Mailbox
- Printing a report after sending a fax
- Sending a fax in toll save time
- Adding documents to a reserved delay fax job
- Forwarding a received fax to other destination

## UNDERSTANDING THE FAX SCREEN

To use the fax feature, press **Fax** on the **Main** screen. If the screen displays an other menu, press ( ) to go to the **Main** screen.



- ✎ If the optional fax feature is not installed the fax icon will not appear on the **Main** screen.

## Basic tab

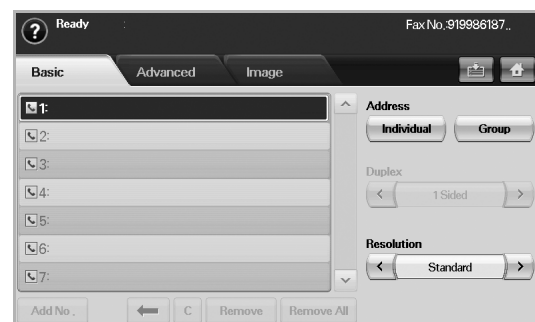

- **Fax number input area:** Shows the recipient's fax number using the number keypad on the control panel. If you configured the phone book, press **Individual** or **Group**. (See "Setting up a fax phonebook" on page 64.)
- **Add No.:** Lets you add more destinations.
- : Deletes the last digit entered.
- : Removes all digits of the selected entry.
- **Remove:** Removes the selected fax number entry.
- **Remove All:** Removes all the fax numbers in the input area.
- **Address:** Picks up the frequently used fax numbers directly from your machine or from **SyncThru Web Service**. (See "Setting up a fax phonebook using SyncThru Web Service" on page 65.)

- **Duplex:** Selects whether the machine send faxes one side of the original, both sides of the original.
- **Resolution:** Adjusts the resolution options.

## Advanced tab

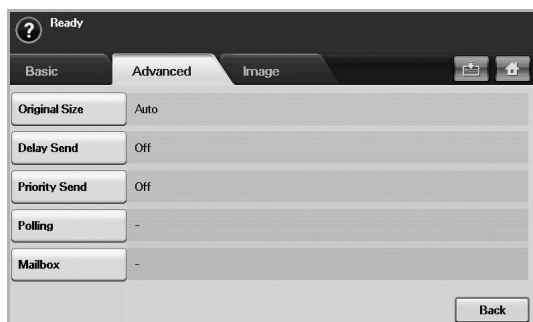

- **Original Size:** Selects the size of the original document. Press **OK** to update current setting.
- **Delay Send:** Sets the machine to send a fax at a later time without your intervention. (See "Delaying a fax transmission" on page 62.)
- **Priority Send:** Sends an urgent fax before reserved operations. (See "Sending a priority fax" on page 63.)
- **Polling:** Used when the receiver requests the document to be faxed remotely at sender's absence or vice versa. In order to use the polling function, the originals must be previously stored in the machine. (See "Using the polling option" on page 65.)
- **Mailbox:** Used to store a received fax or originals in the machine memory which are ready to be polled. You can use a mailbox on the same machine you are using, or the one on a remote machine. Each mailbox has a corresponding mailbox number, name and password. (See "Using Mailbox" on page 66.)
- **Back:** Returns to the **Basic** tab.

## Image tab

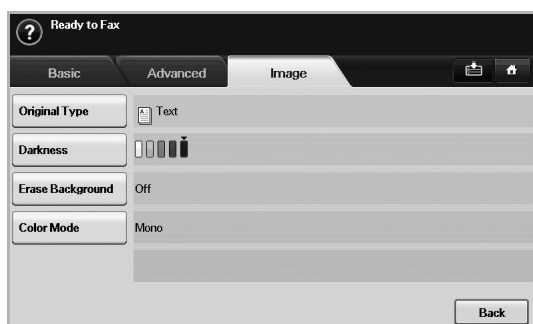

- **Original Type:** Enhances the fax quality based on the type of the original document being scanned. (See "Original Type" on page 64.)
- **Darkness:** Adjusts the level of lightness or darkness of the fax. (See "Darkness" on page 64.)
- **Erase Background:** Reduces dark backgrounds or paper patterns as in newspaper originals. (See "Erase Background" on page 64.)
- **Color Mode:** Selects whether the user sends the fax in mono or color. (See "Color Mode" on page 64.)
- **Back:** Returns to the **Basic** tab.

## SENDING A FAX

This part explains how to send a fax, and the special methods of transmission.

- When you place the originals, you can use either the DADF or the scanner glass. (See "Loading originals" on page 33.) If the originals are placed on both the DADF and the scanner glass, the machine will read the originals on the DADF first, which has higher priority in scanning.

### Setting the fax header

In some countries, you are required by law to indicate your fax number on any fax you send.

1. Press **Machine Setup** on the control panel.
2. Press **Admin Setting**. When the login message pops up, enter password and press **OK**. (See "Setting the authentication password" on page 30.)
3. Press the **Setup** tab > **Fax Setup** > **Machine ID & Fax No.**
4. Touch the input area to enter the machine name and your fax number.
5. Press **OK**.

### Sending a fax

1. Press **Fax** from the **Main** screen.
2. Place the originals face up in the DADF.

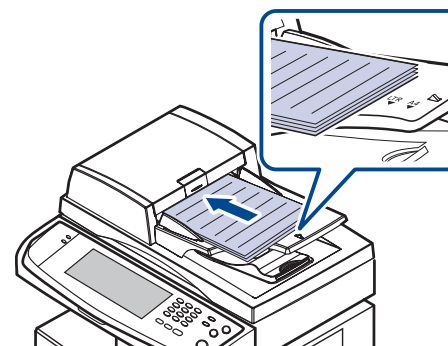

3. Adjust the document settings in the **Image** tab.
4. Select **Duplex** and **Resolution** options in the **Basic** tab.
  - If the originals are printed on both sides of the paper, select **2 Sided** with left/right arrows in the **Duplex** feature.
5. When the cursor is blinking in the input line, enter the fax number using the number keypad on the control panel. Or use Address on the right side of the screen, if you have stored frequently used fax numbers.



6. To add a number, press **Add No.**

- Press **Start** on the control panel. The machine starts to scan and send a fax to destinations.

-  When you want to cancel a fax job, press **Stop** before the machine start transmission. Or press the **Job Status** button, and select the job you want to delete, press **Delete**.
- If you used the scanner glass, the machine shows the message asking to place another page.
- While the machine is sending a fax, you can not send an email at the same time. (See "Scanning originals and sending through email (Scan to Email)" on page 51.)

## Sending a fax manually (On Hook Dial)

- Press **Fax** from the **Main** screen.
- Place the originals face up into the DADF.

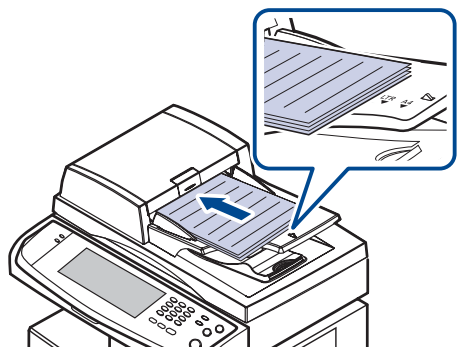

- Adjust the document settings in the **Image** tab.
- Select **Duplex** and **Resolution** options in the **Basic** tab.
- Press **On Hook Dial** on the control panel.
- Enter a fax number using the number keypad on the control panel.
  - If the number is which you have dialed recently, press the **Redial/Pause** button on the control panel to show ten recent fax numbers and select a fax number.
- Press **Start** when you hear a high-pitched fax signal from the remote fax machine.

-  Color faxes are only supported when faxes are sent manually. (See "Color Mode" on page 64.)

## Automatic resending

When the number you have dialed is busy or there is no answer, the machine automatically redials the number.

To change the time interval between redials and/or the number of redial attempts, refer to the next following steps.

- Press **Machine Setup** on the control panel.
- Select **Admin Setting**. When the login message pops up, then enter password and press **OK**. (See "Setting the authentication password" on page 30.)
- Press the **Setup** tab > **Fax Setup**.
- Press **Redial**.

- Select **Redial Term** and **Redial Times**.



- Press **OK**.

## Redialing the last number

- Press **Fax** from the **Main** screen.
- Adjust the document settings in the **Image** tab.
- Place the originals face up into the DADF.
- Press the **Redial/Pause** button on the control panel to show ten recent fax numbers.
- Select a fax number in the list and press **OK**.  
The machine automatically begins to send.

## Delaying a fax transmission

You can set your machine to send a fax at a later time when you will not be present.

- Press **Fax** from the **Main** screen.
- Place the originals face up in the DADF.
- Adjust the document settings in the **Image** tab and the **Basic** tab.
- Press the **Advanced** tab > **Delay Send**.
- Press **On**.
- Enter **Job Name** using the keyboard on the display, select **Start Time** with left/right arrows.

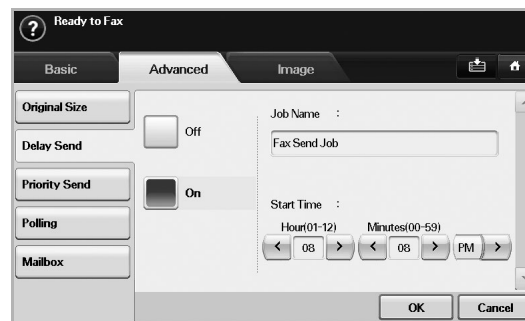

- If you do not enter **Job Name**, the machine assigns the job name as 'Fax Send Job xxx'. 'xxx' number are set in order.

-  **Start Time** is the specific time you want the fax to be sent. You can set **Start Time** on a 24 hour basis and 15 minutes later than the current time. For example, if it is 1:00, then you can set the time starting from 1:15. If the set time is incorrect, the warning message will appear and the machine resets it to the current time.

- Press **OK** to start storing the scanned original data into memory.

-  To cancel delaying a fax, press **Off** before sending is activated.

## Sending a priority fax

This function is used when a high priority fax need to be sent ahead of reserved operations. The original is scanned into memory and immediately transmitted when the current operation is finished. In addition, priority transmission will interrupt a sending to multiple destinations between stations (example, when the transmission to station A ends, before transmission to station B begins) or between redial attempts.

1. Press **Fax** from the **Main** screen.
2. Place the originals face up in the DADF.
3. Adjust the document settings in the **Image** tab and the **Basic** tab.
4. Press the **Advanced** tab > **Priority Send**.
5. Press **On**.
6. Press **OK**.
7. Press **Start** to start the urgent fax job.

## RECEIVING A FAX

This section explains how to receive a fax, and the special receiving methods available.

### Changing the receive modes

Your machine is preset to **Fax** mode at the factory. When you receive a fax, the machine answers the call on a specified number of rings and automatically receives the fax. But if you want to change the **Fax** mode to another mode, refer to next steps.

1. Press **Machine Setup** on the control panel.
2. Select **Admin Setting**. When the login message pops up, then enter password and press **OK**. (See "Setting the authentication password" on page 30.)
3. Press the **Setup** tab > **Fax Setup** > **Fax Initial Setup** > **Receive Mode**.
4. Select the option.
  - **Telephone**: Receives a fax by pressing **On Hook Dial** and then **Start**.
  - **Fax**: Answers an incoming fax call and immediately goes into the fax reception mode.
  - **Answering Machine/Fax**: Is for when an answering machine attached to your machine. Your machine answers an incoming call, and the caller can leave a message on the answering machine. If the fax machine senses a fax tone on the line, the machine automatically switches to **Fax** mode to receive the fax.
5. Press **OK**.

 When the memory is full, the machine can no longer receive any incoming fax. Secure free memory to resume by removing data stored in the memory.

### Receiving manually in Telephone mode

You can receive a fax call by pressing **On Hook Dial** and then pressing **Start** when you hear a fax tone from the remote machine. The machine begins receiving a fax.

### Receiving automatically in Answering Machine/Fax mode

To use this mode, you must attach an answering machine to the EXT socket on the back of your machine. (See "Rear view" on page 18.)

If the caller leaves a message, the answering machine stores the message as it would normally. If your machine detects a fax tone on the line, it automatically starts to receive the fax.



- If you have set your machine to this mode and your answering machine is switched off, or no answering machine is connected to EXT socket, your machine automatically goes into Fax mode after a predefined number of rings.
- If your answering machine has a user-selectable ring counter, set the machine to answer incoming calls within 1 ring.
- If you are in Telephone mode when the answering machine is connected to your machine, you must switch off the answering machine, or the outgoing message from the answering machine will interrupt your phone conversation.
- While the machine is receiving a fax, you can not do the copy job.

## Receiving faxes manually using an extension telephone

This feature works best when you are using an extension telephone connected to the EXT socket on the back of your machine. You can receive a fax from someone you are talking to on the extension telephone, without going to the fax machine.

When you receive a call on the extension phone and hear fax tones, press the keys **\*9\*** on the extension phone. The machine receives the fax.

Press the buttons slowly in sequence. If you still hear the fax tone from the remote machine, try pressing **\*9\*** once again.

To change the **\*9\*** to, for example, **\*3\***, follow the next steps.

1. Press **Machine Setup** on the control panel.
2. Select **Admin Setting**. When the login message pops up, then enter password and press **OK**. (See "Setting the authentication password" on page 30.)
3. Press the **Setup** tab > **Fax Setup** > **Receive Start Code**.
4. Select **On**.
5. Press left/right arrows to display number 9.

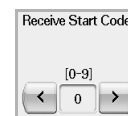

6. Press **OK**.

### Receiving in secure receiving mode

You may need to prevent your received faxes from being accessed by unauthorized people. You can turn on secure receiving mode to restrict printing of received faxes when the machine is unattended. In secure receiving mode, all incoming faxes go into memory.

1. Press **Machine Setup** on the control panel.
2. Select **Admin Setting**. When the login message pops up, then enter password and press **OK**. (See "Setting the authentication password" on page 30.)
3. Press the **Setup** tab > **Fax Setup** > **Secure Receive**.
4. Select **On**.
5. Enter passcode with 4 digit number using the number keypad on the control panel.



To deactivate the **Secure Receive** feature, press **Off**. In this case, the received fax will be printed out.



## Receiving faxes in memory

Since your machine is a multi-tasking device, it can receive faxes while you are making copies or printing. If you receive a fax while you are copying or printing, your machine stores incoming faxes in its memory. Then, as soon as you finish copying or printing, the machine automatically prints the fax.

## ADJUSTING THE DOCUMENT SETTINGS

Before sending a fax, you can adjust the document settings, such as resolution, darkness, color, duplex and so forth. Refer to explanation of this section.

 The document setting herein is for only current job. If you want to change the default setting on document settings, refer to **Admin Setting > General tab > Default Settings**. (See "General settings" on page 76.)

### Duplex

This function is especially intended for two-sided originals. You can select whether the machine sends the fax on one side or both sides of the paper.

Load the originals onto the DADF to use this function.

Press **Fax > the Basic tab > Duplex**. Use left/right arrows to toggle the value.

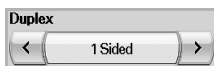

- **1 Sided:** Is for the originals that are printed on one side only.
- **2 Sided:** Is for the originals that are printed on both sides.

### Resolution

Changing the resolution setting affects the appearance of the received document.

Press **Fax > the Basic tab > Resolution**. Use left/right arrows to toggle the values.

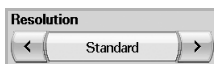

- **Standard:** Usually recommended for originals with text. This option will reduce the transmission time.
- **Fine:** Recommended for the originals containing with small characters, thin lines, or text that was printed using a dot-matrix printer.
- **Super Fine:** Recommended for originals containing with extremely fine detail, this option is enabled only if the receiving machine also supports a **Super Fine** resolution.

 For memory transmission, **Super Fine** mode is not available. The resolution setting is automatically changed to **Fine**.

### Original Type

You can set the original document type to enhance the quality of a document being scanned.

Press **Fax > the Image tab > Original Type**. Select the appropriate option on the screen and press **OK**.

- **Text:** For originals with text or line art.
- **Text/Photo:** For originals with both text and photographs together.
- **Photo:** For originals that are continuous tone photographs.

### Darkness

You can select the degree of darkness of the original document.

Press **Fax > the Image tab > Darkness**. Press the right arrow to enhance the darkness degree and press **OK**.



### Erase Background

You can lighten, reduce or delete the dark backgrounds from scanned colored paper or newspaper originals.

Press **Fax > the Image tab > Erase Background**. Select the appropriate option and press **OK**.

- **Off:** Disables this feature.
- **Auto:** Optimizes the background.
- **Enhance:** The higher the number is, the more vivid the background is.
- **Erase:** The higher the number is, the lighter the background is.

 **Erase Background** is disabled if the **Original Type** is set to **Photo**.

### Color Mode

You can transmit a fax in color using this feature. But this feature only applies when you send a fax using **On Hook Dial** on the control panel.

Press **Fax > the Image tab > Color Mode**. Select option and **OK**.

- **Mono:** Transmits a fax in black and white.
- **Color:** Transmits a fax in color.

 **Color Mode** faxes are only supported when faxes are sent manually. (See "Sending a fax manually (On Hook Dial)" on page 62.)

## SETTING UP A FAX PHONEBOOK

Use this feature to store destination names, fax numbers and transmission settings in your machine. There are two options, **Individual** and **Group**.



- **Individual:** Stores up to 200 fax numbers. And the fax numbers which are stored in Individual work as **Speed Dial No.**
- **Group:** Makes groups when you frequently send the same document to several destinations. You can store up to 100 group dial numbers. Entries stored here will be available for selection within the sending list on the **Basic** tab of **Fax**. Dialing **Group** can be also setup comprising of many Individual entries.

The fax numbers, which are stored in **Individual**, work as **Speed Dial No.**



## Storing individual fax numbers (Speed Dial No.)

1. Press **Fax** > the **Basic** tab > **Individual**.



- **Edit:** Changes the **ID**, **Speed Dial No.**, and **Fax No.**.
  - **New:** Creates the new **Speed Dial No.**.
  - **Delete:** Deletes the selected **Speed Dial No.**.
  - **Search:** Searches the fax number which currently stored in Individual phonebook. When the keyboard pops up, enter **ID**.
  - **Detail:** Shows **ID**, **Fax No.** and Included group information if it is grouped. (See "Storing individual fax numbers (Speed Dial No.)" on page 65.)
  - **Apply:** Inputs the selected fax number to the sending fax number list in the **Basic** tab.
  - **Cancel:** Cancels the current job and goes to the previous screen.
2. Press **New**.
  3. Enter the name of the fax number in the **ID** field with the pop up keyboard, and the fax number in the **Fax No.** area using the number keypad on the control panel.

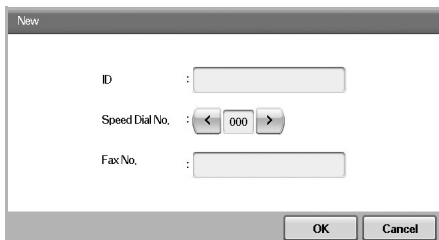

- **ID:** Enters the name.
  - **Speed Dial No.:** Is automatically filled with the first free number. If you want to assign to a different number, use left/right arrows.
  - **Fax No.:** Enters a fax numbers, only the numbers, with the area code if necessary.
4. Press **OK**.

## Storing Group fax numbers (Group No.)

1. Press **Fax** > the **Basic** tab > **Group**.
2. Press **New**.
3. Press the input area in **Group Dial ID**, then the keyboard pops up, enter the name.
4. Select **Group Dial No.** with left/right arrows.

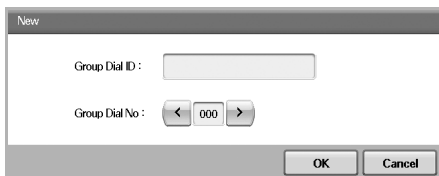

- **Group Dial ID:** Enters the group name.
  - **Group Dial No.:** Is automatically filled with the first free number. If you want to assign to a different number, use left/right arrows.
5. Press **OK**.
  6. Select an entry from **Speed Dial List**, and press **Add**. Repeat this step until you added entries you need.

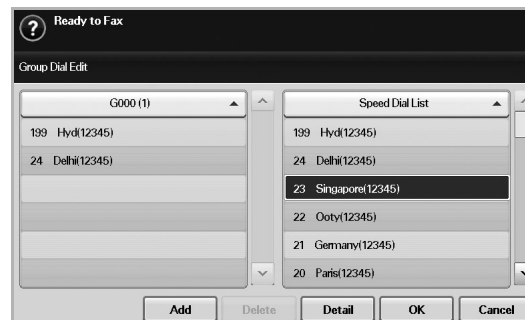



Make sure the selected **Speed Dial List** is copied to the left pane, Group list.

7. Press **OK** to save the numbers.

## Setting up a fax phonebook using SyncThru Web Service

You can store fax numbers conveniently from the networked computer using **SyncThru Web Service**.

1. Open the web browser in your computer.
  2. Enter IP address of your machine, then **SyncThru Web Service** shows. (Example. <http://123.123.123.123>)
  3. Press **Machine Settings** > **Fax Setup** > **Fax Phone Book**.
  4. Select **Speed Dial** (Individual).
-  Fax numbers already stored in **Speed Dial (Individual)** can be used when selecting.
5. Press **Add**.
  6. Enter **Index**, **Name** and **Phone Number**. **Index** you enter here will be the **Speed Dial No.** in the display screen of your machine.
  7. Press **Apply**.

 **Speed Dial** numbers can be imported from an \*.csv file.

## USING THE POLLING OPTION

Polling is used when one fax machine requests another to send a document. This is useful when the person with the original document is not in the office. The person who wants to receive the document, calls the machine holding where the original is stored and requests that the document be sent. In other words, it "polls" the machine holding that has the original.

 To use this feature, both the sender and receiver must have the polling feature.

The polling process is as follows:

1. Sender stores the originals in the machine. (See "Storing the originals for polling" on page 66.)
2. Sender gives the **Passcode** to the receiver.
3. Receiver dials the fax number and enters the **Passcode** when requested. (See "Polling a remote fax" on page 66.)

- Receiver presses **Start** to receive the stored fax.

## Storing the originals for polling

- Press **Fax** from the **Main** screen.
- Place the originals face up in the DADF. Or you can use the scanner glass with a single original document, face down.
- Adjust the document settings in the **Image** tab and the **Basic** tab.
- Press the **Advanced** tab > **Polling** > **Store**.

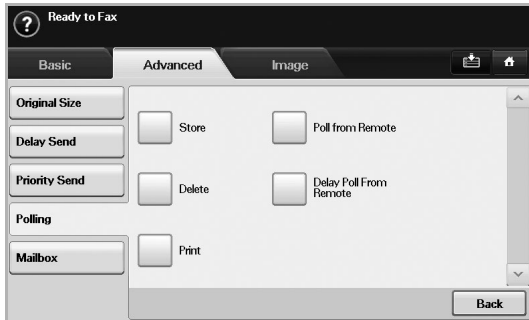

- Press the input area then the pop up keyboard, enter **Passcode** (The four-digit number which you have to inform the receiver). If you do not want to set **Passcode**, enter number 0000 here. Then you can store, delete, print and receive a fax for polling without any passcode.

 If you want to use the **Mailbox**, refer to Storing the originals in the **Mailbox**. (See "Storing originals in Mailbox" on page 67.)

- Select the **Delete On Poll** option. If you select **Off**, the sent fax data will be remained in the machine's memory even after it's printing. If you select **On**, the fax data will be deleted at the printing point.
- Press **OK** to start to store the originals into memory for polling.
- Give the **Passcode** to the receiver.

## Printing (Deleting) the polling document

- Press **Fax** from the **Main** screen.
- Press the **Advanced** tab > **Polling** > **Print** (or **Delete**).
- Enter **Passcode**
- Press **OK**.

## Polling a remote fax

This option allows you to retrieve (poll) a fax which is stored in the remote machine.

- Press **Fax** from the **Main** screen.
- Press the **Advanced** tab > **Polling** > **Poll from Remote**.

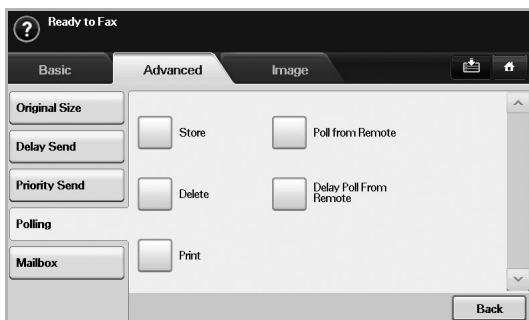

 You can use **Delay Poll From Remote** to poll the fax at a specific time within 24 hours.

- Enter **Passcode** and **Destination Fax No** using the number keypad on the control panel. You have to be informed **Passcode** from sender with the remote fax machine.
- Press **OK**.

## Polling from a remote Mailbox

This option allows you to retrieve (poll) a fax which is stored in the **Mailbox** of on the remote machine. Before you start polling, you must be informed of **Mailbox No.** and **Passcode** from the sender. (See "Using Mailbox" on page 66.)

- Press **Fax** from the **Main** screen.
- Press the **Advanced** tab > **Mailbox** > **Poll from Remote**.

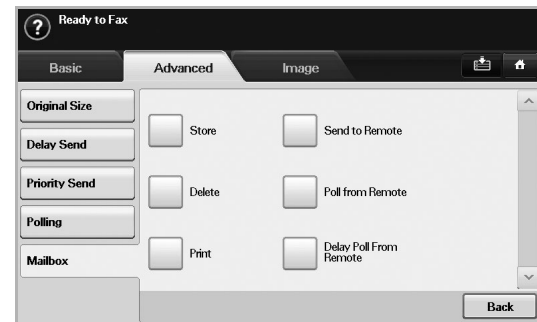

- Enter **Remote Fax No**, **Mailbox No.**, and **Passcode**. All these field are filled with information from the sender.



 You can use **Delay Poll From Remote** to poll a fax from the remote machine's Mailbox at certain time within 24 hours.

- Press **OK**.

## USING MAILBOX

You can store the original data in **Mailbox**, since you are absent and the receiver need to be retrieve a fax from you. This feature allows you to program up to 15 individual Mailbox. Before you store the originals, the Mailbox must be created.

## Creating Mailbox

- Press **Machine Setup** on the control panel.
- Select **Admin Setting**. When the login message pops up, then enter the password and press **OK**.
- Press the **Setup** tab > **Fax Setup**.

4. Press the down arrow to scroll down, if necessary.
5. Press **Mailbox Setup**.
6. Press **Mailbox Configuration**. Then the screen displays **Mailbox List**.
7. Select a **Mailbox** on the **Mailbox List**.

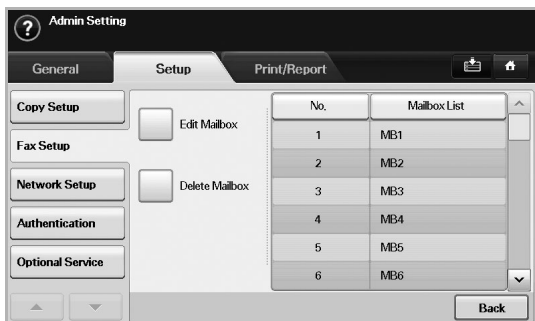

8. Press **Edit Mailbox**.

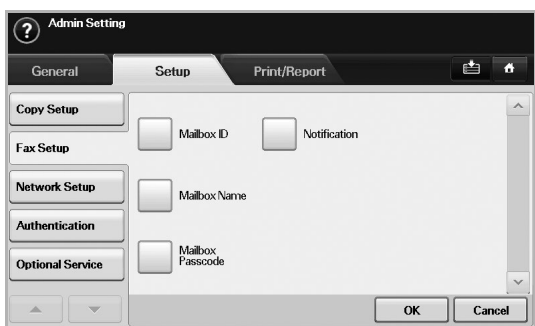

9. Press **Mailbox ID** and enter ID with number keypad on the control panel. Up to 20 numbers you can enter.
10. Enter **Mailbox Name** with the pop up keyboard. It can be either alphabet or number up to 20 digits.
11. Enter **Mailbox Passcode** with the numeric keypad on the control panel.
  -  If you set **Mailbox Passcode** to number 0000, then the machine does not ask passcode for using **Mailbox**, such as storing, deleting, printing, receiving.
12. Set **Notification** option to **On**, if you want to be notified when a fax is received into Mailbox.
13. Press **OK**.

## Storing originals in Mailbox

Since you created the mailbox, you can store originals in it.

1. Press **Fax** from the **Main** screen.
2. Place the originals face up in the DADF. Or you can use the scanner glass with a single original document faced down.
3. Adjust the document settings in the **Image** tab and the **Basic** tab.

4. Press the **Advanced** tab > **Mailbox** > **Store**.

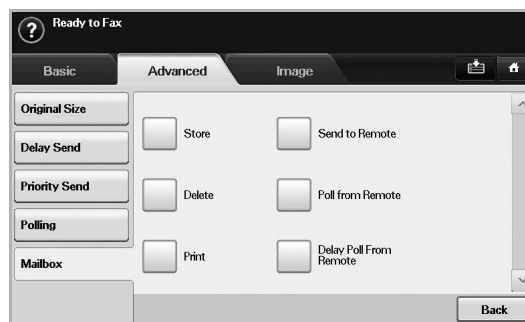

5. Enter **Mailbox No.** and **Passcode** which are set from Creating Mailbox in page 66.

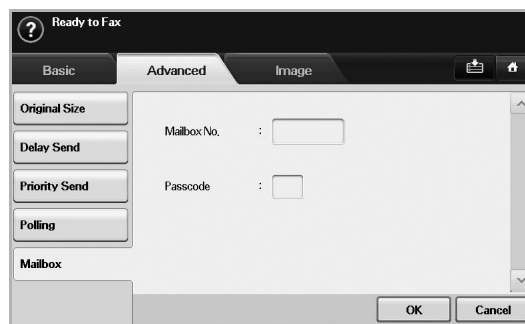

6. Press **OK**.



- **Deleting the data in a specific Mailbox**  
Press **Fax** > the **Advanced** tab > **Mailbox** > **Delete**, enter **Mailbox No.** and **Passcode**, and then press **OK**. When the confirmation window appears, press **Yes** to complete the job.
- **Printing a Mailbox**  
Press **Fax** > the **Advanced** tab > **Mailbox** > **Print**, enter **Mailbox No.** and **Passcode**, and press **OK**.

## Faxing to a remote Mailbox

To fax and store the originals in a recipient's **Mailbox** in this machine, you can use the **Send to Remote** feature.

1. Press **Fax** from the **Main** screen.
2. Place the originals face up in the DADF. Or you can use the scanner glass with a single original document face down.
3. Adjust the document settings in the **Image** tab and the **Basic** tab.
4. Press the **Advanced** tab > **Mailbox** > **Send to Remote**.

5. Enter **Remote Fax No.**, **Mailbox No.**, and **Passcode**. All these field are filled with information from the receiver.

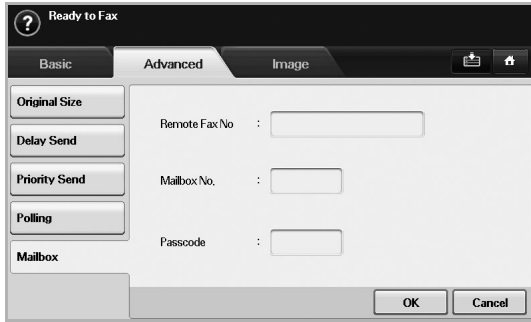

6. Press **OK**.

## PRINTING A REPORT AFTER SENDING A FAX

You can set the machine to print a report whether a fax transmission is successfully completed or not.

 The detailed information is available in advanced setup part. (See "Printing a report" on page 82.)

1. Press **Machine Setup** on the control panel.
2. Press **Admin Setting**. When the login message pops up, enter password and press **OK**. (See "Setting the authentication password" on page 30.)
3. Press the **Print/Report** tab > **Report** > **Fax Report** > **Fax Send Report**.
4. Press **On**.



5. Press **OK**.

## SENDING A FAX IN TOLL SAVE TIME

You can set the machine to send a fax in toll save time to save a telephone fee. If you send a fax after setting this feature, fax data will be stored in machine's memory and the machine will start to send fax in toll save time.

1. Press **Machine Setup** on the control panel.
2. Press **Admin Setting**. When the login message pops up, enter password and press **OK**. (See "Setting the authentication password" on page 30.)
3. Press the **Setup** tab > **Fax Setup**.
4. Press down arrow on the right side.
5. Press **Toll Save**.

6. Press **On**.



7. Press **Start Time** and set the start date and time with left/right arrows.
8. Press **OK**.
9. Press **End Time** and set the end date and time with left/right arrows.
10. Press **OK**.
11. Press **OK**.

## ADDING DOCUMENTS TO A RESERVED DELAY FAX JOB

You can add additional documents to the delayed fax job which is saved in memory.

1. Press **Machine Setup** on the control panel.
2. Press **Admin Setting**. When the login message pops up, enter password and press **OK**. (See "Setting the authentication password" on page 30.)
3. Press the **Setup** tab > **Fax Setup**.
4. Press down arrow on the right side.
5. Press **Send Batch**.
6. Press **On**.
7. Press **OK**.
  - When you send a fax, if a fax number is same as the number in delay fax, the machine asks whether you want to add more documents to reserved delay fax.

## FORWARDING A RECEIVED FAX TO OTHER DESTINATION

You can set the machine to forward the received or sent fax to other destination by a fax or an email. If you are out of office but have to receive the fax, this feature may be useful.

-  When you forward a fax by an email, you firstly set the mail server and IP address in **SyncThru Web Service**.
- If this **Fax Forward Settings** feature to **On**, you cannot use a fax with the **On Hook Dial** button on the control panel.

### Forwarding a sent fax to other destination by a fax

You can set the machine to forward every fax you sent to other destination by faxing.

1. Press **Machine Setup** on the control panel.
2. Press **Admin Setting**. When the login message pops up, enter password and press **OK**. (See "Setting the authentication password" on page 30.)
3. Press the **Setup** tab > **Fax Setup**.

4. Press down arrow on the right side.
5. Press **Fax Forward Settings > Forward to Fax Setting > Send Forward**.
6. Press **On** and enter a fax number using the keypad on the control panel.
7. Press **OK**.

### Forwarding a received fax to other destination by a fax

With this feature, you can forward every fax you received to other destination by faxing. When the machine receives a fax, a fax is stored in the memory then, the machine sends it to the destination you have set.

1. Press **Machine Setup** on the control panel.
2. Press **Admin Setting**. When the login message pops up, enter password and press **OK**. (See "Setting the authentication password" on page 30.)
3. Press the **Setup** tab > **Fax Setup**.
4. Press down arrow on the right side.
5. Press **Fax Forward Settings > Forward to Fax Setting > Receive Forward**.
6. Press **Forward** and enter a fax number using the keypad on the control panel.
  - If you want to set the star time and end time, select **Start Time** and **End Time**.
  - If you want the machine to print the report after forwarding a fax, set the **Forward & Print**.
7. Press **OK**.

### Forwarding a sent fax to other destination by an email

 If **Forward to Server Setting** is on, this option will be grayed out.

1. Press **Machine Setup** on the control panel.
2. Press **Admin Setting**. When the login message pops up, enter password and press **OK**. (See "Setting the authentication password" on page 30.)
3. Press the **Setup** tab > **Fax Setup**.
4. Press down arrow on the right side.
5. Press **Fax Forward Settings > Forward to Email Setting > Send Forward**.
6. Press **On**.
7. Enter the **From** and **Destination Email** option using the keyboard on the display.
8. Press **OK**.

### Forwarding a received fax to other destination by an email

 If **Forward to Server Setting** is on, this option will be grayed out.

1. Press **Machine Setup** on the control panel.
2. Press **Admin Setting**. When the login message pops up, enter password and press **OK**. (See "Setting the authentication password" on page 30.)
3. Press the **Setup** tab > **Fax Setup**.
4. Press down arrow on the right side.
5. Press **Fax Forward Settings > Forward to Email Setting > Receive Forward**.

6. Press **Forward** and enter the **From** and **Destination Email** option using the keyboard on the display.
  - If you want the machine to print the report after forwarding a fax, set the **Forward & Print**.
7. Press **OK**.

### Forwarding a sent fax to other destination by server

 If **Forward to Email Setting** is on, this option will be grayed out. The server setting must be done in **SyncThru Web Service** prior to this option on.

1. Press **Machine Setup** on the control panel.
2. Press **Admin Setting**. When the login message pops up, enter password and press **OK**. (See "Setting the authentication password" on page 30.)
3. Press the **Setup** tab > **Fax Setup**.
4. Press down arrow on the right side.
5. Press **Fax Forward Settings > Forward to Server Setting > Send Forward**.
6. Press **On**.
7. Press **OK**.

### Forwarding a received fax to other destination by server

 If **Forward to Email Setting** is on, this option will be grayed out. The server setting must be done in **SyncThru Web Service** prior to this option on.

1. Press **Machine Setup** on the control panel.
2. Press **Admin Setting**. When the login message pops up, enter password and press **OK**. (See "Setting the authentication password" on page 30.)
3. Press the **Setup** tab > **Fax Setup**.
4. Press down arrow on the right side.
5. Press **Fax Forward Settings > Forward to Server Setting > Receive Forward**.
6. Press **On**.
7. Press **OK**.

## SETTING UP THE END FAX TONE

The end fax tone that sounds to indicate that the fax has been received can be turned on or off.

1. Press **Machine Setup** on the control panel.
2. Press **Admin Setting**. When the login message pops up, enter password and press **OK**. (See "Setting the authentication password" on page 30.)
3. Press the **Setup** tab > **Fax Setup**.
4. Press down arrow on the right side.
5. Press **Fax Ending Sound**.
6. Press **On**.
7. Press **OK**.



# using USB memory device

This chapter explains how to use a USB memory device with your machine.

## This chapter includes:

- About USB memory
- Understanding the USB screen
- Plugging in a USB memory device
- Scanning to an USB memory device

## ABOUT USB MEMORY

USB memory devices are available with a variety of memory capacities to give you more room for storing documents, presentations, downloaded music and videos, high resolution photographs, or whatever other files you want to store or move.

You can do the following on your machine using a USB memory device:

- Scan documents and save them on a USB memory device.
- Print data stored on a USB memory device.
- Format the USB memory device.

## UNDERSTANDING THE USB SCREEN

To use the USB feature, press **USB** on the **Main** screen. If the screen displays an other menu, press (  ) to go to the **Main** screen.

 When an USB memory is inserted into the USB memory port on your machine, USB icon shows on the display screen.

Press **USB Format**, **USB Print** or **Scan to USB**.

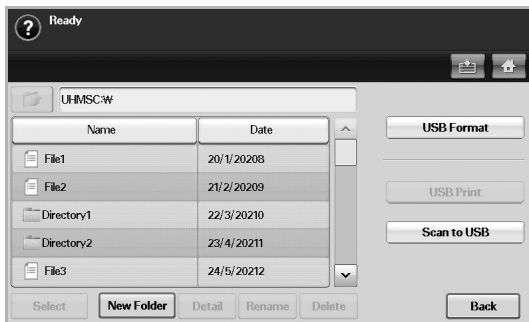

- **USB Format:** You can delete image files stored on an USB memory device one by one or all at once by reformatting the device.
- **USB Print:** You can directly print files stored on an USB memory device. You can print TIFF, BMP, JPEG, PDF, and PRN files. (See "Printing from a USB memory device" on page 74.)
- **Scan to USB:** You can specify image size, file format, or color mode for each scanning to USB job. (See "Scan to USB" on page 71. )

## PLUGGING IN A USB MEMORY DEVICE

The USB memory port on the left side of your machine is designed for USB V1.1 and USB V2.0 memory devices. Your machine supports USB memory devices with FAT16/FAT32 and sector size of 512 bytes.

Check your USB memory device's file system from your dealer.

- Scan to USB
- Changing the scan feature settings
- Printing from a USB memory device

You must use only an authorized USB memory device with an A plug type connector.

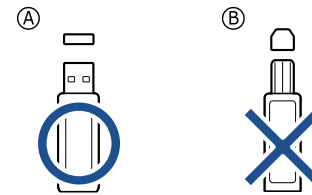

Use only a metal-shielded USB memory device.

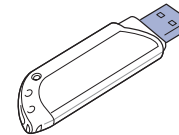

Insert a USB memory device into the USB memory port on the left side of your machine.

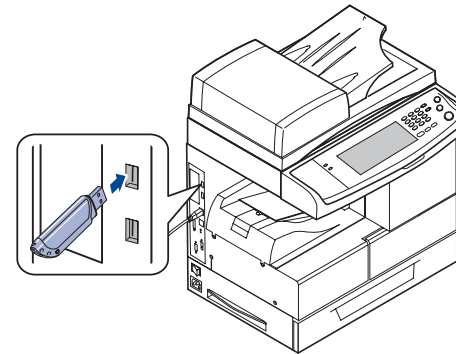

-  Do not remove the USB memory device while the machine is in operation, or writing to or reading from USB memory. The machine warranty does not cover damage caused by use's misuse.
- If your USB memory device has certain features, such as security settings and password settings, your machine may not automatically detect it. For details about these features, see device's User's Guide.



## SCANNING TO AN USB MEMORY DEVICE

You can scan a document and save the scanned image onto a USB memory device. When you scan a document, the machine uses the default settings such as the resolution. You can also customize your own scan setting. (See "Changing the scan feature settings" on page 72.)

### Scanning

1. Insert a USB memory device into the USB memory port on your machine.
2. Place the originals face up in the DADF. Or you can use the scanner glass with a single original document, face down.
3. Press **USB** from the **Main** screen.
4. Press **Scan to USB**.
5. Set the scan features in the **Advanced**, **Image**, or **Output** tabs. (See "Changing the scan feature settings" on page 72.)
6. Press **Start** on the control panel to begin scanning.
7. After scanning is complete, you can remove the USB memory device from the machine.

## SCAN TO USB

### Basic tab

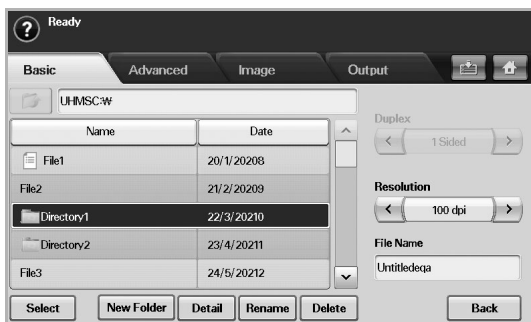

- **Name:** The folder names on the USB memory device.
- **Date:** The date which folders are made.
- **Select:** Selects the folder which has been chosen from the Name.
- **New Folder:** Makes a new folder on the USB memory device.
- **Detail:** Views the details of currently selected folder or file.
- **Rename:** Renames the folder or file name.
- **Delete:** Deletes the folder on the USB memory device.
- **Duplex:** Selects whether the machine scans on one side of the paper (**1 Sided**), both sides of the paper (**2 Sided**), or both sides of paper but back is rotated 180 degrees (**2 Sided, Rotate Side 2**).
- **Resolution:** Selects the scanning resolution value.
- **File Name:** Names a file before you scan a document by just clicking this field.
- **Back:** Returns to the previous screen.

### Advanced tab



- **Original Size:** Sets the originals to a specific fixed size. (See "Original Size" on page 72.)
- **Back:** Returns to the previous screen.

### Image tab

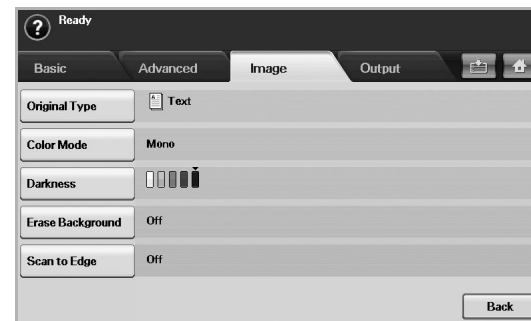

- **Original Type:** Selects whether the original is text or photo. (See "Original Type" on page 72.)
- **Color Mode:** Adjusts the color options of the scan output. If the original is color and you want to scan in color, press **Color Mode**. (See "Color Mode" on page 72.)
- **Darkness:** Adjusts the degree of darkness of the scan output. Use left/right arrow to adjust the values. (See "Darkness" on page 73.)
- **Erase Background:** Erases backgrounds like paper patterns. (See "Erase Background" on page 73.)
- **Scan to Edge:** Scans originals from edge-to-edge. (See "Scan to Edge" on page 73.)
- **Back:** Returns to the previous screen.

### Output tab

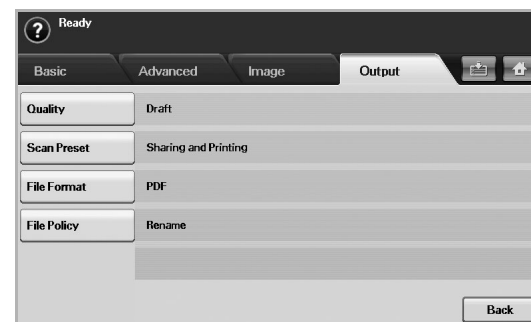

- **Quality:** Adjusts the display quality of the scan output. (See "Quality" on page 73.)

- **Scan Preset:** Automatically changes some scan options such as file format, resolution, and more. You can adjust options to fit each specific purpose. (See "Scan Preset" on page 73.)
- **File Format:** Selects the file format of the scan output. (See "File Format" on page 73.)
- **File Policy:** Selects the file format of the scan output. (See "File Policy" on page 73.)
- **Back:** Returns to the previous screen.

## CHANGING THE SCAN FEATURE SETTINGS

This part explains how to adjust the document settings for each scan job, such as resolution, duplex, original size, type, color mode, darkness, and more. The options you change will be maintained for a certain time, but after that period, the options will be reset to default values.

### Duplex

This feature especially applies when the original documents to be scanned are two-sided. You can select whether the machine scans only one side of the paper or both sides of the paper.

Press **USB > Scan to USB > the Basic tab > Duplex**. Use left/right arrows to toggle the values.



- **1 Sided:** For originals that are printed on one side only.
- **2 Sided:** For originals that are printed on both sides.
- **2 Sided, Rotate Side 2:** For originals that are printed on both sides. But the back is rotated 180 degrees.

 To use **2 Sided** and **2 Sided, Rotate Side 2**, you have to load the originals on the DADF. Because, if the machine can not detect the original on DADF, automatically changes the option to **1 Sided**.

### Resolution

You can adjust document resolution.

Press **USB > Scan to USB > the Basic tab > Resolution**. Use left/right arrows to toggle the values. The higher value you select the clear result you get. But the scanning time may take longer.

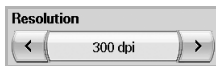

### Original Size

The machine senses and determines the size of the original.

Press **USB > Scan to USB > the Advanced tab > Original Size**. Use up/down arrows to go to the next screen. Select the appropriate option and press **OK**.

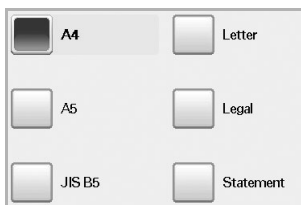

### Original Type

You can set the original document type in order to enhance the quality of a document being scanned.

Press **USB > Scan to USB > the Image tab > Original Type**. Select the appropriate option and press **OK**.



- **Text:** For originals that have text or line art.
- **Text/Photo:** For originals that have both text and photographs together.
- **Photo:** For originals that are continuous tone photographs.

### Color Mode

Use this option to scan the original in **Mono**, **Gray** or **Color** mode.

Press **USB > Scan to USB > the Image tab > Color Mode**. Select the appropriate option and press **OK**.



- **Color:** Uses color to display an image. 24 bits per pixel, 8 bits for each RGB, is used for 1 pixel.
- **Gray:** Uses the black gradation to display an image. 8 bits per pixel.



- **Mono:** Displays an image in black and white. 1 bit per pixel.



 The file format JPEG cannot be selected if **Mono** has been selected for **Color Mode**.

## Darkness

You can select the degree of darkness of the scanned output. If your original document is light or faded, press the right arrow to make the output darker.

Press **USB > Scan to USB > the Image tab > Darkness**. Press right arrow to enhance the darkness degree then, press **OK**.



## Erase Background

You can lighten, reduce or delete the dark background from scanning colored paper or newspaper originals.

Press **USB > Scan to USB > the Image tab > Erase Background**. Select the appropriate option and press **OK**.

- **Off**: Disables this feature.
- **Auto**: Optimizes the background.
- **Enhance**: The higher the number is, the more vivid the background is.
- **Erase**: The higher the number is, the lighter the background is.

## Scan to Edge

You can set the machine to scan full size of a page as it is. Usually, the machine scans a page except edges, which means the margin, especially when you do the copy job with certain sized paper in the tray. But if you scan and sent it right away via the network, as the file, the machine does not need to exclude the edges from the originals.

Press **USB > Scan to USB > the Image tab > Scan to Edge**. Select **On** and press **OK**.

## Quality

You can use this option to produce a high quality document. Higher quality you select a larger file size you get.

Press **USB > Scan to USB > the Output tab > Quality**.



 When you set **Color Mode** to **Mono**, the **Quality** option is grayed out.

## Scan Preset

This feature allows you to use optimized settings for your specific scan job.

Press **USB > Scan to USB > the Output tab > Scan Preset**.

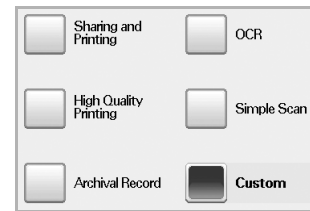

- **Sharing and Printing**: Produces a small-sized file for normal quality documents.
- **High Quality Printing**: Set this option for high quality output with the largest file size.
- **Archival Record**: For the electronic file which is of the smallest file size of the output.
- **OCR**: Produces scanned output for OCR software. You can expect the highest quality images.
- **Simple Scan**: Used for a simple document with text only. The file size of output is small.
- **Custom**: Applies the current scan settings that you have chosen.

## File Format

You can select the file format before you proceed with the scanning job.

Press **USB > Scan to USB > the Output tab > File Format**.

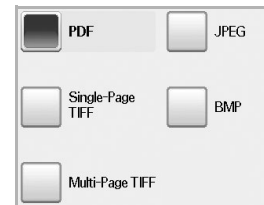

- **PDF**: Scans originals in PDF format.
- **Single-Page TIFF**: Scans originals in TIFF (Tagged Image File Format), but several originals are scanned as one file.
- **Multi-Page TIFF**: Scans the originals in TIFF (Tagged Image File Format), and several originals are scanned as several file.
- **JPEG**: Scans original in JPEG format.
- **BMP**: Scans original in BMP format.

 The file format **JPEG** cannot be selected if **Mono** has been selected for **Color Mode**.

## File Policy

You can choose the policy for generating file name before you proceed with the scan job through USB. If the USB memory already has the same name when you entered a new file name, you can rename or overwrite it.

Press **USB > Scan to USB > the Output tab > File Policy**.



- **Rename**: If the USB memory already has the same name when you entered a new file name, the file will be saved as a different name that is automatically programmed.

- **Overwrite:** You can set the machine to delete previous job information on USB as you store new job information.

## PRINTING FROM A USB MEMORY DEVICE

---

You can directly print files stored on a USB memory device. You can print TIFF, BMP, JPEG, and PRN files.

Direct Print option supported file types:

- PRN: Only files created by provided driver with your machine are compatible.
- PRN files can be created by selecting the Print to file check box when you print a document. The document will be saved as a PRN file, rather than printed on paper. Only PRN files created in this fashion can be printed directly from USB memory. See *Software section* to learn how to create a PRN file.
- BMP: BMP Uncompressed
- TIFF: TIFF 6.0 Baseline
- JPEG: JPEG Baseline
- PDF: PDF 1.4 and below

### To print a document from a USB memory device:

1. Insert a USB memory device into the USB memory port on your machine.  
Your machine automatically detects the device and reads data stored on it.
2. Press **USB** from the **Main** screen.
3. Use up/down arrows until the file you want appears. Select the file name.  
If there is a folder, select folder name and press **Select**.
4. Press **USB Print**.
5. Press **Start** on the control panel.

# machine status and advanced setup

This chapter explains how to browse the current status of your machine, and the method of setting for the advanced machine setup. Please read this chapter carefully in order to use your machine's diverse features.

## This chapter includes:

- Machine Setup
- Browsing the machine's status
- General settings
- Copy Setup
- Fax Setup

- Network Setup
- Authentication
- Optional Service
- Printing a report

## MACHINE SETUP

1. Press **Machine Setup** on the control panel.
2. Select the appropriate item for your occasion.

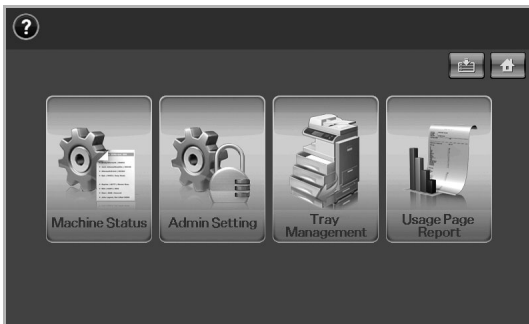

- **Machine Status:** Shows the current machine status.
- **Admin Setting:** Allows administrator to set up the machine. When you press **Admin Setting**, login message pops up. Enter password and press **OK**. (Factory setting is 1111.)
- **Tray Management:** Shows the currently installed tray and their status. You can also change the paper settings for each tray.
- **Usage Page Report:** You can print the report on the amount of printouts depending on the paper size and type.

## Machine Status screen

Press **Machine Setup** on the control panel and press **Machine Status**.

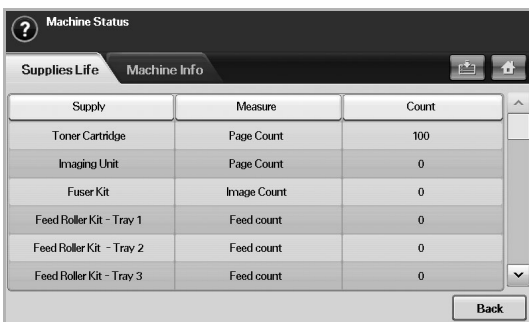

Supply	Measure	Count
Toner Cartridge	Page Count	100
Imaging Unit	Page Count	0
Fuser Kit	Image Count	0
Feed Roller Kit - Tray 1	Feed count	0
Feed Roller Kit - Tray 2	Feed count	0
Feed Roller Kit - Tray 3	Feed count	0

- **Supplies Life** tab: Displays the remainders or the usage count of the machine supplies. Use up/down arrows to switch screens.
- **Machine Info** tab: Displays the detailed information about the machine, and some options allows for validating your machine. (See "Browsing the machine's status" on page 76.)

- **Back:** Returns to the previous screen.

## Admin Setting screen

Gives you access to detailed machine settings.

- When you press **Admin Setting**, a login message appears. If the administrator set the password, you have to enter the password every time you want to use **Admin Setting**. (See "Setting the authentication password" on page 30.)

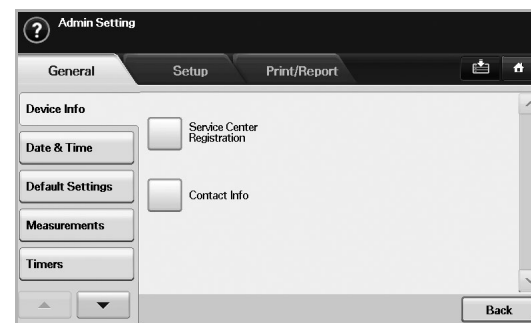

- **General** tab: Sets the basic parameters of the machine such as location, date, time, and more. (See "General settings" on page 76.)
- **Setup** tab: Sets the values for fax, network and login. Also you can set to enable the feature listed on the screen.
- **Print/Report** tab: Prints configuration or font list and displays a report of machine features. (See "Printing a report" on page 82.)
- **Back:** Returns to the previous screen.

## BROWSING THE MACHINE'S STATUS

You can browse the machine information and validate some features of the machine.

1. Press **Machine Setup** on the control panel.
2. Press **Machine Status** > the **Machine Info** tab.

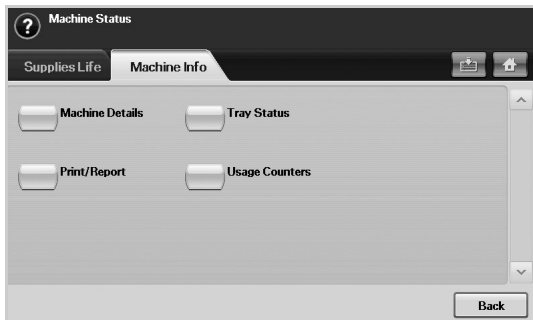



OPTION	DESCRIPTION
<b>Machine Details</b>	This option shows the customer support information on the email address and the phone number you stored from <b>Admin Setting</b> . Also, you can check the machine's serial number, or the hardware and software information specification.
<b>Print/Report</b>	You can print various helpful and informative reports such as <b>System Report</b> , <b>Fax Report</b> and <b>Scan Report</b> . (See "Printing a machine report" on page 83.)
<b>Tray Status</b>	The screen shows the trays installed on your machine, and their current configurations. Select the tray and Edit to change the settings for paper type and size.
<b>Usage Counters</b>	You can view the amount of each category that your machine has printed so far. To print this report, See "Printing a report" on page 82..

## GENERAL SETTINGS

Before you get ready to using the machine, it is recommended to set up the machine parameters.

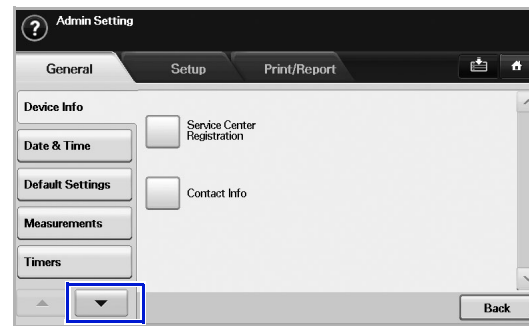
1. Press **Machine Setup** on the control panel.
2. Press **Admin Setting**. When the login message pops up, then enter password and press **OK**. (Factory setting is 1111.)
3. Press the **General** tab.



OPTION	DESCRIPTION
<b>Device Info</b>	The sub-options available are <b>Service Center Registration</b> and <b>Contact Info</b> . You may enter information on service center and purchasing point.
<b>Date &amp; Time</b>	You can set the date and time. (See "Setting the date and time" on page 30.)
<b>Default Settings</b>	<ul style="list-style-type: none"> <li>• <b>Default Window:</b> Set the first window that will appear on the display screen after turning on the machine or waking up from the <b>Power Save</b>. For example, if you select <b>Fax</b> as a default window, the first window will be the <b>Basic</b> tab of the <b>Fax</b> feature. In case you want to show <b>ID Copy</b> as a default window, you need to enable this feature in <b>Default Option</b> previously.</li> <li>• <b>Default Option:</b> Changes all the default values for copying, faxing, emailing, scanning and paper at once. (See "Changing the default settings" on page 31.)</li> <li>• <b>Home:</b> Changes the order of windows that will appears on the display screen.</li> </ul> <p> Depending on the optional kit you installed or the category you selected, the selectable options on the display screen may differ.</p>
<b>Measurements</b>	This option lets you change the measurement unit to use (mm or inch), and set the numeric separation (comma or period).
<b>Timers</b>	The machine cancels a printing job if data does not be received in specific time. <ul style="list-style-type: none"> <li>• <b>System Timeout:</b> The machine returns to the default value after certain time the machine waits. You can set a time for maximum 10 minutes.</li> <li>• <b>Held Job Timeout:</b> The machine holds a job for a specific time period. You can set a time period for at least an hour.</li> </ul>
<b>Language</b>	It allows you to change the language that appears on the touch screen.



OPTION	DESCRIPTION
<b>Power Saver</b>	You can reduce energy consumption by setting these features. <b>Power Saver</b> has three options, first <b>Scan Power Save</b> turns off the scanner lamp under the glass. And <b>Power Save</b> turns off all the fans within the machine after a certain time. <b>Low Power Save</b> turns off the fans within the machine except a core fan for the fuser unit. (See "Using energy saving feature" on page 30.)
<b>Tray Management</b>	This feature allows you to select the tray and paper you use for a printing job. Paper size, paper type, and paper color options are adjusted here. <b>Tray Confirmation Message</b> is to activate the window asking whether you set the paper size and type for the just opened tray. <ul style="list-style-type: none"> <li>• <b>Auto Tray Switch:</b> If tray1 and tray2 are filled with letter size paper, when tray1 is empty and this option is <b>On</b>, then the machine continues printing with paper in tray2.</li> <li>• <b>Auto Continue:</b> When the paper is mismatched, meaning that tray1 has filled with the letter size paper, but the printing job needs A4 size paper, the machine will wait for 30 seconds to paper in tray1 with proper sized paper. After 30 seconds, the machine automatically starts printing with Letter sized paper.</li> <li>• <b>Paper Substitution:</b> When the paper is mismatched, this option sets the machine print A4 size paper in the Letter size paper or vice versa.</li> <li>• <b>Wide A4:</b> It is useful when printing in DOS mode. This option prints 80 characters in a line, which printing 78 characters in a line is usual in DOS mode.</li> </ul>
<b>Altitude Adjustment</b>	Print quality is affected by atmospheric pressure, which atmospheric pressure is determined by the height of the machine above sea level. This feature lets you adjust the altitude in a height district. Higher altitude location need to set this feature to <b>High 3</b> , which affects print quality.
<b>Output Options</b>	<b>Output Options</b> is for, when the staples run out, you to let the machine stop processing and wait to refill the staples or continue the job. If you set <b>Within Job Offsetting</b> to <b>On</b> , the output paper is placed and sorted by printout-sets.
<b>Contention Management</b>	This feature lets you to select the priority between copy jobs and print jobs. <ul style="list-style-type: none"> <li>• <b>Priority:</b> Set the priority by numbering the job. The machine starts from the least to the highest number in order.</li> <li>• <b>First In, First Out:</b> The machine does an asked job in order.</li> </ul>
<b>Sound</b>	You can adjust the loudness of the machine sound. Press <b>Fault</b> to adjust the machine's error sound. Select <b>Conflict</b> if you pressed the wrong option. Press <b>Selection</b> to sound whenever you press the selection from your touch screen.

OPTION	DESCRIPTION
<b>Supplies Management</b>	The machine gives you the notification of the imaging unit and toner cartridge to reorder, and resets the used fuser counter, bias transfer roller, feed roller and document feeder friction pad counter.
<b>Machine Test</b>	The machine prints the test image patterns using <b>Image Quality Test Patterns</b> .
<b>HDD Spooling</b>	To spool documents in HDD for the network printing, select <b>On</b> .
<b>On Demand Overwrite</b>	You can set the machine to delete previous job information on HDD as you store new job information. To activate this feature, go to <b>Admin Setting &gt; the Setup tab &gt; Optional Service</b> and set the <b>On Demand Image Overwrite</b> option to <b>Enable</b> . After activating this feature you can overwrite a HDD by pressing <b>Start</b> in the display.
<b>Stored Job File Policy</b>	You can choose the file policy for generating file name before you proceed with the job through HDD. If the HDD memory already has the same name when you entered a new file name, you can rename or overwrite it. <ul style="list-style-type: none"> <li>• <b>Rename:</b> If the HDD memory already has the same name when you enter a new file name, the file will be saved as a different name that is automatically programmed.</li> <li>• <b>Overwrite:</b> You can set the machine to delete previous job information on HDD as you store new job information.</li> </ul>
<b>Country</b>	You can change the country, then some the values for fax and paper size will be changed automatically for your country. After installing the fax kit, you must change the country.
<b>Home Window Background</b>	You can change the touch screen's background image.
<b>Multi-Bin</b>	You can choose the output mode for printouts. <ul style="list-style-type: none"> <li>• <b>Mailbox:</b> Printouts are stacked in the bin you have set. If you set the mailbox to Bin3, printouts will be stacked in Bin3.</li> <li>• <b>Job Separator:</b> Printouts are stacked in the sequence of job order in each bin. However, if there is a vacant bin left, the vacant bin has priority, which means printouts will be stacked there first.</li> <li>• <b>Collator:</b> Printouts are stacked in sets to match the sequence of originals in each bin.</li> <li>• <b>Stacker:</b> Printouts are stacked in bins one-by-one. When Bin1 is full, printouts will be stacked in Bin2.</li> </ul>  You can only use this feature if you have installed optional 2-Bin Finisher or 4-Bin Mailbox.

## COPY SETUP

For copy output, you can set up several options in advance.

1. Press **Machine Setup** on the control panel.
2. Press **Admin Setting**. When the login message pops up, enter password and press **OK**.
3. Press the **Setup** tab > **Copy Setup**.



OPTION	DESCRIPTION
<b>Page Number</b>	If you select this option <b>On</b> , each copy will include the page number on the bottom of each page.
<b>Time &amp; Date</b>	Set this option <b>On</b> in order to print the date and time on each copy, set from the <b>General</b> tab.
<b>ID Stamp</b>	This option is used to set words or a message to print on your copies. Set this option <b>On</b> and an input screen will be displayed, write your message using the pop up keyboard.
<b>Manual ID Copy Setup</b>	This option sets the ID copy settings such as the number of images or copying positions manually. (See "Copying ID with the manual ID copy option" on page 45.)

## FAX SETUP

This machine offers you with various options to you for setting up the fax system. You can change the default settings for your preferences and needs.

1. Press **Machine Setup** on the control panel.
2. Press **Admin Setting**. When the login message pops up, enter password and press **OK**.
3. Press the **Setup** tab > **Fax Setup**.



 The fax options are different from country to country depending on the international communication regulatory. If the display screen does not show or gray out some of the fax options explained herein, it means that the grayed out function does not supported in your communication environment.

OPTION	DESCRIPTION
<b>Machine ID &amp; Fax No</b>	Enter the machine ID and fax number which will be printed at the top of each page. Select the country name. This option usually pre-set for user.
<b>Receive Start Code</b>	This feature works best when you are using an extension telephone connected to the EXT socket on the back of your machine. You can receive a fax from someone you are talking to on the extension telephone, without going to the fax machine. (See "Receiving faxes manually using an extension telephone" on page 63.)
<b>Error Correction Mode</b>	It helps with poor line quality and makes sure any faxes you send are properly transmitted to any other ECM-equipped fax machines. Sending a fax using ECM may take more time.
<b>Fax Initial Setup</b>	You can set <b>Receive Mode</b> for <b>Telephone</b> , <b>Fax</b> or <b>Answering Machine/Fax</b> , and <b>Dial Mode</b> at either <b>Pulse</b> (Dial Pulse) or <b>Tone</b> (Multi Frequency). When you select <b>Answering Machine/Fax</b> , you can receive a fax while the line is being used by the answering machine. (See "Changing the receive modes" on page 63.) Contact your local telephone company for <b>Dial Mode</b> setting information.
<b>Ring to Answer</b>	You can specify the number of times the machine rings before answering an incoming call.
<b>Receive Header</b>	Use this option to automatically print the page number, date and time of fax reception at the bottom of each page.
<b>Secure Receive</b>	You may need to prevent your received faxes from being accessed by unauthorized people. This feature restricts printing of received faxes when the machine is unattended. If you select this option to <b>On</b> , all incoming faxes go into memory. A four-digit <b>Passcode</b> is used when you want to print out received faxes in memory. (See "Receiving in secure receiving mode" on page 63.)
<b>Received Fax Printing</b>	When receiving a fax containing pages longer than the paper loaded in the tray, the machine can reduce the size of the original to fit the size of the paper loaded in the machine. If this feature is set to <b>Off</b> , the machine cannot reduce the original to fit onto one page. The original will be divided and printed in actual size on two or more pages. If you set this option to <b>On</b> and set the discard size to 10mm and the received data is longer than the currently set paper in the tray, the machine minuses the data that would have been on the specified discard segment.

OPTION	DESCRIPTION
<b>Redial</b>	The machine can automatically redial a remote fax machine, if it was busy. You can set the number of redial attempts and an interval between attempts. Selecting 0 for <b>Redial Times</b> means that the machine will not use this feature.
<b>Speaker Volume</b>	This controls the sound when a fax actually starts to transfer data. If this option is <b>On</b> , the machine sounds from a fax starts until a fax finishes. With <b>Comm.</b> the machine sounds only until the communication is succeeded. No sound with <b>Off</b> option.
<b>Prefix Dial</b>	This feature allows you to set a prefix of up to five digits. This number will be dialed before any automatic number is dialed. User may set this to access a PABX <sup>a</sup> (example *9) or area code number (example 02). When sending a fax, there may be a job which has same recipient's number in delay jobs. In this case, the machine can send faxes to the same recipient in a batch.
<b>Junk Fax Setup</b>	The machine does not accept faxes sent from remote stations if their numbers are stored in the memory as junk fax numbers. You can enter a maximum of 10 junk fax numbers. Press <b>Junk Fax Setup</b> and <b>Edit</b> , then, enter the fax number. If you have set <b>Caller ID</b> enabled, you can browse the last received fax numbers and select a fax number from the list.
<b>Ring Volume</b>	This feature adjusts the ring volume. When you select <b>Off</b> , the machine does not ring.
<b>Dial Tone Volume</b>	When you press <b>On Hook Dial</b> to send a fax, you can hear a specific tone. To adjust the tone volume, you can use this feature. Value 1 is the lowest volume. Use left/right arrows to adjust the value.
<b>Mailbox Setup</b>	<ul style="list-style-type: none"> <li>• <b>Document Policy:</b> You can set the document stored in <b>Mailbox</b> to delete or retain documents after. Select <b>Delete On Poll</b> of each option to delete, <b>Delete On Print</b> to remain the data.</li> <li>• <b>Mail Configuration:</b> You can create, edit, or delete <b>Mailbox</b>. Enter <b>Mailbox ID</b>, <b>Mailbox Name</b>, <b>Mailbox Passcode</b> by pressing options. (See "Using Mailbox" on page 66.)</li> </ul> <p> If you set the <b>Notification</b> option to <b>On</b>, you are notified when a fax is received in <b>Mailbox</b>. (See "Creating Mailbox" on page 66.)</p>
<b>Output Tray</b>	This feature lets you select the paper tray to use for receiving a fax.
<b>Toll Save</b>	Set the machine to send a fax in the toll save time for saving. (See "Sending a fax in toll save time" on page 68.)
<b>Send Batch</b>	The machine asks you whether you want to add the documents to the reserved delay fax, if the fax number you have dialed is same as the delay fax number. (See "Adding documents to a reserved delay fax job" on page 68.)

OPTION	DESCRIPTION
<b>Fax Forward Settings</b>	You can forward a sent or received fax to other destination by a fax or an email. (See "Forwarding a received fax to other destination" on page 68.)
<b>Fax Ending Sound</b>	This setting selects whether the end fax tone is on or off. Set whether you turn on or off the sound of an end of fax receiving. (See "Setting up the end Fax tone" on page 69.)
<b>Caller ID</b>	If you have set this option, the machine remembers the last twenty fax numbers.

a. Private Automatic Branch Exchange

## NETWORK SETUP

You may set up the network with the machine's touch screen. Before doing that, you must have the information concerning the type of network protocols and computer system you use. If you are not sure which setting to use, contact your network administrator to configure this machine network.

1. Press **Machine Setup** on the control panel.
2. Press **Admin Setting**. When the login message pops up, enter password and press **OK**.
3. Press the **Setup** tab > **Network Setup**.

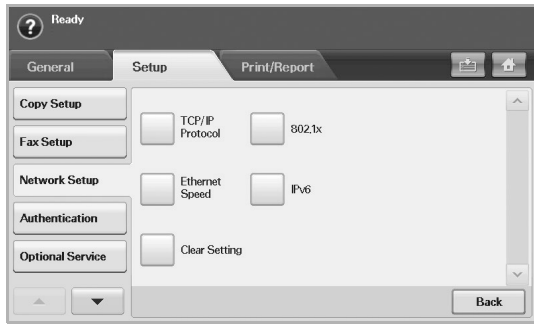

OPTION	DESCRIPTION
<b>TCP/IP Protocol</b>	Select appropriate protocol and configure parameters to use the network environment.   There are lots of parameters to be set, therefore, if you are not sure, leave as it is, or consult the network administrator.
<b>Ethernet Speed</b>	Configure the network transmission speed.
<b>Clear Setting</b>	Reverts the network settings to the default values.
<b>802.1x</b>	You can select the user authentication for network communication. For details information consult the network administrator.
<b>IPv6</b>	Selects this option to use the network environment through IPv6.

## AUTHENTICATION

This feature lets you control and lock all outgoing data, or change the password.

1. Press **Machine Setup** on the control panel.
2. Press **Admin Setting**. When the login message pops up, then enter password and press **OK**.
3. Press the **Setup** tab > **Authentication**.

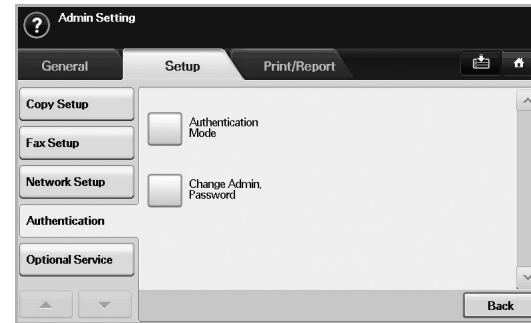

OPTION	OPTION	DESCRIPTION
<b>Authentication Mode</b>	<b>No Authentication Mode</b>	It disables <b>Authentication Mode</b> .
	<b>Network Accounting</b>	It enables the authentication mode which can be used for <b>Job Accounting Plug-in</b> the <b>SyncThru™ Web Admin Service</b> .
	<b>Standard Accounting</b>	You can set the local account for a certain user. If the user with that account performs the printing job, the machine counts it.
	<b>Foreign Device Interface</b>	When you install the optional FDI kit, select <b>Foreign Device Interface Configuration Setup</b> to activate it. <ul style="list-style-type: none"> <li>• <b>Job Timer</b>: If there is not enough credit, you can set the machine to cancel a job right away or wait a designated amount of time for a deposit.</li> <li>• <b>Print Job Control</b>: When it is enabled, the both computer printing and copying are possible since the credit remains. With <b>Disable</b>, only the copy printing job needs the credit. (which means a computer printing a report or a fax job needs no credits)</li> <li>• <b>Inhibit Services</b>: When no credit is left, the machine disables the copy job only with <b>Copy Only</b>. With <b>All Services</b>, scanning service and copy job are disabled.</li> </ul>

OPTION	OPTION	DESCRIPTION
<b>Authentication Mode</b> (Continue)	<b>Foreign Device Interface</b> (Continue)	<ul style="list-style-type: none"> <li>• <b>Internal Credits:</b> It is used when you cancel the job or when the job is cancelled by the device due to insufficient credits (coin) or is canceled by user's request. If you select <b>Enable</b>, the machine deposits a credit equal to the number of sheets that did not print out correctly, then it prints next job for free (for the amount deposited). With <b>Disable</b>, even if you cancel the printing job, the machine includes jammed paper in the count and the cost of printing.</li> <li>• <b>Image Counter:</b> Depends on whether the machine counts blank white pages.</li> </ul>
<b>Change Admin. Password</b>		You can change the password for the <b>Admin Setting</b> authentication.

OPTION	DESCRIPTION
<b>Scan to SMB</b>	Enables or disables the <b>Scan to SMB</b> option from the scan screen.
<b>Scan to FTP</b>	Enables or disables the <b>Scan to FTP</b> option from the scan screen.
<b>On Demand Image Overwrite</b>	You can set the machine to delete previous job information on HDD as you store new job information. Set this option to <b>Enable</b> , go to the <b>General</b> tab > <b>On Demand Overwrite</b> , press <b>Start</b> in the display to start the overwriting job.
<b>Immediate Image Overwrite</b>	If you select <b>Enable</b> , the machine renews the HDD memory when you save new job on it.

## OPTIONAL SERVICE

When you want to add the optional features for this machine, you have to install the optional kit and then set the machine to enable and activate those features. Follow the next steps to enable those features.

1. Press **Machine Setup** on the control panel.
2. Press **Admin Setting**. When the login message pops up, then enter password and press **OK**.
3. Press the **Setup** tab > **Optional Service**.

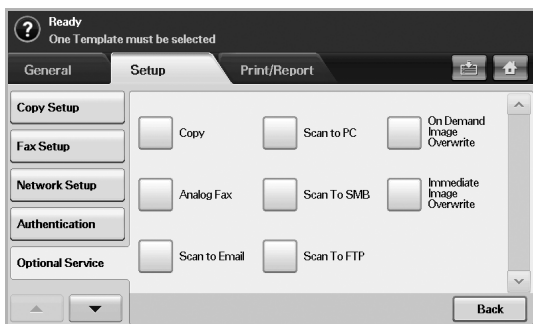

OPTION	DESCRIPTION
<b>Copy</b>	Enables or disables the <b>Copy</b> menu from the main screen.
<b>Analog Fax</b>	After installing the fax kit, select this option <b>Enable</b> to use this machine as a fax machine.
<b>Scan to Email</b>	Enables or disables the <b>Scan to Email</b> menu from the scan screen.
<b>Scan to PC</b>	Set <b>Enable</b> to activate the scanning and sending it via network.



## PRINTING A REPORT

You can print a report on the machine's configuration or font list, etcetera.

1. Press **Machine Setup** on the control panel.
2. Press **Admin Setting**. When the login message pops up, then enter password and press **OK**.
3. Press the **Print/Report** tab.

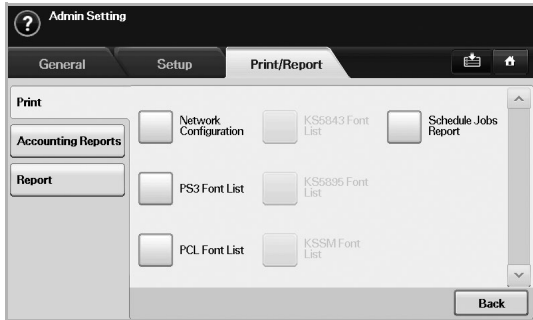

OPTION	OPTION	DESCRIPTION
<b>Print</b>		You can print <b>Network Configuration, PS3 Font List, PCL Font List</b> and <b>Schedule Jobs Report</b> . <b>Schedule Jobs Report</b> shows the job list in pending, in delayed faxing or the Mailbox list as well.
<b>Accounting Reports</b>	<b>Supplies Information</b>	You can print the amount of each category that your machine has printed so far.
	<b>Network Auth. Log Report</b>	It displays user login IDs and emails.
	<b>Usage Page Report</b>	You can print the report on the amount of printouts depending on the paper size and type.
	<b>Accounting Report</b>	Prints the report of printing out count for each login user.
	<b>Standard Acct. Usage Report</b>	Prints the used amount of <b>Standard Accounting</b>
	<b>Standard Acct. Remain Report</b>	Prints the remained amount of <b>Standard Accounting</b>

OPTION	OPTION	DESCRIPTION
<b>Report</b>	<b>Configuration Report</b>	You can print a report on the machine's overall configuration.
	<b>Fax Report</b>	You can set to print the information of a fax reports. <ul style="list-style-type: none"> <li>• <b>Multi Send Report:</b> When you fax to several destination, set this option to print a transmission report. <b>On</b> is to print every time you send a fax, the machine prints a confirmation report. With <b>On-Error</b>, only when the transmission error occurred, the report will be printed out.</li> <li>• <b>Fax Send Report Appearance:</b> You can select whether the image on the confirmation report shows or not.</li> <li>• <b>Fax Sent/Received Report:</b> The machine stores the logs on each transmission and prints out every 50 logs with this option <b>On</b>. If you select <b>Off</b>, the machine stores the logs but does not print.</li> <li>• <b>Fax Send Report:</b> The machine prints the confirmation report after each fax job, only when you send a fax to one destination.</li> </ul>
<b>Report (Continue)</b>	<b>E-mail Confirmation Report</b>	The report shows the job of scanning and sending it via <b>Scan to Email</b> . <ul style="list-style-type: none"> <li>• <b>On:</b> The report is printed whether a job successfully completed or failed.</li> <li>• <b>Off:</b> No report is printed after completing a job.</li> <li>• <b>On-Error:</b> Only in case of error occurrence, the machine prints the report.</li> </ul>
	<b>Scan to Server Confirmation</b>	The report shows the job of scanning and sending it via SMB and FTP. <ul style="list-style-type: none"> <li>• <b>On:</b> The report is printed whether a job successfully completed or failed.</li> <li>• <b>Off:</b> No report is printed after completing a job.</li> <li>• <b>On-Error:</b> Only in case of error occurrence, the machine prints the report.</li> </ul>



You can also print machine's status information and browse status with **SyncThru Web Service**. Open the web browser on your networked computer and type the IP address of your machine. When **SyncThru Web Service** opens, click **Information > Print information**.



# maintenance

This chapter provides information for maintaining your machine and the toner cartridge.

## This chapter includes

- Printing a machine report
- Monitoring the supplies life
- Finding the serial number
- Sending the toner reorder notification
- Sending the imaging unit reorder notification

## PRINTING A MACHINE REPORT

You can print the machine's information and job report.

1. Press **Machine Setup** on the control panel.
2. Press **Machine Status** > the **Machine Info** tab > **Print/Report**.
3. Select the report type, then the right side of the screen shows the list to print.
4. Select the list to print.

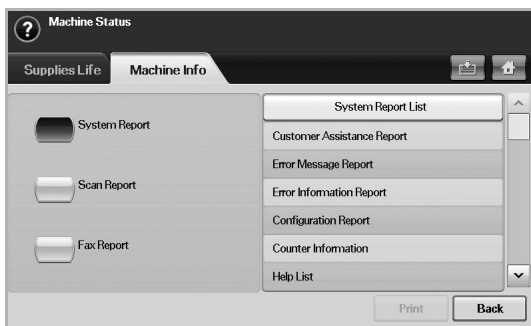

5. Press **Print**.



- If you want to print the machine's network information or font list, press **Machine Setup** > **Admin Setting** > the **Print/Report** tab > **Report**. In case you select the **Configuration Report**, just press **Print Now** to print the report. The **Fax Report**, **E-mail Confirmation Report**, and **Scan to Server Confirmation** options do not provide the print, these are only for report setup.
- You can use **SyncThru Web Service** to print the machine's configuration or browse the status. Open the web browser in the networked computer, and type the machine's IP address. When **SyncThru Web Service** is opened, click **Information** > **Print information**.

## MONITORING THE SUPPLIES LIFE

If you want to view the supply life indicators, follow the next step.

1. Press **Machine Setup** on the control panel.
2. Press **Machine Status**.
3. Scroll down to browse the entire supplies list view the percentage remaining.

- Checking Document Box
- Cleaning your machine
- Maintaining the Toner cartridge
- Maintaining the imaging unit
- Maintenance Parts

## FINDING THE SERIAL NUMBER

If you want to check your serial number from the screen, follow the next steps.

1. Press **Machine Setup** on the control panel.
2. Press **Machine Status** > the **Machine Info** tab > **Machine Details**.

## SENDING THE IMAGING UNIT REORDER NOTIFICATION

You can set the machine to alert you that the life of the imaging unit is almost over and needs to be reordered.

1. Press **Machine Setup** on the control panel.
2. Press **Admin Setting**. When the login message pops up, then enter password and press **OK**.
3. Press the **General** tab > **Supplies Management** > **Imaging Unit Reorder Notification**.
4. Press **Imaging Unit Low Alert** to enable this option not, and press **Imaging Unit Low Alert Level** to set the remained life level.
5. Press **OK**.

## SENDING THE TONER REORDER NOTIFICATION





You can set the machine to alert you that the toner level is low and needs to be reordered.

1. Press **Machine Setup** on the control panel.
2. Press **Admin Setting**. When the login message pops up, then enter password and press **OK**.
3. Press the **General** tab > **Supplies Management** > **Toner Cartridge Reorder Notification**.
4. Press **Toner Low Alert** to enable this option not, and press **Toner Low Alert Level** to set the remained life level.
5. Press **OK**.

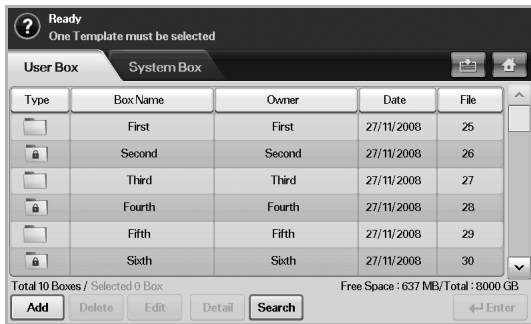
## CHECKING DOCUMENT BOX

The machine shows the document box list of the print or fax job. Press **Document Box** on the **Main** screen. If the screen displays an other menu, press (  ) to go to the **Main** screen.



Type	Box Name	Owner	Date	File
	First	First	27/11/2008	25
	Second	Second	27/11/2008	26
	Third	Third	27/11/2008	27
	Fourth	Fourth	27/11/2008	28
	Fifth	Fifth	27/11/2008	29
	Sixth	Sixth	27/11/2008	30

- **User Box** tab: Create the box where you can save the document such as the file you have printed, sent by email or scanned. When you create a box, you can set the password to secure your box. The box with a password is called **Secured Box**, and without it, it is called public box.
- **System Box** tab: The machine provided default boxes, which you cannot modify them.
- **Type**: Shows the box is secured or not.
- **Box Name**: Shows the box name.
- **Owner**: Shows the user name of a box.
- **Date**: Shows the date of a box created.
- **File**: Shows the number of total files in the box.
- **Add**: Lets you add more boxes.
- **Delete**: Deletes the selected box.
- **Edit**: Lets you to modify a box name and an owner name.
- **Detail**: Shows box information.
- **Search**: Searches a box with a box name or an owner name.
- **Enter**: Prints or sends the stored file in the box.

## CLEANING YOUR MACHINE

To maintain print and scan quality, follow the cleaning procedures below each time the toner cartridge is replaced or if print and scan quality problems occur.

- ⚠ • Cleaning the cabinet of the machine with cleaning materials containing large amounts of alcohol, solvent, or other strong substances can discolor or distort the cabinet.
- If your machine or its surrounding is contaminated with toner, we recommend you to use cloth or tissue dampened with water to clean it. If you use a vacuum cleaner, toner blows in the air and might be harmful to you.

### Cleaning the outside

Clean the machine cabinet with a soft lint-free cloth. You can dampen the cloth slightly with water, but be careful not to let any water drip onto or into the machine.

### Cleaning the inside

Contact a service representative to clean the inside of the machine.

## Cleaning the transfer unit

The cleaning the transfer unit within this machine is recommended for its printing quality. The cleaning period is best once a year or once 10,000 pages printing.

1. Prepare a soft lint-free cloth.
2. Turn off the machine.
3. Unplug the power cable.
4. Open the side cover.

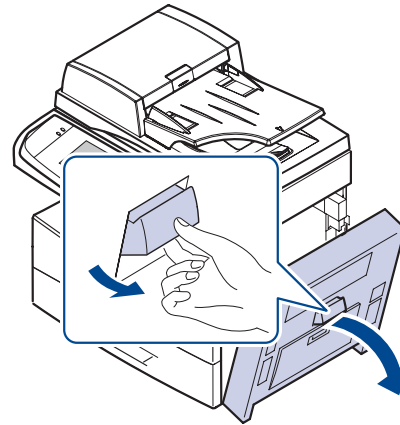

5. Wipe the surface of the transfer unit.

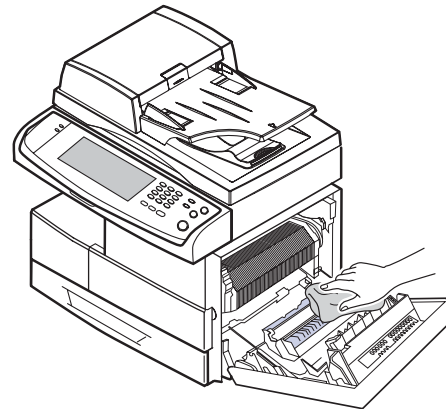

6. Close the side cover.
7. Plug the power cable and turn the machine on.

## Cleaning the scan unit

Keeping the scan unit clean helps ensure the best possible copies. We suggest that you clean the scan unit at the start of each day and during the day, as needed.

1. Slightly dampen a soft lint-free cloth or paper towel with water.
2. Open the scanner lid.

- Wipe the surface of the scanner glass and DADF glass until it is clean and dry.

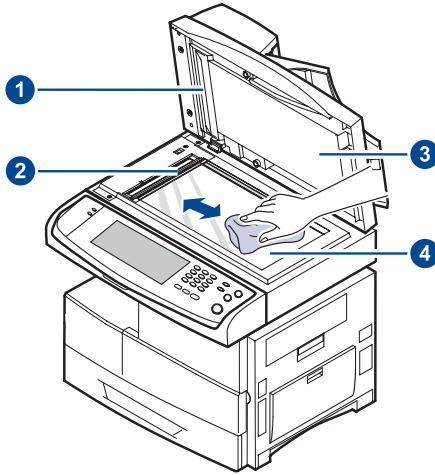

- |   |               |
|---|---------------|
| 1 | white sheet   |
| 2 | DADF glass    |
| 3 | scanner lid   |
| 4 | scanner glass |

- Wipe the underside of the scanner lid and white sheet until it is clean and dry.
- Close the scanner lid.

## MAINTAINING THE TONER CARTRIDGE

### Toner cartridge storage

Toner cartridges contain components that are sensitive to light, temperature, and humidity. Samsung suggests users follow the recommendations to ensure the optimum performance, highest quality, and longest life from your new Samsung toner cartridge.

Store this cartridge in the same environment as the printer it will be used in; this should be in controlled office temperature and humidity conditions. The toner cartridge should remain in its original, unopened package until installation – If original packaging is not available, cover the top opening of the cartridge with paper and store in a dark cabinet.

Opening the cartridge package prior to use dramatically shortens its useful shelf and operating life. Do not store on the floor. If the toner cartridge is removed from the printer, always store the cartridge:

- Inside the protective bag from the original package
- Correct side up in a horizontal position (not standing on end)
- Do not store consumables in;
  - Temperature greater than 40°C (104°F).
  - Humidity range less than 20% and not greater than 80%.
  - An environment with extreme changes in humidity or temperature.
  - Direct sunlight or room light.
  - Dusty places.
  - A car for a long period of time.
  - An environment where corrosive gases are present.
  - An environment with salty air.

### Handling instructions

- Do not touch the surface of the photosensitive drum in the cartridge.
- Do not expose the cartridge to unnecessary vibrations or shock.
- Never manually rotate the drum, especially in the reverse direction; this can cause internal damage and toner spillage.

## Use of non-Samsung and refilled toner cartridge

Samsung Electronics does not recommend or approve the use of non-Samsung brand toner cartridges in your printer including generic, store brand, refilled, or remanufactured toner cartridges.

- ⚠ Samsung's printer warranty does not cover damage to the machine caused by the use of a refilled, remanufactured, or non-Samsung brand toner cartridge.

## Estimated cartridge life

Estimated cartridge life (the life of the toner cartridge yield) depends on the amount of toner that print jobs require. The actual print-out number may vary depending on the print density of the pages you print on, operating environment, printing interval, media type, and/or media size. For example, if you print a lot of graphics, the consumption of the toner is high and you may need to change the cartridge more often.

## Replacing the toner cartridge

When the toner cartridge is completely empty:

- **End of life, Replace with new toner cartridge** appears on the display.
- The machine stops printing. Incoming faxes are saved in memory.

At this stage, the toner cartridge needs to be replaced. Check the type of the toner cartridge for your machine. (See "Supplies" on page 112.)

- Open the side cover.

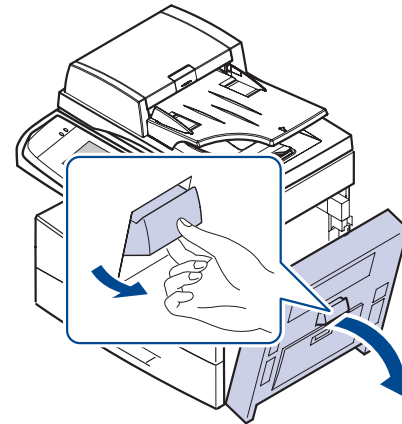

- Open the front cover.

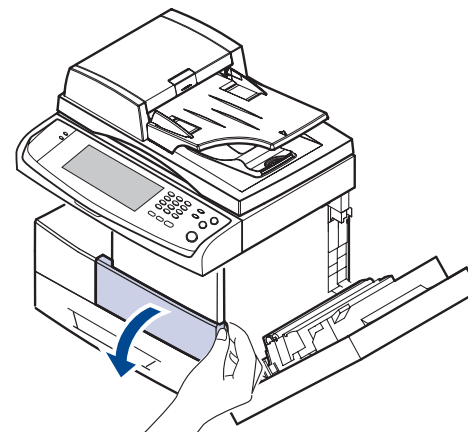

3. Turn the cartridge locking lever toward the right until you hear a 'click', to release the toner cartridge.

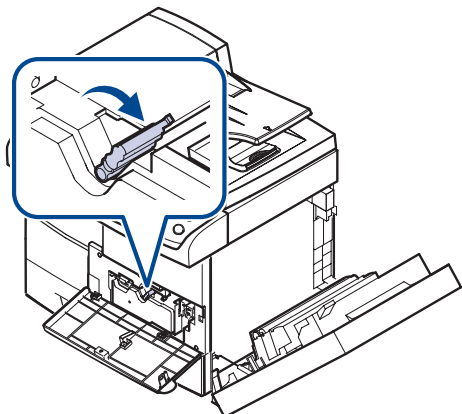

4. Lift the locking lever and pull the toner cartridge out.

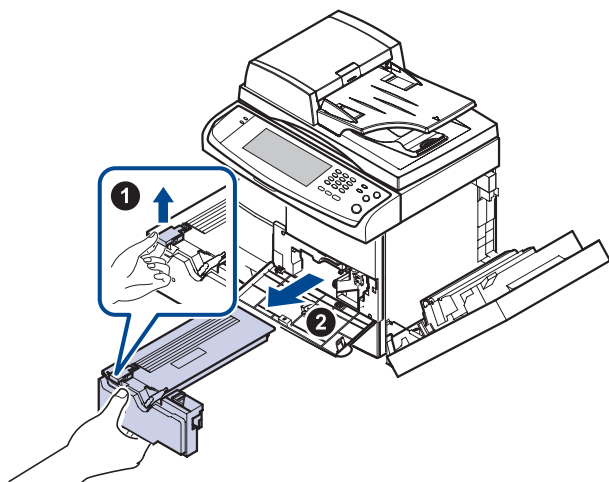

5. Remove the new toner cartridge from its bag.  
6. Thoroughly roll the cartridge five or six times to distribute the toner evenly inside the cartridge.

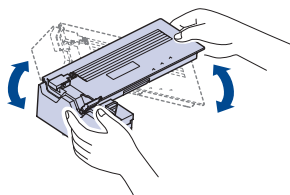

-  If toner gets on your clothing, wipe it off with a dry cloth and wash clothing in cold water. Hot water sets toner into fabric.
7. Hold the toner cartridge by the handle and slowly insert the cartridge into the opening in the machine.

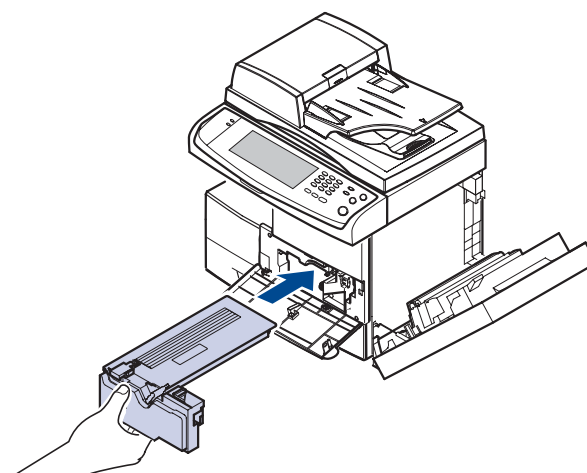

8. Slide the new toner cartridge in until it locks in place.  
9. Turn the cartridge locking lever toward the left until you hear a 'click'.

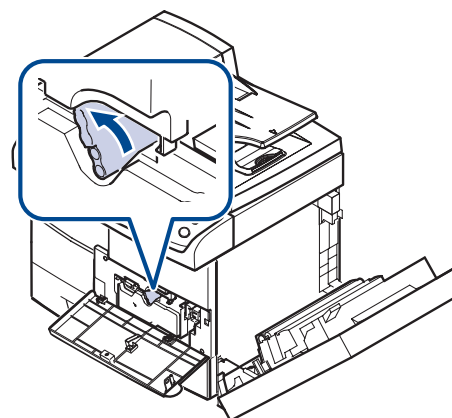

10. Close the front cover, then the side cover.

 After replacing the toner cartridge, wait for several minutes without powering off until the machine enters to standby mode. Otherwise it may cause malfunction of the machine.

## MAINTAINING THE IMAGING UNIT

### Expected cartridge life

The useful life of the imaging unit is approximately 80,000 pages. The screen displays **Replace with new imaging unit** when the life of the imaging unit is almost ended. Approximately 6,000 more pages can be made after the warning message related to the imaging unit, but you should have a replacement imaging unit in stock. Imaging unit yield may be affected by the operating environment, optional, printing interval, media type and media size.

- **Replace with new imaging unit** appears on the display.

For ordering information for imaging unit. (See "Supplies" on page 112.)

 To prevent damage to the imaging unit, do not expose it to light for more than a few minutes.

## Replacing the imaging unit

1. Open the side cover.

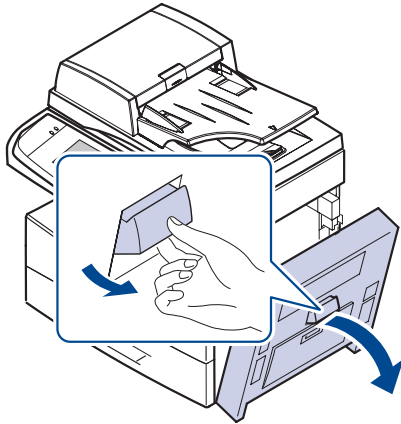

2. Open the front cover.

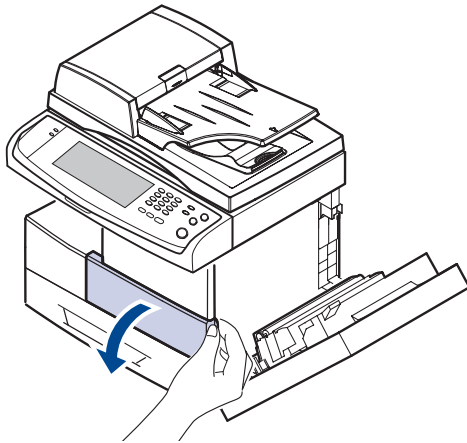

3. Turn the cartridge locking lever toward the right until you hear a 'click', to release the toner cartridge.

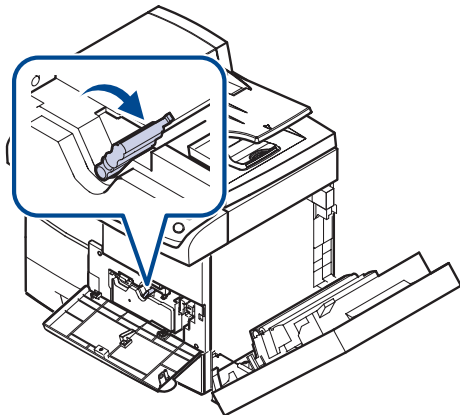

4. Lift the locking lever and pull the toner cartridge out.

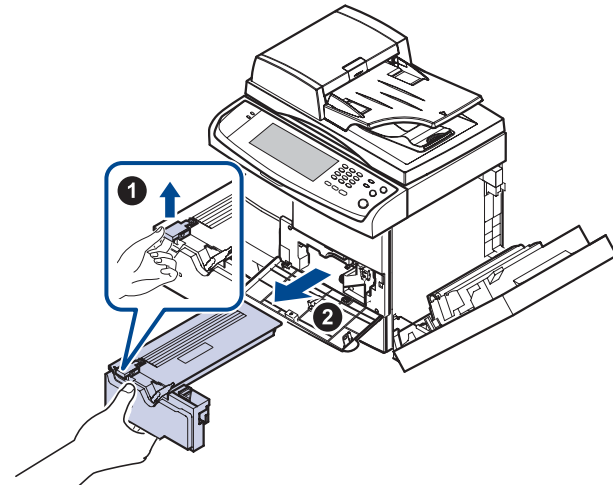

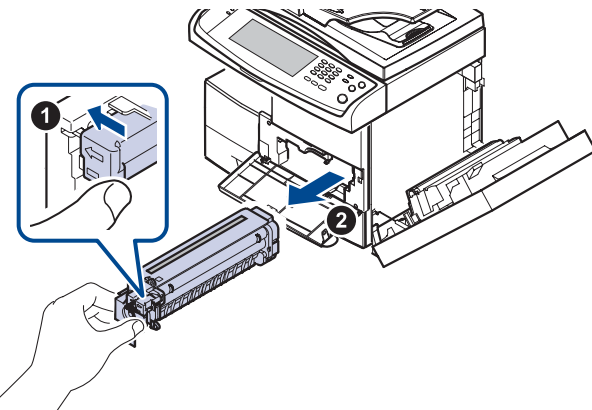

 The toner cartridge must be removed to replace the imaging unit.

5. Pull the used imaging unit out.

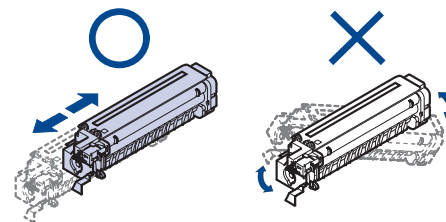

6. Remove the new imaging unit from its bag.
7. Open the carefully pull the seal tape out of the cartridge.
8. Thoroughly shake the imaging unit side to side five or six times.



 If toner gets on your clothing, wipe it off with a dry cloth and wash clothing in cold water. Hot water sets toner into fabric.

 Do not touch the green part, midside of the imaging unit. Use the handle on the cartridge to avoid touching this area.

9. Unpack the new imaging unit and slide it into place, making sure not to touch the surface of the imaging unit.



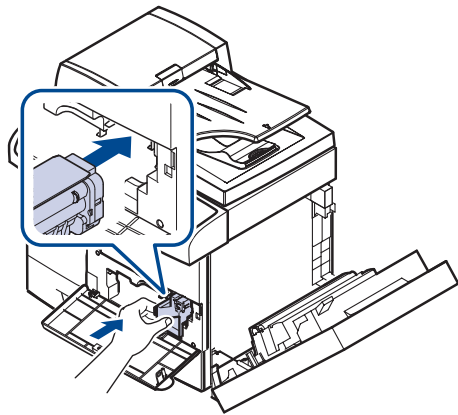

**10.** Slide the toner cartridge in until it locks in place.

**11.** Turn the cartridge locking lever toward the left until you hear a 'click'.

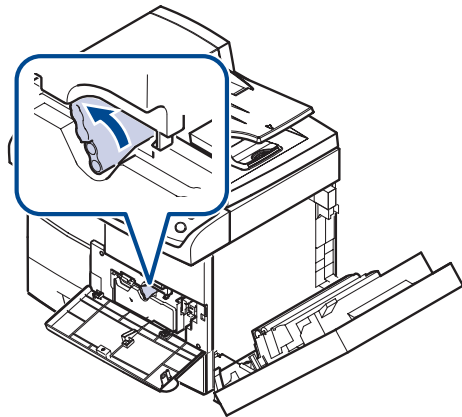

**12.** Close the front cover, then the side cover.

 After replacing the toner cartridge, wait for several minutes without powering off until the machine enters to standby mode. Otherwise it may cause malfunction of the machine.

## MAINTENANCE PARTS

To avoid print quality and paper feed problems resulting from worn parts and to maintain your machine in top working condition the following items will need to be replaced after the specified number of pages or when the life span of each item has expired.

ITEMS	YIELD (AVERAGE)
<b>DADF rubber pad</b>	Approx. 50,000 pages
<b>Multi-purpose tray rubber pad</b>	Approx. 50,000 pages
<b>DADF feed roller</b>	Approx. 250,000 pages
<b>Multi-purpose tray feed roller</b>	Approx. 200,000 pages
<b>Transfer roller</b>	Approx. 125,000 pages
<b>Fuser unit</b>	Approx. 250,000 pages
<b>Paper Feed roller</b>	Approx. 250,000 pages

We highly recommend that this maintenance be performed by an authorized service provider, dealer or the retailer where you bought the machine. The warranty does not cover the replacement of the maintenance parts after their lifespan.



# troubleshooting

This chapter gives helpful information for what to do if you encounter an error.

## This chapter includes:

- Tips for avoiding paper jams
- Clearing document jams
- Clearing paper jams
- Understanding display messages
- Solving other problems

## TIPS FOR AVOIDING PAPER JAMS

By selecting the correct media types, most paper jams can be avoided. When a paper jam occurs, follow the steps outlined on page 89.

- Ensure that the adjustable guides are positioned correctly. (see "Loading paper" on page 38)
- Do not overload the tray. Ensure that the paper level is below the paper capacity mark on the inside of the tray.
- Do not remove paper from the tray while your machine is printing.
- Flex, fan, and straighten paper before loading.
- Do not use creased, damp, or highly curled paper.
- Do not mix paper types in a tray.
- Use only recommended print media. (See "In the multi-purpose tray" on page 96)
- Ensure that the recommended side of the print media is facing down in the tray, or facing down in the multi-purpose tray.
- If paper jams occur frequently when you print on A5/B5-sized paper: Load the paper into the tray with the long edge facing the front of the tray. If load the paper this way, printing both sides of the paper (Duplex) is not supported.

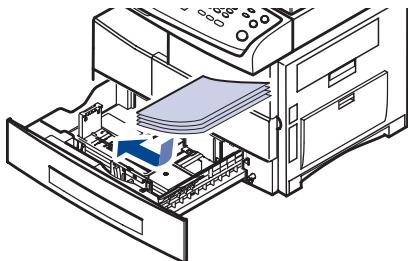

In the printer properties window, set the page orientation to be rotated 90 degrees. See *Software section*.

## CLEARING DOCUMENT JAMS

When an original jams while passing through the DADF, the warning message appears on the display screen.

 To avoid tearing the document, remove the jammed document gently and slowly.

 To prevent document jams, use the scanner glass for thick, thin, or mixed paper-type originals.

1. Remove any remaining pages from the DADF.
2. Open the DADF cover.

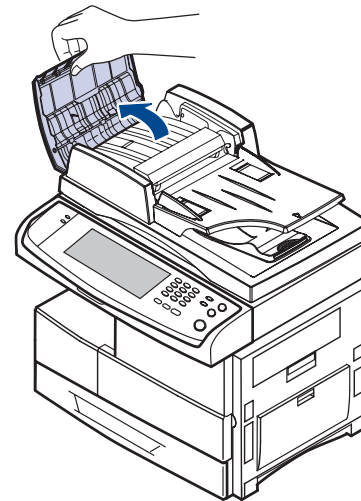

3. Gently remove the jammed paper from the DADF.



 If you see no paper in this area, refer to Roller misfeed. (See "In the multi-purpose tray" on page 96)

4. Close the DADF cover. Then reload the pages you removed, if any, in the DADF.

## Misfeed of exiting paper

1. Remove the remaining documents from the DADF.
2. Open the DADF cover.

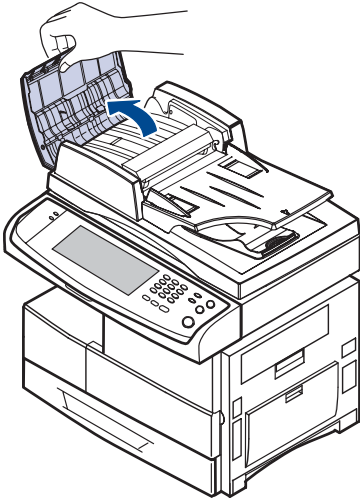

3. Open the document input tray upwards and pull the document gently out of the DADF.

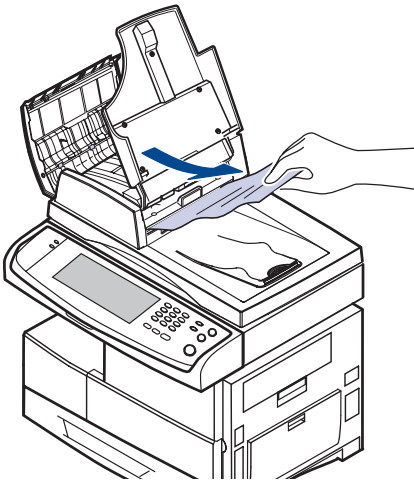

4. Close the DADF cover and the document input tray. Then place the documents back in the DADF.

## Roller misfeed

1. Open the scanner lid.
2. Grasp the misfeed paper, and remove the paper from the feed area by carefully pulling it to the right using both hands.

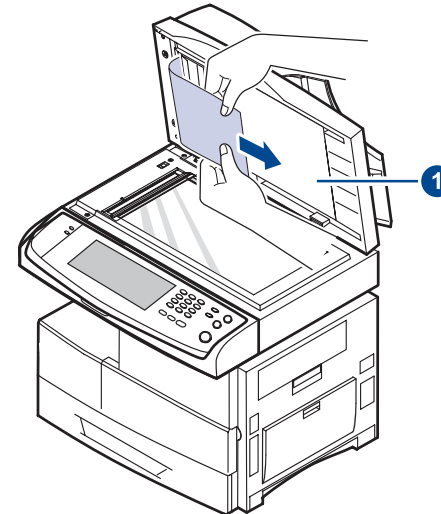

1 scanner lid

If you do not see the paper in this area, stop and go to step 3.

3. Open the white document background.

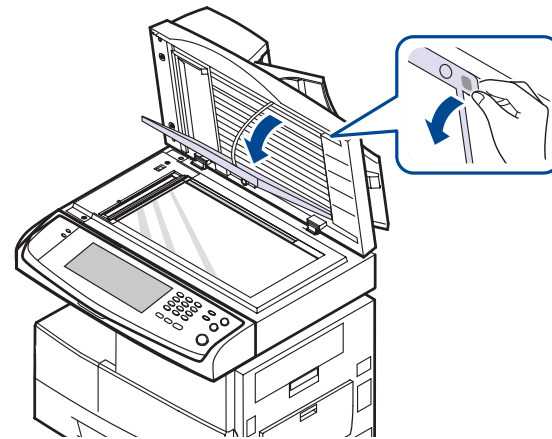

4. Remove the paper from the feed area by carefully pulling.

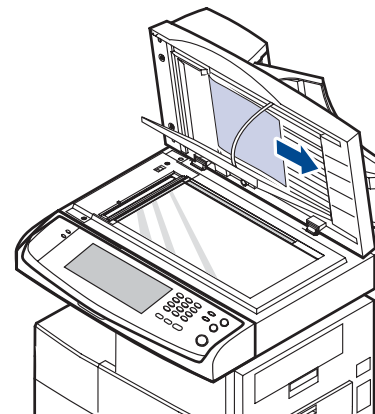

- Close the white document background and the scanner lid. Then load the removed pages back into the DADF.

## CLEARING PAPER JAMS

When a paper jam occurs, the warning message appears on the display screen. Refer to the table below to locate and clear the paper jam.

MESSAGE	LOCATION OF JAM	GO TO
<b>Paper Jam in tray 1, Paper Jam in tray 2, Paper Jam in tray 2 (HCF), Paper Jam in tray 3, Paper Jam in tray 3 (HCF), Paper Jam in tray 4, Paper Jam in MP tray</b>	In the paper feed area (tray 1, optional tray, or multi-purpose tray)	See "In the multi- purpose tray" on page 95. See "In the multi- purpose tray" on page 96 See "In the multi- purpose tray" on page 96
<b>Paper Jam in exit area</b>	In the fuser area or around the toner cartridge	See "In the multi- purpose tray" on page 96
<b>Paper Jam inside of machine</b>	In the paper exit area	See "In the multi- purpose tray" on page 96
<b>Paper Jam at the bottom of duplex path, Paper Jam at the top of duplex path, Paper Jam inside of duplex path</b>	In the duplex unit	See "In the multi- purpose tray" on page 96
<b>Paper jam in front of finisher</b>	In the stacker unit	See "In the multi- purpose tray" on page 96
<b>Paper jam inside finisher, Paper jam inside finisher's duplex</b>	In the stacker unit	See "In the multi- purpose tray" on page 96
<b>Paper jam at exit of finisher</b>	In the stacker unit	See "In the multi- purpose tray" on page 96

 To avoid tearing the paper, pull the jammed paper out gently and slowly. Follow the instructions in the following sections to clear the jam.

### In the tray 1

- Pull out the paper tray to open. After you pull it out completely, lift the front part of the tray up slightly to release the tray from the machine.

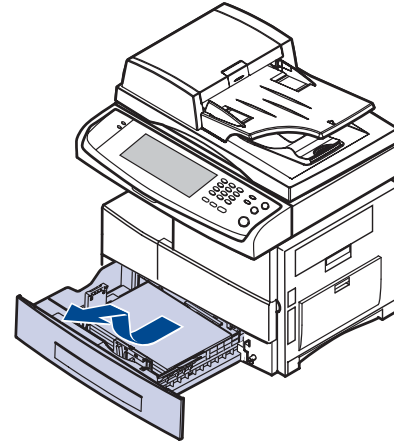

- Remove the jammed paper by gently pulling it straight out.

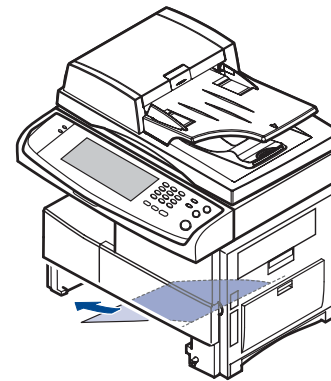

Once you remove the jammed paper here, open the side cover and then close it to clear the error message on the display.

If there is any resistance, and the paper does not move immediately when you pull, stop pulling. Then:

- Open the side cover.

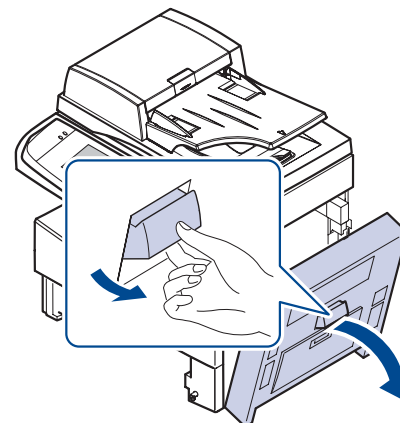

 Do not touch the shiny imaging unit surface. Scratches or smudges will result in poor print quality.

4. Carefully remove the misfeed paper in the direction shown.

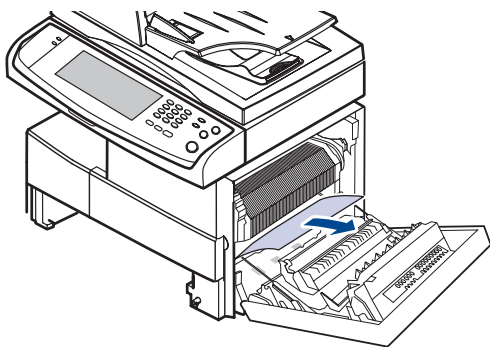

5. Close the side cover and insert the paper tray. Lower the rear part of the Tray to align the rear edge with the corresponding slot of the machine, then insert it completely.

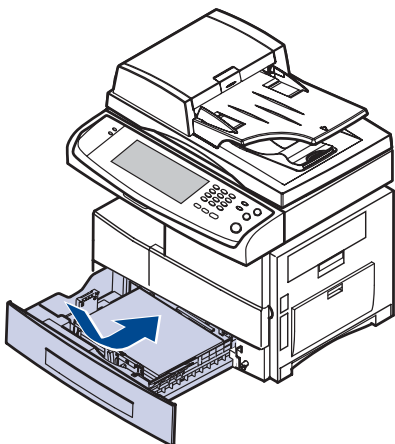

## In the optional tray

 This part explains the method of removing the jammed paper in the optional tray 2. Please refer to the next method for other optional trays, since the method is same as the tray 2.

1. Open the outer cover in tray 2.

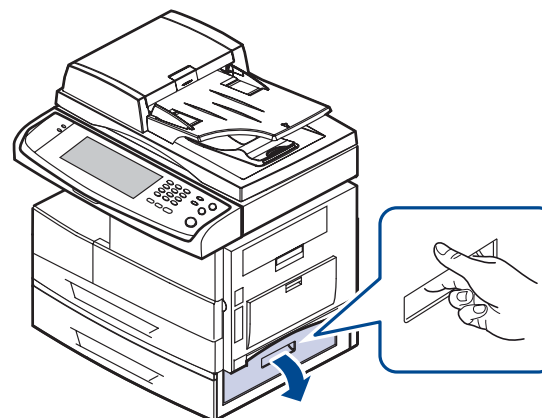

2. Open the inner cover of tray 2.

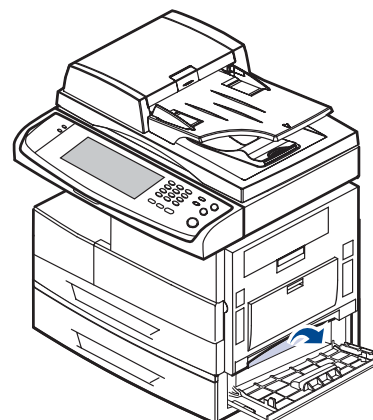

3. Pull the jammed paper out in the direction shown. To avoid tearing the paper, pull it out gently and slowly.

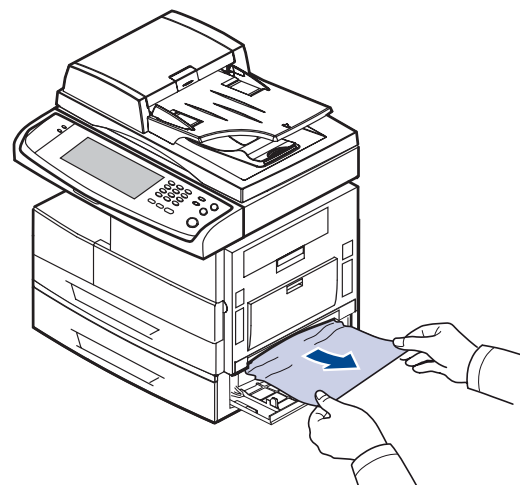

If the paper does not move when you pull, or if you do not see the paper

in this area, stop and go to step 4.

4. Pull out the optional tray 2.
5. Lift the front part of the tray slightly up to release the tray from the machine.

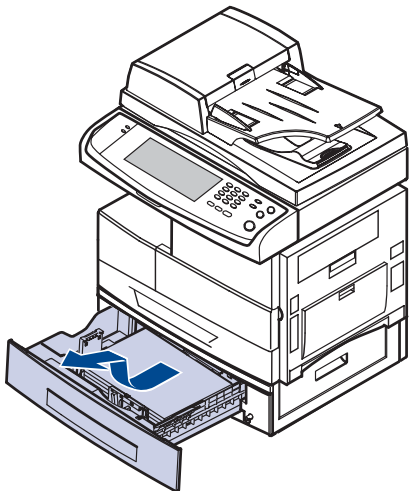

If the paper does not move when you pull, or if you do not see the paper in this area, stop and go to step 6.

6. Remove the paper in the direction shown. To avoid tearing the paper, pull it out gently and slowly.

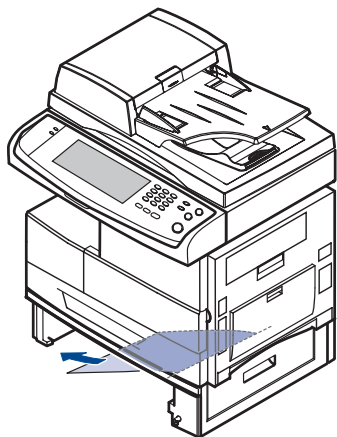

7. Insert the tray 2 and close the two covers.

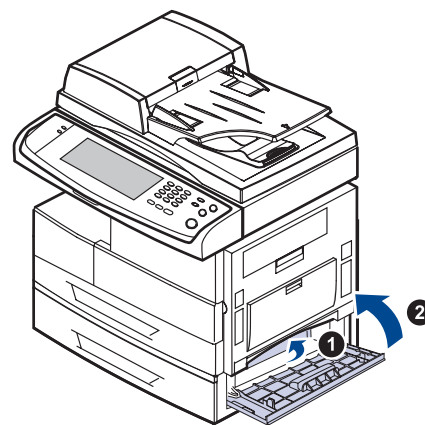

### In the optional high capacity feeder

1. Open the outer cover of the high capacity feeder.

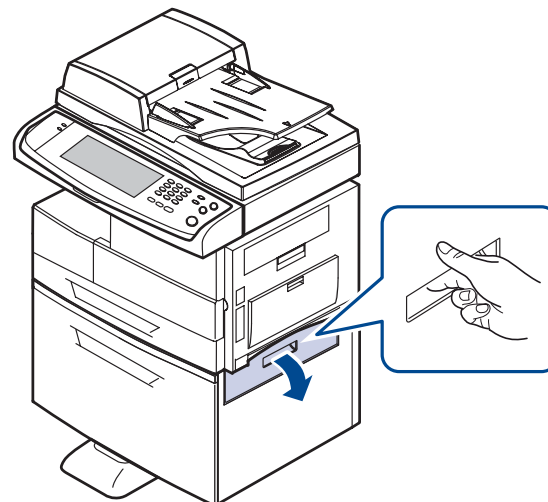

2. Open the inner cover of the high capacity feeder.

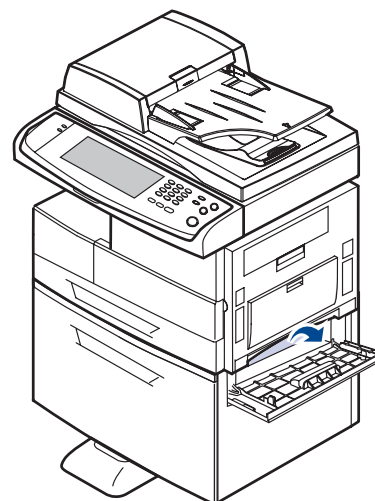



3. Pull the jammed paper out, in the direction shown, pulling gently and slowly in order to avoid tearing the paper.

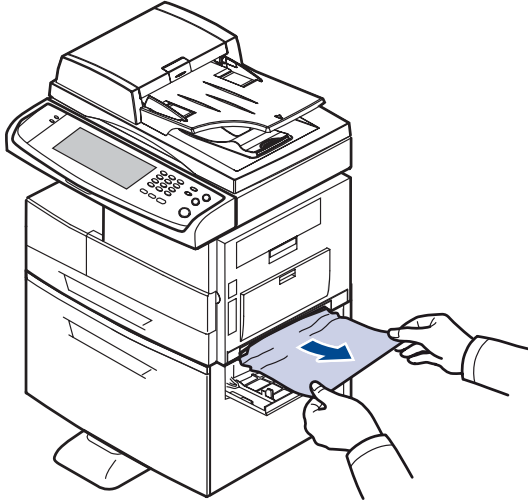

If the paper does not move when you pull, or if you do not see the paper in this area, stop and go to step 4.

4. Pull out the optional high capacity feeder.  
5. Lift the front part of the tray slightly up to release the tray from the machine.

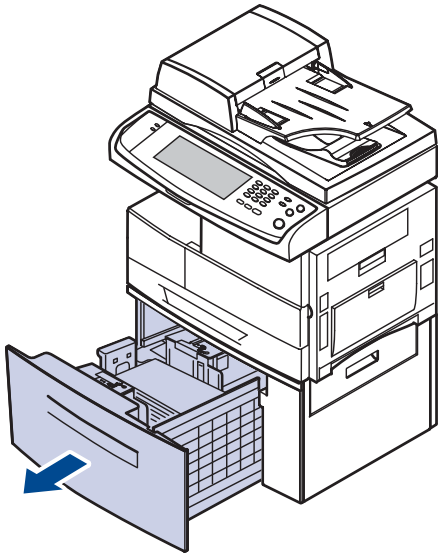

If the paper does not move when you pull, or if you do not see the paper in this area, stop and go to step 6.  
If you do not see any paper in this area, stop and go to step 6.

6. Remove the paper in the direction shown. Pull it out gently and slowly in order to avoid tearing the paper.

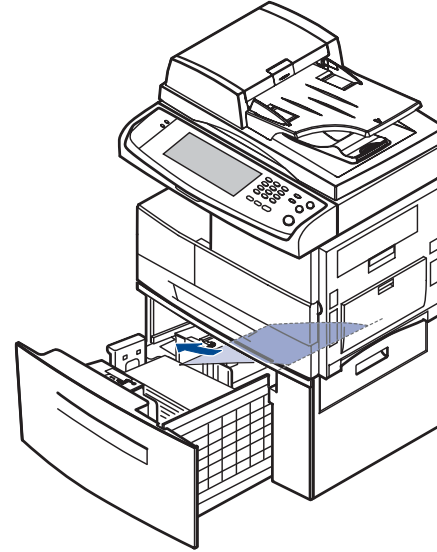

7. Insert the optional high capacity feeder and close the two covers.

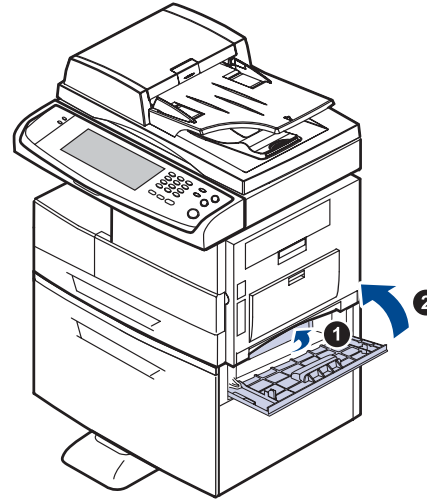



### In the multi-purpose tray

1. If the paper is not feeding properly, pull the paper out of the machine.

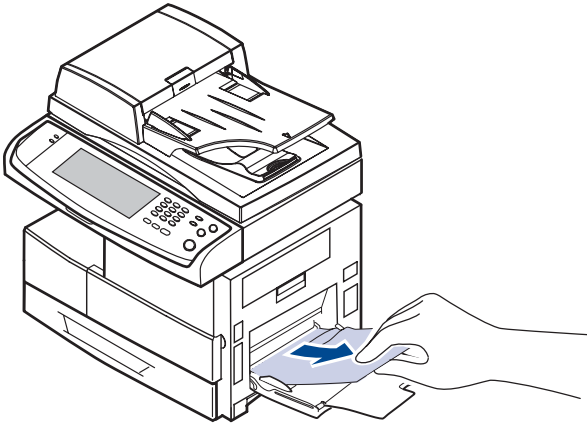

2. Open and close the side cover. Printing automatically resumes.

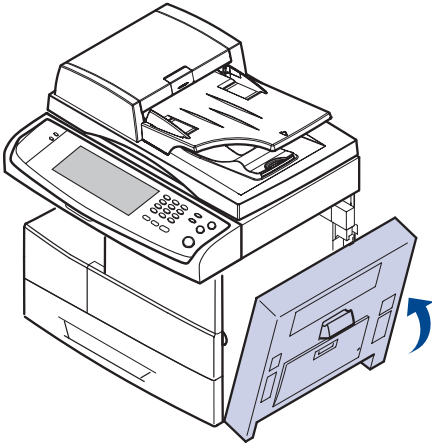

### In the fuser area or around the toner cartridge

 The fuser area is hot. Take care when removing paper from the machine.

1. Open the side cover.

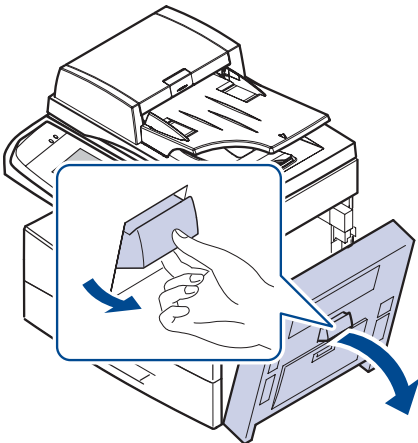

2. Remove the jammed paper, in the direction shown.

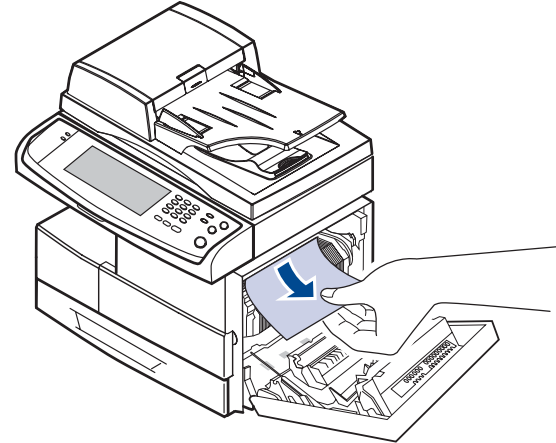

3. Close the side cover.

### In the paper exit area

1. Open the side cover.
2. Gently pull the paper out through the exit area.

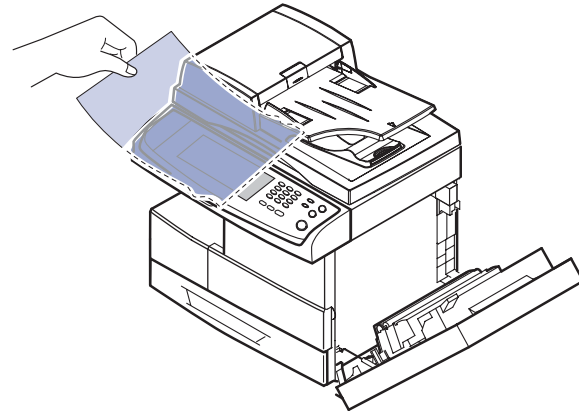

3. Close the side cover. Printing automatically resumes.

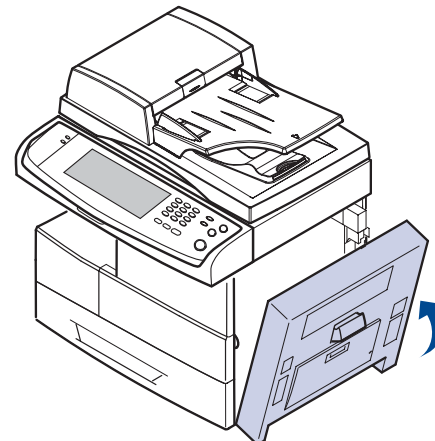

## In the duplex unit area

If the duplex unit is not inserted correctly, paper jam may occur. Make sure that the duplex unit is inserted correctly.

1. Open the side cover.
2. Release the guide to pull the jammed paper easily.

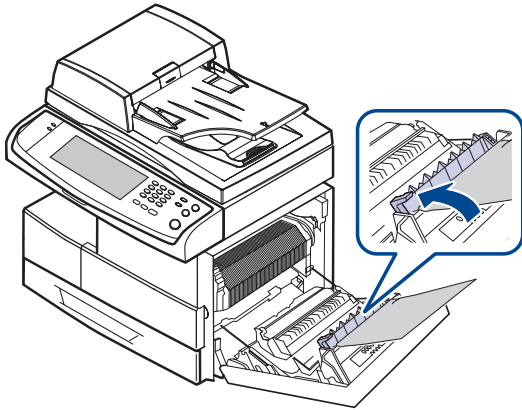

3. Remove the jammed paper.

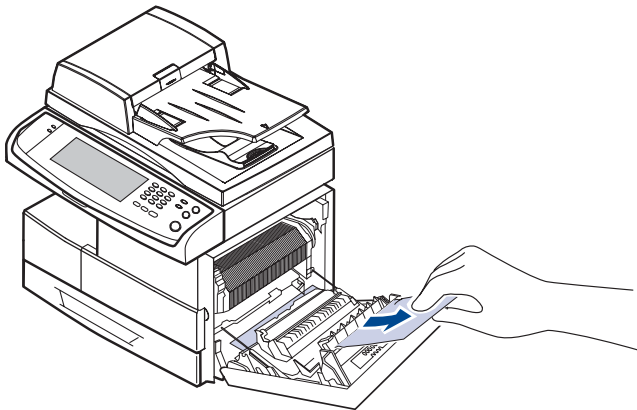

4. Close the side cover.

## In the stacker (finisher)

### Paper jam in front of finisher

1. Open the stacker front cover.

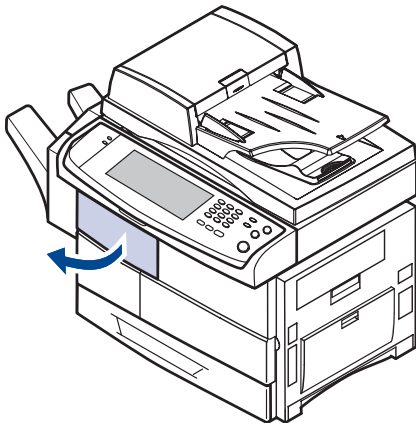

2. Press the right part of lever (1c) and hold still, then push the stacker to the left to release the stacker.

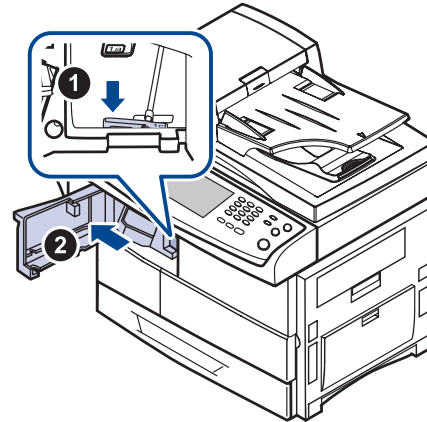

3. Remove the jammed paper.
4. Slide in the stacker until you hear the sound 'click'.
5. Close the stacker front cover.

### Paper jam inside finisher, Paper jam inside finisher's duplex

1. Open the stacker front cover.

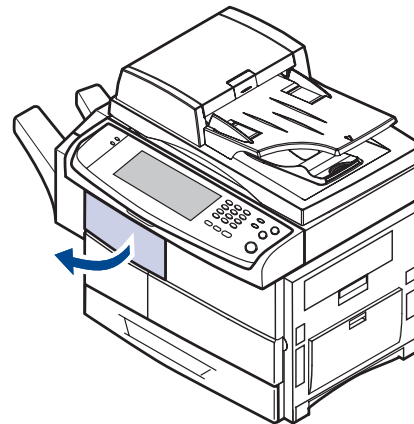

2. Pull the stacker lever 1a down. If necessary, pull the stacker lever 1b down as well.

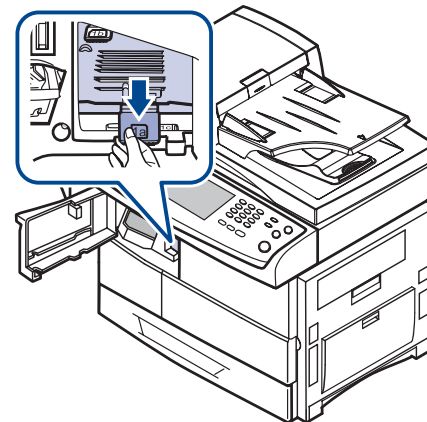

3. Remove the jammed paper.

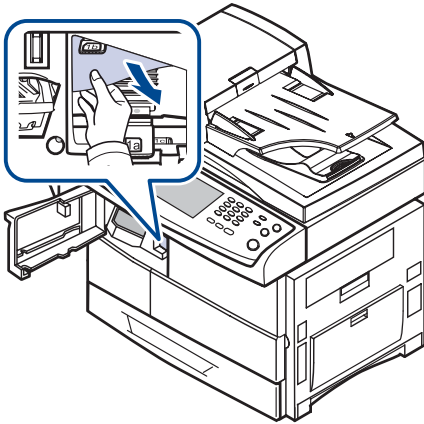

4. Pull up on the stacker lever and then close the stacker front cover.

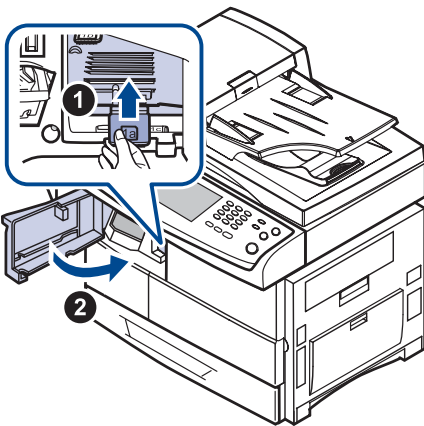

### Paper jam at exit of finisher

1. Gently pull the paper out through the exit area.

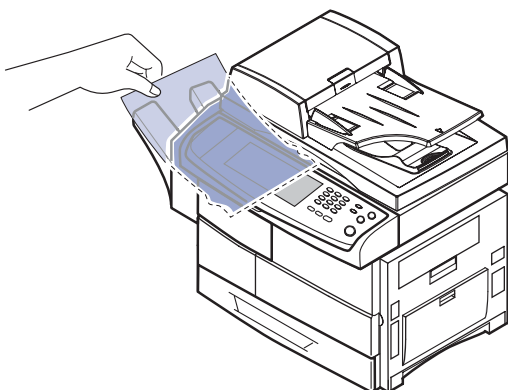

## UNDERSTANDING DISPLAY MESSAGES

Messages appear on the Smart Panel program window or on the control panel display to indicate machine status or errors. Refer to the tables below to understand the messages meaning to correct the problem, if necessary. Messages and their explanations are listed in alphabetical order.

- If the message is not in the table, cycle the power and try the printing job again. If the problem persists, call for service.
- When you call for service, it is very convenient to provide the service representative with the contents of display message.
- Some messages may not appear in the display depending on options or models.
- [yyy] indicates the part of the machine.
- [zzz] indicates the error code. When you contact the service center, this error code help to handle the problem.

MESSAGE	MEANING	SUGGESTED SOLUTIONS
<b>[yyy] is worn. Replace with new one</b>	The life of the part expires totally.	Replace the part with a new one. Call for service.
<b>DC motor does not operate: [zzz]. Please turn off then on</b>	There is a problem in the control of DC motor unit.	Turn the machine off and turn it on again. If the problem persists, please call for service.
<b>Did not supply enough toner. Remove seal tape &amp; reinstall</b>	Not supplied toner to the imaging unit.	<ul style="list-style-type: none"> <li>• Remove the sealing tape from the imaging unit.</li> <li>• Thoroughly roll the toner cartridge five or six times, and reinstall it.</li> <li>• Turn the machine off and turn it on again.</li> </ul>
<b>Did not supply enough toner. Please open/close door</b>	The machine received several papers with many images, and it cannot supply the toner properly.	Open side door and close it. If the problem still persists, please call for service.
<b>Fax memory is almost full. Print or remove received fax Job</b>	There is no more available fax memory. No more fax data can be received.	Delete the received fax data in the memory to secure memory. Call for service.
<b>Fax memory is full. Print or remove received fax Job</b>	Available fax memory is now 1MB.	Delete the received fax data in the memory to secure memory. Call for service.
<b>Finisher door is open. Close it</b>	The finisher cover is not securely latched.	Close the finisher until it locks into place.
<b>Finisher error: [zzz]. Please turn off then on</b>	There is a problem in the finisher unit.	Turn the machine off and reinstall the finisher again. Check that the finisher cable is connected properly. If the problem persists, please call for service.

MESSAGE	MEANING	SUGGESTED SOLUTIONS
<b>Fuser error: [zzz]. Please turn off then on</b>	There is a problem in the fuser unit working.	Turn the machine off and turn it on again. If the problem persists, please call for service.
<b>Fuser unit is not installed correctly. Install it</b>	The fuser unit is not installed or correctly.	Install the fuser unit. Call for service.
<b>End of life, Replace with new imaging unit</b>	The toner in the imaging unit has run out.	Replace the imaging unit with a Samsung-genuine toner cartridge. (See "In the multi-purpose tray" on page96)
<b>Imaging unit is not compatible. Check user's guide</b>	The imaging unit you have installed is not for your machine.	Install a Samsung-genuine imaging unit, designed for your machine.
<b>Imaging unit is not installed. Install it</b>	The imaging unit is not installed, or the CRUM (Consumer Replaceable Unit Monitor) in the cartridge is not connected.	Install the imaging unit. If it is already installed, try to reinstall the imaging unit. If the problem persists, please call for service.
<b>Replace with new imaging unit</b>	The imaging unit is at the end of its life. When the imaging unit replacement message appears on the screen and if you select <b>Continue</b> , this message displays.	Replace a imaging unit with a Samsung-genuine imaging unit. (See "In the multi-purpose tray" on page96)
<b>LSU error: [zzz]. Please turn off then on</b>	There is a problem in the control of LSU unit.	Turn the machine off and turn it on again. If the problem persists, please call for service.
<b>Motor does not operate: [zzz]. Please turn off then on</b>	There is a problem in the control of motor unit.	Turn the machine off and turn it on again. If the problem persists, please call for service.
<b>Original paper does not feed in scanner</b>	The lead edge of the document failed to actuate the scan sensor within the correct time after actuating the registration sensor.	Open the DADF cover and remove jammed original. (See "In the multi-purpose tray" on page96)

MESSAGE	MEANING	SUGGESTED SOLUTIONS
<b>Original paper is too long for scanner. Check size</b>	Oversized document or double-feeding of originals.	Open the DADF cover and remove the jammed original. (See "In the multi-purpose tray" on page96) Check the document size whether it is supported. (See "In the multi-purpose tray" on page96)
<b>Original paper jam in front of scanner</b>	The originals are jammed in DADF.	Open the DADF cover and remove the jammed original. (See "In the multi-purpose tray" on page96)
<b>Original paper jam in front of scanner duplex path</b>	Paper has jammed during duplex printing in the DADF.	Clear the jam. (See "In the multi-purpose tray" on page96)
<b>Original paper jam inside of scanner</b>	The lead edge of the document failed to actuate the gate sensor within the correct time after actuating the scan sensor. When the machine is on, jammed paper is detected in the DADF.	Open the DADF cover and remove the jammed original. (See "In the multi-purpose tray" on page96)
<b>Original paper jam while reversing paper in scanner</b>	The lead edge of the document failed to actuate the duplex sensor within the correct time when the document was fed the wrong way.	Lift up the document input tray and remove the jammed original. (See "In the multi-purpose tray" on page96)
<b>Paper jam at exit of finisher</b>	Paper jammed in the stacker exit part.	Pull jammed paper from the stacker exit.
<b>Paper Jam at the bottom of duplex path</b>	Paper has jammed during duplex printing.	Clear the jam. (See "In the multi-purpose tray" on page96)
<b>Paper Jam at the top of duplex path</b>		
<b>Paper Jam in exit area</b>	Paper has jammed in the fuser area.	Clear the jam. (See "In the multi-purpose tray" on page96)
<b>Paper jam in front of finisher</b>	Paper jammed in the stacker.	Open the stacker door and remove jammed paper by lowering guide 1a or 1b.
<b>Paper jam inside finisher</b>		
<b>Paper Jam in MP tray</b>	Paper Misfed from multi-purpose tray	Clear the jam. (See "In the multi-purpose tray" on page96)



MESSAGE	MEANING	SUGGESTED SOLUTIONS
<b>Paper Jam in tray 1</b>	Paper misfed from tray Or paper has jammed in the tray feed area. Or the tray cover is opened.	Clear the jam. (See "In the tray 1" on page 91 and see "In the optional tray" on page 92 and see "In the optional high capacity feeder" on page 93)
<b>Paper Jam in tray 2</b>		
<b>Paper Jam in tray 2 (HCF)</b>		
<b>Paper Jam in tray 3</b>		
<b>Paper Jam in tray 3 (HCF)</b>		
<b>Paper Jam in tray 4</b>		
<b>Paper jam inside finisher's duplex</b>	Paper jammed in the stacker.	Open the stacker door and remove jammed paper by lowering guide 1a or 1b.
<b>Paper Jam inside of duplex path</b>	Paper has jammed during duplex printing.	Clear the jam. (See "In the multi-purpose tray" on page96)
<b>Paper Jam inside of machine</b>	Paper has jammed in the registration area.	Clear the jam. (See "In the multi-purpose tray" on page96)
<b>Scanner locking switch is locked or another problem occurred</b>	The CCD (Charged Couple Device) lock has been locked. The CCD does not detect its home location or move.	Unlock the CCD lock. (See "In the multi-purpose tray" on page96) Or turn off the machine and on again. Try again. If the problem persists, call for service.
<b>Shake toner cartridge</b>	The toner supply is low.	Thoroughly roll the new cartridge five or six times to distribute the toner evenly inside the cartridge.
<b>Staple cartridge is empty. Replace it</b>	Stapler is run out.	Order Staple Cartridge. (See "In the multi-purpose tray" on page96) And replace it. (See "In the multi-purpose tray" on page96)
<b>Staple cartridge is not installed. Install it in finisher</b>	The staple cartridge is not installed.	Install the staple cartridge following the steps explained on the back of the finisher door. (See "In the multi-purpose tray" on page96) If you want to continue the print job and disregard of this error message, go to <b>Admin Setting</b> to adjust the option. (See "In the multi-purpose tray" on page96)

MESSAGE	MEANING	SUGGESTED SOLUTIONS
<b>System error: [zzz]. Please turn off then on</b>	There is a problem in the system operation.	Turn the machine off and turn it on again. If the problem persists, please call for service.
<b>This IP address conflicts with an IP address already in use. Check it</b>	The IP address is used in other place elsewhere.	Check the IP address or obtain a new IP address.
<b>Toner cartridge is not compatible. Check user's guide</b>	The toner cartridge you have installed is not for your machine.	Install a Samsung-genuine toner cartridge, designed for your machine.
<b>Toner cartridge is not installed. Install it</b>	The toner cartridge is not installed or the CRUM (Consumer Replaceable Unit Monitor) in the cartridge is not properly connected.	Try to reinstall the toner cartridge.
<b>Replace with new toner cartridge</b>	The toner cartridge is at the end of its life. When the toner cartridge replacement message appears on the screen and if you select <b>Continue</b> , this message displays.	Rplace a toner cartridge with a Samsung-genuine toner cartridge. (See "In the multi-purpose tray" on page96)
<b>End of life, Replace with new toner cartridge</b>	The lifespan of the toner cartridge which the arrow indicates is reached.	This message appears when the toner is completely empty, and your machine stops printing. Replace the toner cartridge with a Samsung-genuine toner cartridge. (See "In the multi-purpose tray" on page96)
<b>Prepare new toner cartridge</b>	The toner cartridge is almost empty.	Ensure a replacement cartridge is in stock.
<b>Too much paper in finisher stacker. Remove printed paper</b>	The stacker is full of printouts.	Remove printouts from the stacker.
<b>Too much paper in output bin tray. Remove printed paper</b>	The printed papers are full on the output tray.	Remove printed outs from the output tray.
<b>Use Auxiliary Access</b>	The credit is not enough to access the job according to Foreign Device.	Insert credit into the Foreign Device.

## SOLVING OTHER PROBLEMS

The following chart lists some conditions that may occur and the recommended solutions. Follow the suggested solutions until the problem is corrected. If the problem persists, please call for service.

### Touch screen problem

CONDITION	SUGGESTED SOLUTIONS
<b>The touch screen does not show anything.</b>	Turn the machine off and turn it on again. If the problem persists, please call for service.

### Paper feeding problems

CONDITION	SUGGESTED SOLUTIONS
<b>Paper is jammed during printing.</b>	Clear the paper jam. (See "In the multi-purpose tray" on page96)
<b>Paper sticks together.</b>	<ul style="list-style-type: none"> <li>• Check the maximum paper capacity of the tray. (See "In the multi-purpose tray" on page96)</li> <li>• Make sure that you are using the correct type of paper. (See "In the multi-purpose tray" on page96)</li> <li>• Remove paper from the tray and flex or fan the paper.</li> <li>• Humid conditions may cause some paper to stick together.</li> </ul>
<b>Multiple sheets of paper do not feed.</b>	<ul style="list-style-type: none"> <li>• Different types of paper may be stacked in the tray. Load paper of only one type, size, and weight.</li> <li>• If multiple sheets have caused a paper jam, clear the paper jam. (See "In the multi-purpose tray" on page96)</li> </ul>
<b>Paper does not feed into the machine.</b>	<ul style="list-style-type: none"> <li>• Remove any obstructions from inside the machine.</li> <li>• Paper has not been loaded correctly. Remove paper from the tray and reload it correctly.</li> <li>• There is too much paper in the tray. Remove excess paper from the tray.</li> <li>• The paper is too thick. Use only paper that meets the specifications required by the machine. (See "In the multi-purpose tray" on page96)</li> <li>• If an original does not feed into the machine, the DADF rubber pad may require to be replaced. Contact a service representative.</li> </ul>

CONDITION	SUGGESTED SOLUTIONS
<b>The paper keeps jamming.</b>	<ul style="list-style-type: none"> <li>• There is too much paper in the tray. Remove excess paper from the tray. If you are printing on special materials, use the multi-purpose tray.</li> <li>• An incorrect type of paper is being used. Use only paper that meets the specifications required by the machine. (See "In the multi-purpose tray" on page96)</li> <li>• There may be debris inside the machine. Open the front cover and remove the debris.</li> <li>• If an original does not feed into the machine, the DADF rubber pad may need to be replaced. Contact a service representative.</li> </ul>
<b>Transparencies stick together in the paper exit.</b>	Use only transparencies specifically designed for laser printers. Remove each transparency as it exits from the machine.
<b>Envelopes skew or fail to feed correctly.</b>	Ensure that the paper guides are against both sides of the envelopes.



## Printing problems

CONDITION	POSSIBLE CAUSE	SUGGESTED SOLUTIONS
<b>The machine does not print.</b>	The machine is not receiving power.	Check the power cord connections. Check the power switch and the power source.
	The machine is not selected as the default printer.	Select Samsung SCX-6x55X Series PCL 6 or Samsung SCX-6x55X Series PS as your default printer in your Windows.
	Check the machine for the following: <ul style="list-style-type: none"> <li>• The side cover is not closed. Close the side cover.</li> <li>• Paper is jammed. Clear the paper jam. (See "In the multi-purpose tray" on page96)</li> <li>• No paper is loaded. Load paper. (See "In the multi-purpose tray" on page96)</li> <li>• The toner cartridge or the imaging unit is not installed. Install the toner cartridge or the imaging unit.</li> </ul> If a system error occurs, contact your service representative.	
	The connection cable between the computer and the machine is not connected properly.	Disconnect the printer cable and reconnect it.
	The connection cable between the computer and the machine is defective.	If possible, attach the cable to another computer that is working properly and print a job. You can also try using a different printer cable.
	The port setting is incorrect.	Check the Windows printer setting to make sure that the print job is sent to the correct port. If the computer has more than one port, make sure that the machine is attached to the correct one.
	The machine may be configured incorrectly.	Check the printer properties to ensure that all of the print settings are correct.
	The printer driver may be incorrectly installed.	Repair the printer software. See <i>Software section</i> .
The machine is malfunctioning.	Check the display message on the control panel to see if the machine is indicating a system error. Contact a service representative.	

CONDITION	POSSIBLE CAUSE	SUGGESTED SOLUTIONS
<b>The machine does not print. (Continued)</b>	The document size is so big that the hard disk space of the computer is not enough to access the print job.	Get more hard disk space and print the document again.
<b>The machine selects print materials from the wrong paper source.</b>	The paper option that was selected in the printer properties may be incorrect.	For many software applications, the paper source selection is found under the <b>Paper</b> tab within the printer properties. Select the correct paper source. See the printer driver help screen.
<b>A print job is extremely slow.</b>	The job may be very complex.	Reduce the complexity of the page or try adjusting the print quality settings.
<b>Half the page is blank.</b>	The page orientation setting may be incorrect.	Change the page orientation in your application. See the printer driver help screen.
	The paper size and the paper size settings do not match.	Ensure that the paper size in the printer driver settings matches the paper in the tray. Or, ensure that the paper size in the printer driver settings matches the paper selection in the software application settings you use.
<b>The machine prints, but the text is wrong, garbled, or incomplete.</b>	The printer cable is loose or defective.	Disconnect the printer cable and reconnect. Try a print job that you have already printed successfully. If possible, attach the cable and the machine to another computer and try a print job that you know works. Finally, try a new printer cable.
	The wrong printer driver was selected.	Check the application's printer selection menu to ensure that your machine is selected.
	The software application is malfunctioning.	Try printing a job from another application.
	The operating system is malfunctioning.	Exit Windows and reboot the computer. Turn the machine off and then back on again.

CONDITION	POSSIBLE CAUSE	SUGGESTED SOLUTIONS
<b>Pages print, but they are blank.</b>	The toner cartridge is defective or out of toner.	Redistribute the toner, if necessary. If necessary, replace the toner cartridge.
	The file may have blank pages.	Check the file to ensure that it does not contain blank pages.
	Some parts, such as the controller or the board, may be defective.	Contact a service representative.
<b>The printer does not print PDF file correctly. Some parts of graphics, text, or illustrations are missing.</b>	Incompatibility between the PDF file and the Acrobat products.	Printing the PDF file as an image may enable the file to print. Turn on <b>Print As Image</b> from the Acrobat printing options.   It will take longer to print when you print a PDF file as an image.
<b>Your machine has an odd smell during initial use.</b>	The oil used to protect the fuser is evaporating.	After printing about 100 color pages, there will be no more smell. It is a temporary issue.
<b>The print quality of photos is not good. Images are not clear.</b>	The resolution of the photo is very low.	Reduce the photo size. If you increase the photo size in the software application, the resolution will be reduced.
<b>The machine prints, but the text is wrong, garbled, or incomplete.</b>	If you are under the DOS environment, the font setting for your machine may be set incorrectly.	Suggested solutions: Change the language setting. (See "In the multi-purpose tray" on page96)
<b>Before printing, the machine emits vapor near the output tray.</b>	Using damp paper can cause vapor during printing.	This is not a problem. Just keep printing.



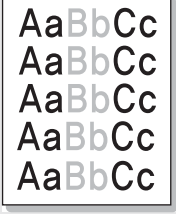
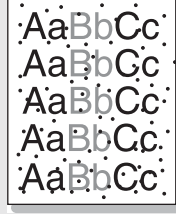
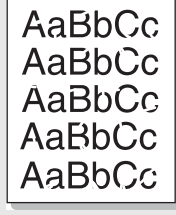

## Printing quality problems

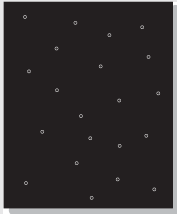
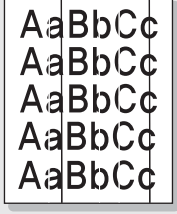
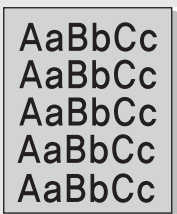
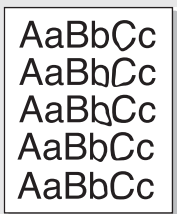
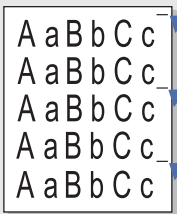
If the inside of the machine is dirty or paper has been loaded improperly, you may notice a reduction in print quality. See the table below to clear the problem.

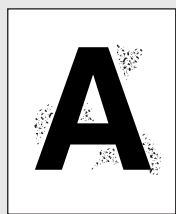
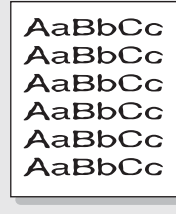
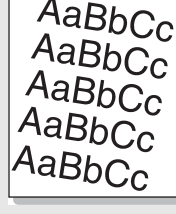
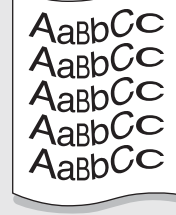
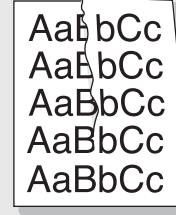
CONDITION	SUGGESTED SOLUTIONS
<b>Light or faded print</b> 	<p>If a vertical white streak or faded area appears on the page:</p> <ul style="list-style-type: none"> <li>The toner supply is low. You may be able to temporarily extend the toner cartridge life. If this does not improve the print quality, install a new toner cartridge.</li> <li>The paper may not meet paper specifications; for example, the paper may be too moist or rough. (See "In the multi-purpose tray" on page96)</li> <li>If the entire page is light, the print resolution setting is too low or the toner save mode is on. Adjust the print resolution and turn the toner save mode off. See the help screen of the printer driver and refer to <i>Software section</i>, respectively.</li> <li>A combination of faded or smeared defects may indicate that the toner cartridge needs cleaning. Contact a service representative.</li> <li>The surface of the LSU part inside the machine may be dirty. Clean the LSU, contact a service representative.</li> </ul>
<b>Toner specks</b> 	<ul style="list-style-type: none"> <li>The paper may not meet specifications; for example, the paper may be too moist or rough. (See "In the multi-purpose tray" on page96)</li> <li>The transfer roller may be dirty. Clean the inside of your machine. Contact a service representative.</li> <li>The paper path may need cleaning. Contact a service representative.</li> </ul>
<b>Dropouts</b> 	<p>If faded areas, generally rounded, occur randomly on the page:</p> <ul style="list-style-type: none"> <li>A single sheet of paper may be defective. Try reprinting the job.</li> <li>The moisture content of the paper is uneven or the paper has moist spots on its surface. Try a different brand of paper. (See "In the multi-purpose tray" on page96)</li> <li>The paper lot is bad. The manufacturing processes can cause some areas to reject toner. Try a different kind or brand of paper.</li> <li>Change the printer option and try again. Go to printer properties, click <b>Paper</b> tab, and set type to <b>Thick Paper</b>. Refer to the <i>Software section</i> for details.</li> <li>If these steps do not correct the problem, contact a service representative.</li> </ul>

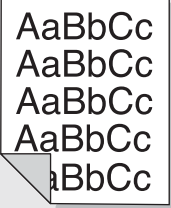
CONDITION	SUGGESTED SOLUTIONS
<b>White Spots</b> 	<p>White spots appears on the page:</p> <ul style="list-style-type: none"> <li>The paper is too rough and a lot of dirt from a paper falls to the inner devices within the machine, so the transfer roller may be dirty. Clean the inside of your machine. (See "In the multi-purpose tray" on page96) Contact a service representative.</li> <li>The paper path may need cleaning. Contact a service representative.</li> </ul>
<b>Vertical lines</b> 	<p>If black vertical streaks appear on the page:</p> <ul style="list-style-type: none"> <li>The surface(drum part) of the imaging unit inside the machine has probably been scratched. Remove the imaging unit and install a new one. (See "In the multi-purpose tray" on page96)</li> </ul> <p>If white vertical streaks appear on the page:</p> <ul style="list-style-type: none"> <li>The surface of the LSU part inside the machine may be dirty. Clean the LSU. Contact a service representative.</li> </ul>
<b>Color or Black background</b> 	<p>If the amount of background shading becomes unacceptable:</p> <ul style="list-style-type: none"> <li>Change to a lighter weight paper. (See "In the multi-purpose tray" on page96)</li> <li>Check the environmental conditions: very dry conditions (low humidity) or a high level of humidity (higher than 80% RH) can increase the amount of background shading.</li> <li>Remove the old imaging unit and then, install a new one. (See "In the multi-purpose tray" on page96)</li> </ul>
<b>Toner smear</b> 	<ul style="list-style-type: none"> <li>Clean the inside of the machine. Contact a service representative.</li> <li>Check the paper type and quality. (See "In the multi-purpose tray" on page96)</li> <li>Remove the imaging unit and then, install a new one. (See "In the multi-purpose tray" on page96)</li> </ul>
<b>Vertical repetitive defects</b> 	<p>If marks repeatedly appear on the printed side of the page at even intervals:</p> <ul style="list-style-type: none"> <li>The imaging unit may be damaged. If a repetitive mark occurs on the page, run a cleaning sheet through several times to clean the cartridge; contact a service representative. After the printout, if you still have the same problems, remove the imaging unit and then, install a new one. (See "In the multi-purpose tray" on page96)</li> <li>Parts of the machine may have toner on them. If the defects occur on the back of the page, the problem will likely correct itself after a few more pages.</li> <li>The fusing assembly may be damaged. Contact a service representative.</li> </ul>

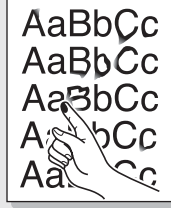
CONDITION	SUGGESTED SOLUTIONS
<b>Background scatter</b> 	<p>Background scatter results from bits of toner randomly distributed on the printed page.</p> <ul style="list-style-type: none"> <li>The paper may be too damp. Try printing with a different batch of paper. Do not open packages of paper until necessary so that the paper does not absorb too much moisture.</li> <li>If background scatter occurs on an envelope, change the printing layout to avoid printing over areas that have overlapping seams on the reverse side. Printing on seams can cause problems.</li> <li>If background scatter covers the entire surface area of a printed page, adjust the print resolution through your software application or in printer properties.</li> </ul>
<b>Misformed characters</b> 	<ul style="list-style-type: none"> <li>If characters are improperly formed and producing hollow images, the paper stock may be too slick. Try different paper. (See "In the multi-purpose tray" on page96)</li> <li>If characters are improperly formed and producing a wavy effect, the scanner unit may need service. Contact a service representative.</li> </ul>
<b>Page skew</b> 	<ul style="list-style-type: none"> <li>Ensure that the paper is loaded properly.</li> <li>Check the paper type and quality. (See "In the multi-purpose tray" on page96)</li> <li>Ensure that the paper or other material is loaded correctly and the guides are not too tight or too loose against the paper stack.</li> </ul>
<b>Curl or wave</b> 	<ul style="list-style-type: none"> <li>Ensure that the paper is loaded properly.</li> <li>Check the paper type and quality. Both high temperature and humidity can cause paper curl. (See "In the multi-purpose tray" on page96)</li> <li>Turn the stack of paper over in the tray. Also try rotating the paper 180° in the tray.</li> </ul>
<b>Wrinkles or creases</b> 	<ul style="list-style-type: none"> <li>Ensure that the paper is loaded properly.</li> <li>Check the paper type and quality. (See "In the multi-purpose tray" on page96)</li> <li>Turn the stack of paper over in the tray. Also try rotating the paper 180° in the tray.</li> </ul>

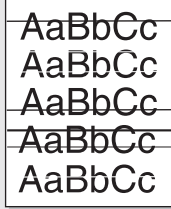
CONDITION	SUGGESTED SOLUTIONS
<p><b>Back of printouts are dirty</b></p> 	<p>Check for leaking toner. Clean the inside of the machine. Contact a service representative.</p>
<p><b>Solid Color or Black pages</b></p> 	<ul style="list-style-type: none"> <li>The imaging unit may not be installed properly. Remove the cartridge and reinsert it.</li> <li>The imaging unit may be defective and need replacing. Remove the imaging unit and install a new one. (See "In the multi-purpose tray" on page96)</li> <li>The machine may require repair. Contact a service representative.</li> </ul>
<p><b>Loose toner</b></p> 	<ul style="list-style-type: none"> <li>Clean the inside of the machine. Contact a service representative.</li> <li>Check the paper type and quality. (See "In the multi-purpose tray" on page96)</li> <li>Remove the imaging unit and then, install a new one. (See "In the multi-purpose tray" on page96)</li> <li>If the problem persists, the machine may require repair. Contact a service representative.</li> </ul>
<p><b>Character Voids</b></p> 	<p>Character voids are white areas within parts of characters that should be solid black:</p> <ul style="list-style-type: none"> <li>If you are using transparencies, try another type of transparency. Because of the composition of transparencies, some character voids are normal.</li> <li>You may be printing on the wrong surface of the paper. Remove the paper and turn it around.</li> <li>The paper may not meet paper specifications. (See "In the multi-purpose tray" on page96)</li> </ul>
<p><b>Horizontal stripes</b></p> 	<p>If horizontally aligned black streaks or smears appear:</p> <ul style="list-style-type: none"> <li>The imaging unit may be installed improperly. Remove the cartridge and reinsert it.</li> <li>The imaging unit may be defective. Remove the toner cartridge and install a new one. (See "In the multi-purpose tray" on page96)</li> <li>If the problem persists, the machine may require repair. Contact a service representative.</li> </ul>

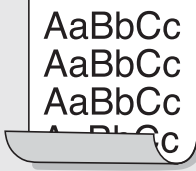
CONDITION	SUGGESTED SOLUTIONS
<p><b>Curl</b></p> 	<p>If the printed paper is curled or paper does not feed into the machine:</p> <ul style="list-style-type: none"> <li>Turn the stack of paper over in the tray. Also try rotating the paper 180° in the tray.</li> <li>Change the printer option and try again. Go to printer properties, click <b>Paper</b> tab, and set type to <b>Thin Paper</b>. Refer to the <i>Software section</i> for details.</li> </ul>
<p><b>An unknown image repetitively appears on a next few sheets or loose toner, light print, or contamination occurs.</b></p>	<p>Your printer is probably being used at an altitude of 1,000 m (3,281 ft) or above. The high altitude may affect the print quality such as loose toner or light imaging. You can set this option through <b>Paper</b> or <b>Printer</b> tab in printer driver's properties. (See "In the multi-purpose tray" on page96)</p>

## Copying problems

CONDITION	SUGGESTED SOLUTIONS
<p><b>Copies are too light or too dark.</b></p>	<p>Use <b>Light</b> and <b>Dark</b> arrows to darken or lighten the backgrounds of copies.</p>
<p><b>Smears, lines, marks, or spots appears on copies.</b></p>	<ul style="list-style-type: none"> <li>If the defects are on the original, press <b>Light</b> and <b>Dark</b> arrows to lighten the background of your copies.</li> <li>If there are no defects on the original, clean the scan unit. (See "In the multi-purpose tray" on page96)</li> </ul>
<p><b>Copy image is skewed.</b></p>	<ul style="list-style-type: none"> <li>Ensure that the original is face down on the scanner glass or face up in the DADF.</li> <li>Check that the copy paper is loaded correctly.</li> </ul>
<p><b>Blank copies print out.</b></p>	<p>Ensure that the original is face down on the scanner glass or face up in the DADF.</p>
<p><b>Image rubs off the copy easily.</b></p>	<ul style="list-style-type: none"> <li>Replace the paper in the tray with paper from a new package.</li> <li>In high humidity areas, do not leave paper in the machine for extended periods of time.</li> </ul>
<p><b>Frequent copy paper jams occur.</b></p>	<ul style="list-style-type: none"> <li>Fan the stack of paper, then turn it over in the tray. Replace the paper in the tray with a fresh supply. Check/adjust the paper guides, if necessary.</li> <li>Ensure that the paper is the proper paper weight. 75 g/m<sup>2</sup> bond paper is recommended.</li> <li>Check for copy paper or pieces of copy paper remaining in the machine after a paper jam has been cleared.</li> </ul>



CONDITION	SUGGESTED SOLUTIONS
<b>Toner cartridge produces fewer copies than expected before running out of toner.</b>	<ul style="list-style-type: none"> <li>Your originals may contain pictures, solids, or heavy lines. For example, your originals may be forms, newsletters, books, or other documents that use more toner.</li> <li>The machine may be turned on and off frequently.</li> <li>The scanner lid may be left open while copies are being made.</li> </ul>

## Scanning problems

CONDITION	SUGGESTED SOLUTIONS
<b>The scanner does not work.</b>	<ul style="list-style-type: none"> <li>Make sure that you place the original to be scanned face down on the scanner glass, or face up in the DADF.</li> <li>There may not be enough available memory to hold the document you want to scan. Try the Prescan function to see if that works. Try lowering the scan resolution rate.</li> <li>Check that the printer cable is connected properly.</li> <li>Make sure that the printer cable is not defective. Switch the cable with a known good cable. If necessary, replace the cable.</li> <li>Check that the scanner is configured correctly. Check scan setting in the <b>SmarThru Configuration</b> or the application you want to use to make certain that the scanner job is being sent to the correct port.</li> </ul>
<b>The unit scans very slowly.</b>	<ul style="list-style-type: none"> <li>Check if the machine is printing received data. If so, scan the document after the received data has been printed.</li> <li>Graphics are scanned more slowly than text.</li> <li>Communication speed slows in scan mode because of the large amount of memory required to analyze and reproduce the scanned image. Set your computer to the ECP printer mode through BIOS setting. It will help to increase the speed. For details about how to set BIOS, refer to your computer user's guide.</li> </ul>

CONDITION	SUGGESTED SOLUTIONS
<b>Message appears on your computer screen:</b> <ul style="list-style-type: none"> <li>"Device can't be set to the H/W mode you want."</li> <li>"Port is being used by another program."</li> <li>"Port is Disabled."</li> <li>"Scanner is busy receiving or printing data. When the current job is completed, try again."</li> <li>"Invalid handle."</li> <li>"Scanning has failed."</li> </ul>	<ul style="list-style-type: none"> <li>There may be a copying or printing job in progress. Try your job again when that job is finished, try your job again.</li> <li>The selected port is currently being used. Restart your computer and try again.</li> <li>The printer cable may be improperly connected or the power may be off.</li> <li>The scanner driver is not installed or the operating environment is not set up properly.</li> <li>Ensure that the machine is properly connected and the power is on, then restart your computer.</li> <li>The USB cable may be improperly connected or the power may be off.</li> </ul>

## Fax problems

CONDITION	SUGGESTED SOLUTIONS
<b>The machine is not working, there is no display and the buttons are not working.</b>	<ul style="list-style-type: none"> <li>Unplug the power cord and plug it in again.</li> <li>Ensure that there is power being supplied to the electrical outlet.</li> </ul>
<b>No dial tone sounds.</b>	<ul style="list-style-type: none"> <li>Check that the phone line is properly connected.</li> <li>Check that the phone socket on the wall is working by plugging in another phone.</li> </ul>
<b>The numbers stored in memory do not dial correctly.</b>	Make sure that the numbers are stored in memory correctly. Print a <b>Fax Phone Book</b> list. (See "In the multi-purpose tray" on page96)
<b>The original does not feed into the machine.</b>	<ul style="list-style-type: none"> <li>Make sure that the paper is not wrinkled and you are inserting it in correctly. Check that the original is the right size, not too thick or thin.</li> <li>Make sure that the DADF is firmly closed.</li> <li>The DADF rubber pad may need to be replaced. Contact a service representative.</li> </ul>
<b>Faxes are not received automatically.</b>	<ul style="list-style-type: none"> <li>The receiving mode should be set to <b>Fax</b>.</li> <li>Make sure that there is paper in the tray.</li> <li>Check to see if the display shows any error message. If it does, clear the problem.</li> </ul>
<b>The machine does not send.</b>	<ul style="list-style-type: none"> <li>Make sure that the original is loaded in the DADF or on the scanner glass.</li> <li>Check the fax machine you are sending to, to see if it can receive your fax.</li> </ul>

CONDITION	SUGGESTED SOLUTIONS
The incoming fax has blank spaces or is of poor-quality.	<ul style="list-style-type: none"> <li>The fax machine sending you the fax may be faulty.</li> <li>A noisy phone line can cause line errors.</li> <li>Check your machine by making a copy.</li> <li>The toner cartridge may be empty. Replace the toner cartridge. (See "In the multi-purpose tray" on page96)</li> </ul>
Some of the words on an incoming fax are stretched.	The fax machine sending the fax had a temporary document jam.
There are lines on the originals you sent.	Check your scan unit for marks and clean it. (See "In the multi-purpose tray" on page96)
The machine dials a number, but the connection with the other fax machine fails.	The other fax machine may be turned off, out of paper, or cannot answer incoming calls. Speak with the other machine operator and ask her/him to solve out the problem.
Faxes do not store in memory.	There may not be enough memory space to store the fax. If the display shows the low <b>Fax memory is full. Print or remove received fax Job</b> message, delete any faxes you no longer need from the memory and then try to store the fax again. Please call for service.
Blank areas appear at the bottom of each page or on other pages, with a small strip of text at the top.	You may have chosen the wrong paper settings in the user option setting. For details about paper settings. (See "In the multi-purpose tray" on page96)

## Common PostScript problems

The following situations are PS language specific and may occur when several printer languages are being used.

 To receive a printed or screen-displayed message when PostScript errors occur, open the Print Options window and click the desired selection next to the PostScript errors section.

PROBLEM	POSSIBLE CAUSE	SOLUTION
PostScript file cannot be printed.	The PostScript driver may not be installed correctly.	<ul style="list-style-type: none"> <li>Install the PostScript driver, referring to <i>Software section</i>.</li> <li>Print a configuration page and verify that the PS version is available for printing.</li> <li>If the problem persists, contact a service representative.</li> </ul>
"Limit Check Error" message appears.	The print job was too complex.	You might need to reduce the complexity of the page or install more memory.

PROBLEM	POSSIBLE CAUSE	SOLUTION
A PostScript error page prints.	The print job may not be PostScript.	Make sure that the print job is a PostScript job. Check to see whether the software application expected a setup or PostScript header file to be sent to the machine.
The optional tray is not selected in the driver.	The printer driver has not been configured to recognize the optional tray.	Open the PostScript driver properties, select the <b>Device Settings</b> tab, and set the <b>Tray</b> option of the <b>Installable Options</b> section to <b>Installed</b> .
The machine does not staple correctly when printing more than one copy from Acrobat Reader with a collate option. (only in Window/Macintosh)	It might take longer to print when you print a PDF file as an image.	Try to print with the latest Adobe Reader program or print with turning on "Print as Image" option from Acrobat printing options. It might take longer to print when you print a PDF file as an image.
The machine does not staple correctly when printing more than one copy with a collate option. (only in Linux)	Turning off collation options on applications (including CUPS pstops collation option) may solve this problem.	If you want to use the collation option, go to printer driver's advanced option and turn the collation on.

## Common Windows problems

CONDITION	SUGGESTED SOLUTIONS
"File in Use" message appears during installation.	Exit all software applications. Remove all software from the StartUp Group, then restart Windows. Reinstall the printer driver.
"General Protection Fault", "Exception OE", "Spool32", or "Illegal Operation" messages appear.	Close all other applications, reboot Windows and try printing again.
"Fail To Print", "A printer timeout error occurred." messages appear.	These messages may appear during printing. Just keep waiting until the machine finishes printing. If the message appears in standby mode or after printing has been completed, check the connection and/or whether an error has occurred.

 Refer to Microsoft Windows User's Guide that came with your computer for further information on Windows error messages.



## Common Linux problems

CONDITION	SUGGESTED SOLUTIONS
<b>The machine does not print.</b>	<ul style="list-style-type: none"> <li>• Check if the printer driver is installed in your system. Open Unified Driver configurator and switch to the Printers tab in Printers configuration window to look at the list of available printers. Make sure that your machine is displayed on the list. If not, invoke Add new printer wizard to set up your device.</li> <li>• Check if the printer is started. Open Printers configuration and select your machine on the printers list. Look at the description in the Selected printer pane. If its status contains “(stopped)” string, press the <b>Start</b> button. After that normal operation of the printer should be restored. The “stopped” status might be activated when some problems in printing occurred. For instance, this could be an attempt to print document when port is claimed by a scanning application.</li> <li>• Check if the port is not busy. Since functional components of MFP (printer and scanner) share the same I/O interface (port), the situation of simultaneous access of different “consumer” application to the same port is possible. To avoid possible conflicts, only one of them at a time is allowed to gain control over the device. The other “consumer” will encounter “device busy” response. You should open ports configuration and select the port assigned to your printer. In the Selected port pane you can see if the port is occupied by some other application. If this is the case, you should wait for completion of the current job or should press Release port button, if you are sure that the present owner is not functioning properly.</li> <li>• Check if your application has special print option such as “-oraw”. If “-oraw” is specified in the command line parameter then remove it to print properly. For Gimp front-end, select “print” -&gt; “Setup printer” and edit command line parameter in the command item.</li> <li>• The CUPS (Common Unix Printing System) version distributed with SuSE Linux 9.2 (cups-1.1.21) has a problem with ipp (Internet Printing Protocol) printing. Use the socket printing instead of ipp or install later version of CUPS (cups-1.1.22 or higher).</li> </ul>
<b>Some color images come out all black.</b>	<p>This is a known bug in Ghostscript (until GNU Ghostscript version 7.05) when the base color space of the document is indexed color space and it is converted through CIE color space. Because Postscript uses CIE color space for Color Matching System, you should upgrade Ghostscript on your system to at least GNU Ghostscript version 7.06 or later. You can find recent Ghostscript versions at <a href="http://www.ghostscript.com">www.ghostscript.com</a>.</p>

CONDITION	SUGGESTED SOLUTIONS
<b>Some color images come out in unexpected color.</b>	<p>This is a known bug in Ghostscript (until GNU Ghostscript version 7.xx) when the base color space of the document is indexed RGB color space and it is converted through CIE color space. Because Postscript uses CIE color space for Color Matching System, you should upgrade Ghostscript on your system to at least GNU Ghostscript version 8.xx or later. You can find recent Ghostscript versions at <a href="http://www.ghostscript.com">www.ghostscript.com</a>.</p>
<b>The machine does not print whole pages and its output is half page printed.</b>	<p>It is a known problem that occurs when a color printer is used on version 8.51 or earlier of Ghostscript, 64-bit Linux OS, and reported to <a href="http://bugs.ghostscript.com">bugs.ghostscript.com</a> as Ghostscript Bug 688252.</p> <p>The problem is solved in AFPL Ghostscript v. 8.52 or above. Download the latest version of AFPL Ghostscript from <a href="http://sourceforge.net/projects/ghostscript/">http://sourceforge.net/projects/ghostscript/</a> and install it to solve this problem.</p>
<b>I cannot scan via Gimp Front-end.</b>	<ul style="list-style-type: none"> <li>• Check if Gimp Front-end has “Xsane: Device dialog.” on the “Acquire” menu. If not, you should install Xsane plug-in for Gimp on the your computer. You can find Xsane plug-in package for Gimp on Linux distribution CD or Gimp home page. For the detail information, refer to the Help for Linux distribution CD or Gimp Front-end application.</li> </ul> <p>If you wish to use other kind of scan application, refer to the Help for application.</p>
<b>I encounter error “Cannot open port device file” when printing a document.</b>	<p>Avoid changing print job parameters (via LPR GUI, for example) while a print job is in progress. Known versions of CUPS server break the print job whenever print options are changed and then try to restart the job from the beginning. Since Unified Linux Driver locks port while printing, the abrupt termination of the driver keeps the port locked and therefore unavailable for subsequent print jobs. If this situation occurred, try to release the port.</p>

CONDITION	SUGGESTED SOLUTIONS
<p><b>The machine does not appear on the scanners list.</b></p>	<ul style="list-style-type: none"> <li>• Check if your machine is attached to your computer. Make sure that it is connected properly via the USB port and is turned on.</li> <li>• Check if the scanner driver for your machine is installed in your system. Open Unified Driver configurator, switch to Scanners configuration, then press <b>Drivers</b>. Make sure that driver with a name corresponding to your machine's name is listed in the window. Check if the port is not busy. Since functional components of MFP (printer and scanner) share the same I/O interface (port), the situation of simultaneous access of different “consumer” application to the same port is possible. To avoid possible conflicts, only one of them at a time is allowed to gain control over the device. The other “consumer” will encounter “device busy” response. This can usually happen while starting scan procedure, and appropriate message box appears.</li> <li>• To identify the source of the problem, you should open ports configuration and select the port assigned to your scanner. port's symbol /dev/mfp0 corresponds to LP:0 designation displayed in the scanners' options, /dev/mfp1 relates to LP:1 and so on. USB ports start at /dev/mfp4, so scanner on USB:0 relates to /dev/mfp4 respectively and so forth sequentially. In the Selected port pane you can see if the port is occupied by some other application. If this is the case, you should wait for completion of the current job or should press Release port button, if you are sure that the present port's owner is not functioning properly.</li> </ul>

CONDITION	SUGGESTED SOLUTIONS
<p><b>The machine does not scan.</b></p>	<ul style="list-style-type: none"> <li>• Check if a document is loaded into the machine.</li> <li>• Check if your machine is connected to the computer. Make sure if it is connected properly if I/O error is reported while scanning.</li> <li>• Check if the port is not busy. Since functional components of MFP (printer and scanner) share the same I/O interface (port), the situation of simultaneous access of different “consumer” application to the same port is possible. To avoid possible conflicts, only one of them at a time is allowed to gain control over the device. The other “consumer” will encounter “device busy” response. This can usually happen while starting scan procedure, and appropriate message box will be displayed. To identify the source of the problem, you should open ports configuration and select the port assigned to your scanner. port's symbol /dev/mfp0 corresponds to LP:0 designation displayed in the scanners' options, /dev/mfp1 relates to LP:1 and so on. USB ports start at /dev/mfp4, so scanner on USB:0 relates to /dev/mfp4 respectively and so forth sequentially. In the Selected port pane you can see if the port is occupied by some other application. If this is the case, you should wait for completion of the current job or should press Release port button, if you are sure that the present port's owner is not functioning properly.</li> </ul>

 Refer to Linux User's Guide that came with your computer for further information on Linux error messages.

## Common Macintosh problems

CONDITION	SUGGESTED SOLUTIONS
<b>The printer does not print PDF file correctly. Some parts of graphics, text, or illustrations are missing.</b>	Incompatibility between the PDF file and the Acrobat products: Printing the PDF file as an image may solve this problem. Turn on <b>Print As Image</b> from the Acrobat printing options.  It will take longer to print when you print a PDF file as an image.
<b>The document has printed, but the print job has not disappeared from the spooler in Mac OS 10.3.2.</b>	Update your Mac OS to OS 10.3.3. or higher.
<b>Some letters are not displayed normally during the Cover page printing.</b>	This problem is caused because Mac OS cannot create the font during the Cover page printing. English alphabet and numbers are displayed normally at the Cover page.
<b>When printing a document in Macintosh with Acrobat Reader 6.0 or higher, colors print incorrectly.</b>	Make sure that the resolution setting in your printer driver matches the one in Acrobat Reader.

 Refer to Mac OS User's Guide that came with your computer for further information on Mac OS error messages.

# ordering supplies and accessories

This chapter provides information on purchasing cartridges and accessories available for your machine.

## This chapter includes:

- Supplies
- Accessories

 The optional parts or features may differ by countries. Contact your sales representatives whether the part you want is available in your country.

## SUPPLIES

When the toner cartridge or imaging unit runs out, you can order the following type of toner or imaging unit for your machine:

TYPE	AVERAGE YIELD <sup>a</sup>	PART NUMBER
<b>Toner cartridge<sup>a</sup></b>	Approx. 25,000	SCX-D6555A
<b>Imaging unit<sup>b</sup></b>	Approx. 80,000	SCX-R6555A

a. Declared yield value in accordance with ISO/IEC 19752.

b. Declared yield value is based on a single side of A4- or letter-sized paper.

 Depending on the options and job mode, the imaging unit's lifespan may differ.



 When purchasing new print cartridges or other supplies, these must be purchased in the same country where the machine was purchased. Otherwise, print cartridges or other supplies will be incompatible with your machine, as configurations of print cartridges and other supplies vary, depending on the specific country.

## ACCESSORIES

You can purchase and install accessories to enhance your machine's performance and capacity.

ACCESSORY	DESCRIPTION	PART NUMBER
<b>Memory module</b>	Extends your machine's memory capacity.	ML-MEM160: 256 MB  This machine comes with 256 MB DIMM. To expand the memory of your machine, you must remove the existing DIMM and purchase a larger one.

- How to purchase

ACCESSORY	DESCRIPTION	PART NUMBER
<b>Optional tray 2/3/4</b>	If you are experiencing paper supply problems frequently, you can attach an additional 520 sheet tray. You can print documents in various sizes and types of print materials.	SCX-S6555A
<b>High capacity feeder</b>	If you are frequently experiencing paper supply problems, you can attach an additional 2,100 sheet tray.	SCX-HCF100
<b>Fax option kit</b>	This kit lets you use your machine as a fax machine.	SCX-FAX210 <sup>a</sup>  After installing the kit, you have to set up your machine to activate this machine. (See Page 114)
<b>Stand</b>	You can place the machine on the ergonomically-designed cabinet which lets you reach the machine conveniently. Also, you can easily move the cabinet with its wheels, if necessary, and store miscellaneous items like papers into the cabinet.	<ul style="list-style-type: none"> <li>• Tall Stand: SCX-DSK10T</li> <li>• Short Stand: SCX-DSK10S</li> </ul>  If you do not use the optional tray then Tall Stand is recommended. In case you add three optional trays, use Short Stand.
<b>Stacker &amp; Stapler (Finisher)</b>	500 sheets	SCX-FIN10S
<b>Staple Cartridge</b>	3 x 5,000 staples per package, covers maximum thickness of 50 sheets, 1 staple position.	SCX-STP000
<b>SmarThru WorkFlow</b>	This feature lets you send additional information along with the scanned document to a specified network location.	SCX-KIT11S

ACCESSORY	DESCRIPTION	PART NUMBER
<b>FDI (Foreign Device Interface) kit</b>	This card is installed inside the machine to allow a third party device such as a coin operated device or a card reader. Those devices allow the pay-for-print service on your machine.	SCX-KIT10F
<b>4-Bin Mailbox</b>	You can load up to 100 sheets of paper in each stacker. To use 4-Bin Mailbox, you need to purchase and install 2-Bin Finisher first.	SCX-MBT40S
<b>2-Bin Finisher(Stacker &amp;Stapler)</b>	The 2-Bin Finisher consists of big size output tray which holds up to 500 sheets of paper and small size output tray which holds up to 100 sheets of paper.	SCX-FIN20S

a. Countries which supports the serial telephone system are Germany, Italia, France, Sweden, Denmark, Finland, Austria, Switzerland, Belgium, Hungary.

## HOW TO PURCHASE

To order Samsung-authorized supplies or accessories, contact your local Samsung dealer or the retailer where you purchased your machine, or visit [www.samsungprinter.com](http://www.samsungprinter.com) and select your country/region to obtain information on calling for technical support.

# installing accessories

Your machine is a full-featured model that has been optimized to meet most of your printing needs. Recognizing that each user may have different requirements, however, Samsung makes several accessories available to enhance your machine's capabilities.

## This chapter includes

- Precautions to take when installing accessories
- Installing a memory DIMM

## PRECAUTIONS TO TAKE WHEN INSTALLING ACCESSORIES

- Disconnect the power cord  
Never remove the control board cover while the power is turned on. To avoid the possibility of an electrical shock, always disconnect the power cord when installing or removing ANY internal or external accessories.
- Discharge static electricity  
The control board and internal accessories (network interface card or memory module) are sensitive to static electricity. Before installing or removing any internal accessories, discharge static electricity from your body by touching something metal, such as the metal back plate on any device plugged into a grounded power source. If you walk around before finishing the installation, repeat this procedure to discharge any static electricity again.

## INSTALLING A MEMORY DIMM

Your machine has a dual in-line memory module (DIMM) slot. Use this DIMM slot to install additional memory. Your machine has 256 MB of memory which can be expanded to 512 MB. The order information is provided for optional memory DIMM. (See "Memory module" on page 110.)

### Installing a memory module

1. Turn the machine off and unplug all cables from the machine.
2. Open the control board cover by grasping it and slide toward you.

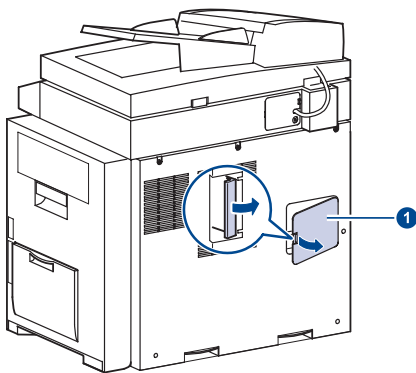

1 control board cover

3. Take out a new memory DIMM from the plastic bag.

- Replacing the Stapler
- Enabling Fax feature after installing the fax option kit

4. Holding the memory module by the edges, align the memory module on the slot at about a 30-degree tilt. Make sure that the notches of the module and the grooves on the slot fit each other.

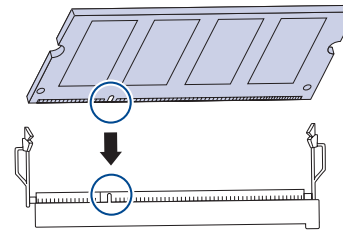

- ☞ The notches and grooves illustrated above may not match those on an actual DIMM and its slot.

5. Press the memory module into the slot with care until you hear a "click".

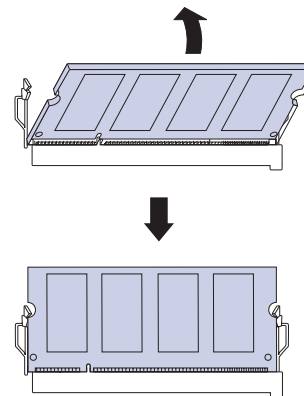

- ☞ Do not press the memory module strongly or the module may be damaged. If the module does not seem to fit into the slot properly, carefully try the previous procedure again.



6. Replace the control board cover.

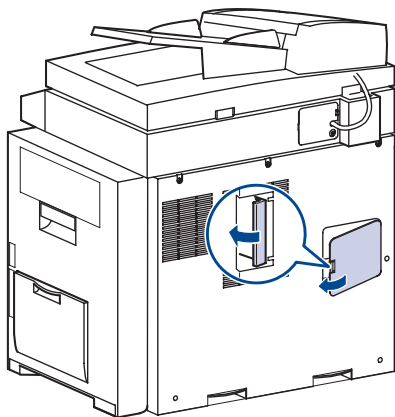

7. Reconnect the power cord and printer cable, and turn the machine on.

### Activating the added memory in the PS printer properties

After installing the memory module, you need to select it in the printer properties of the PostScript printer driver in order to use it.

1. Make sure that the PostScript printer driver is installed on your computer. For details about installing the PS printer driver, see *Software section*.
2. Click the Windows **Start** menu.
3. For Windows 2000, select **Settings** and then **Printers**.  
For Windows XP/2003, select **Printers and Faxes**.  
For Windows /2008, select **Control Panel > Hardware and Sound > Printers**.  
For Windows 7, select **Control Panel > Hardware and Sound > Devices and Printers**.  
For Windows Server 2008 R2, select **Control Panel > Hardware > Devices and Printers**.
4. Select the **Samsung SCX-6x55X Series PS** printer.
5. Click the right mouse button on the printer icon and select **Properties**.
6. Select **Device Settings**.
7. Select the amount of memory you installed from **Printer Memory** in the **Installable Options** section.
8. Click **OK**.

## REPLACING THE STAPLER

When the stapler is completely empty, the message for installing the staple cartridge appears on the display screen.

1. Open the finisher cover.

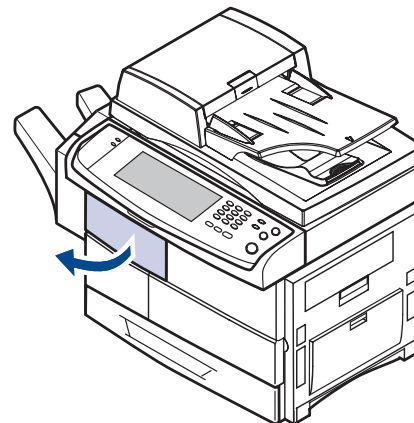

2. Pull the stapler unit out.

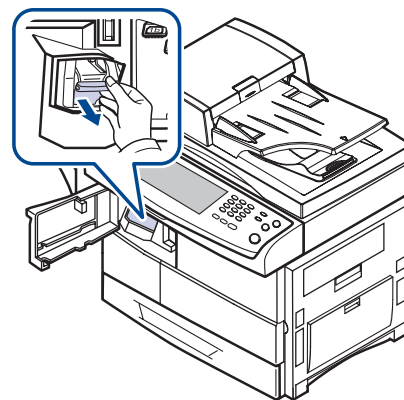

3. Lift the empty staple cartridge from the stapler unit.

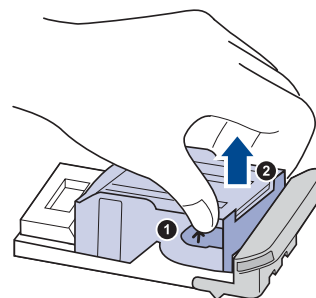

4. Unpack the new staple cartridge.
5. Place the staple cartridge back into the stapler unit.

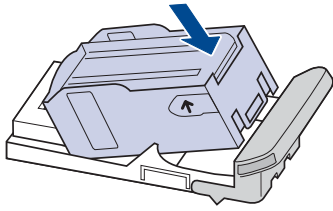

6. Slide the stapler unit in until it locks in place.

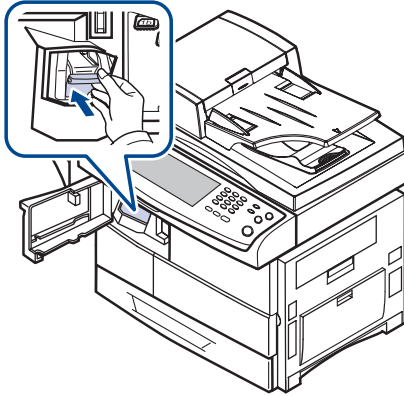

7. Close the finisher cover.

## ENABLING FAX FEATURE AFTER INSTALLING THE FAX OPTION KIT

After installing the Fax kit, you have to set up the machine in order to use this function.

1. Press **Machine Setup** on the control panel.
2. Press **Admin Setting**.
3. When the login message appears, enter password with number keypad and press **OK**. (See "Setting the authentication password" on page 30.)
4. Press the **General** tab.
5. Press **Country**.  
Change the country, then some the values for fax and paper size will be changed automatically for your country.

# specifications

This chapter guides you about this machine's specifications such as various features.

## This chapter includes;

- General specifications
- Printer specifications
- Copier specifications
- Scanner specifications
- Facsimile specifications (optional)

## GENERAL SPECIFICATIONS

Item	Description
<b>DADF</b>	Up to 100 sheets 75 g/m <sup>2</sup> (20 lb bond)
<b>DADF document size</b>	<ul style="list-style-type: none"> <li>• Width: 148.5 to 218 mm</li> <li>• Length: 145 to 356 mm</li> </ul>
<b>Paper input capacity</b>	<ul style="list-style-type: none"> <li>• Tray 1: 520 multi-page for plain paper (75 g/m<sup>2</sup>)</li> <li>• Multi-purpose tray: 100 multi-page for plain paper (75 g/m<sup>2</sup>)</li> <li>• optional tray 2/3/4: 520 multi-page for plain paper (75 g/m<sup>2</sup>)</li> <li>• optional high capacity feeder: 2,100 multi-page for plain paper (75 g/m<sup>2</sup>)</li> </ul> <p>For details about paper input capacity, see "Specification on print media" on page 35.</p>
<b>Paper output capacity</b>	<ul style="list-style-type: none"> <li>• Face down: 500 sheets 75 g/m<sup>2</sup> (20 lb bond)</li> <li>• Optional stacker: 500 sheets 75 g/m<sup>2</sup> (20 lb bond)</li> </ul>
<b>Consumables</b>	2-piece toner cartridge and imaging unit system
<b>Power rating</b>	110 - 127 VAC, or 220 - 240 VAC See the Rating label on the machine for the correct voltage, frequency (hertz) and type of current for your machine.
<b>Power consumption</b>	<ul style="list-style-type: none"> <li>• Average operation mode: Less than 750 W</li> <li>• Power save mode: Less than 25 W</li> <li>• Stand by mode: Less than 120 W</li> </ul>
<b>Noise level<sup>a</sup></b>	<ul style="list-style-type: none"> <li>• Standby mode: Less than 30 dBA</li> <li>• Printing mode: Less than 55 dBA</li> <li>• Copying mode: Less than 57 dBA</li> </ul>
<b>Boot-up time</b>	Less than 35 seconds (from sleep mode) The boot-up time will be longer, if data volume is a lot in the HDD
<b>Operating environment</b>	Temperature: 10 °C to 32 °C Humidity: 20% to 80% RH
<b>Display</b>	wVGA (800 x 480 x RGV) color
<b>Toner cartridge yield<sup>b</sup></b>	Average Cartridge Yield 25,000 standard pages. Declared yield value in accordance with ISO/IEC 19752.

Item	Description
<b>Imaging unit yield<sup>c</sup></b>	Approx. 80,000 pages
<b>Memory</b>	256 MB (max. 512 MB)
<b>External dimension (W x D x H)</b>	633 x 506 x 641 mm (24.92 x 19.92 x 25.23 inches) without optional trays
<b>Weight</b>	44.85 Kg (including consumables)
<b>Package weight</b>	Paper: 5.4 Kg, Plastic: 1.2 Kg

- a. Sound Pressure Level, ISO 7779  
b. Average cartridge yield declared in accordance with ISO/IEC 19752.  
The number of pages may be affected by the operating environment, printing interval, media type, and media size.  
c. May be affected by operating environment, optional, printing interval, media type and media size.

## PRINTER SPECIFICATIONS

Item	Description
<b>Printing method</b>	Laser Beam Printing
<b>Printing speed<sup>a</sup></b>	Up to 53 ppm in A4 (55 ppm in Letter)
<b>Duplex printing speed</b>	Up to 50 ipm in A4 (52 ipm in Letter)
<b>First print out time</b>	8 seconds (from ready)
<b>Print resolution</b>	Up to 1,200 x 1,200 dpi Effective output
<b>Printer language</b>	PCL 6, PS 3, PDF Direct V1.4, TIFF, JPEG
<b>OS compatibility<sup>b</sup></b>	<ul style="list-style-type: none"> <li>• PCL Driver: Windows 2000/XP/2003/2008//7/ Server 2008 R2</li> <li>• PS Driver: Windows 2000/XP/2003/2008//7/ Server 2008 R2, Various Linux OS, Mac OS 10.3 ~ 10.6</li> </ul>
<b>Interface</b>	High Speed USB 2.0 Device x1, High Speed USB 2.0 HOST Ethernet 10/100/1000 Base TX

- a. Print speed will be affected by operating system used, computing performance, application software, connect on method, media type, media size, and job complexity.
- b. Please visit [www.samsungprinter.com](http://www.samsungprinter.com) to download the latest software version.

## COPIER SPECIFICATIONS

Item	Description
<b>Copy speed<sup>a</sup></b>	Up to 53 ppm in A4 (55 ppm in Letter)
<b>Duplex copy speed</b>	<ul style="list-style-type: none"> <li>• Simplex to Duplex (1-2): Up to 50 ipm in A4 (52 ipm in Letter)</li> <li>• Duplex to Duplex (2-2): Up to 35 ipm in A4 (37 ipm in Letter)</li> </ul>
<b>First copy out time</b>	<ul style="list-style-type: none"> <li>• Scanner glass: Less than 5 seconds</li> <li>• DADF: Less than 8 seconds</li> </ul>
<b>Copy resolution</b>	<ul style="list-style-type: none"> <li>• Scan: up to 600 x 300 (text, text/photo), up to 600 x 600 (photo)</li> <li>• Print: up to 600 x 600 (text, text/photo), up to 1,200 x 1,200 (photo)</li> </ul>
<b>Zoom rate</b>	<ul style="list-style-type: none"> <li>• Scanner glass: 25 to 400%</li> <li>• DADF: 25 to 200%</li> </ul>
<b>Multiple copies</b>	1 to 999 pages

a. Copy speed is based on single document multiple copy.

## SCANNER SPECIFICATIONS

Item	Description
<b>Compatibility</b>	TWAIN standard / WIA standard
<b>Scanning method</b>	DADF and Flat-bed Color CCD (Charge Coupled Device) module
<b>Resolution<sup>a</sup></b>	TWAIN standard: 1,200 x 1,200 dpi (Up to 4,800 x 4,800 dpi by software enhancement) WIA standard: Up to 600 x 600 dpi Scan to USB, Scan to PC: 100, 200, 300 dpi Scan to E-mail, Scan to Server: 100, 200, 300, 400, 600 dpi
<b>Network Scan File format</b>	PDF, TIFF, JPEG <sup>b</sup>
<b>Effective scanning length</b>	<ul style="list-style-type: none"> <li>• Scanner glass: 348 mm (13.7 inches)</li> <li>• DADF: 348 mm (13.7 inches)</li> </ul>
<b>Effective scanning width</b>	Max. 208 mm (8.2 inches)

Item	Description
<b>Color bit depth</b>	<ul style="list-style-type: none"> <li>• Internal: 36 bits</li> <li>• External: 24 bits</li> </ul>
<b>Mono bit depth</b>	1 bit for Linearity & Halftone 8 bits (External), 12 bits (Internal) for Gray scale
<b>Grayscale</b>	256 levels

- a. Due to the applications for scanning, the maximum resolution might differ.
- b. JPEG is not available when you select the mono mode in Color Mode.

## FACSIMILE SPECIFICATIONS (OPTIONAL)

Item	Description
<b>Compatibility</b>	ITU-T G3, Super G3
<b>Applicable line</b>	Public Switched Telephone Network (PSTN) or behind PABX
<b>Data coding</b>	MH/MR/MMR/JBIG/JPEG (Tx only)
<b>Modem speed</b>	33.6 Kbps
<b>Transmission speed</b>	Up to 3 seconds/page <sup>a</sup>
<b>Maximum document length</b>	<ul style="list-style-type: none"> <li>• Scanner glass: 356 mm (14 inches)</li> <li>• Duplex automatic document glass: 356 mm (14 inches)</li> </ul>
<b>Resolution</b>	<ul style="list-style-type: none"> <li>• Standard: 203 x 98 dpi</li> <li>• Fine: 203 x 196 dpi</li> <li>• Super Fine: 300 x 300 dpi, 406 x 392 dpi, 203 x 392 dpi (Rx<sup>b</sup> only)</li> </ul>
<b>Memory</b>	16 MB
<b>Halftone</b>	256 levels
<b>Auto dialer</b>	up to 200 numbers

- a. Standard resolution, MMR(JBIG), Maximum modem speed, Phase"C" by ITU-T No.1 chart, Memory Tx, ECM.
- b. Rx stands for receiving a fax.

# glossary

---

 The following glossary helps you get familiar with the product by understanding the terminologies commonly used with printing as well as mentioned in this user's guide.

## **ADF**

An Automatic Document Feeder (ADF) is a mechanism that will automatically feed an original sheet of paper so that the machine can scan some amount of the paper at once.

## **AppleTalk**

AppleTalk is a proprietary suite of protocols developed by Apple, Inc for computer networking. It was included in the original Macintosh (1984) and is now deprecated by Apple in favor of TCP/IP networking.

## **BIT Depth**

A computer graphics term describing the number of bits used to represent the color of a single pixel in a bitmapped image. Higher color depth gives a broader range of distinct colors. As the number of bits increases, the number of possible colors becomes impractically large for a color map. 1-bit color is commonly called as monochrome or black and white.

## **BMP**

A bitmapped graphics format used internally by the Microsoft Windows graphics subsystem (GDI), and used commonly as a simple graphics file format on that platform.

## **BOOTP**

Bootstrap Protocol. A network protocol used by a network client to obtain its IP address automatically. This is usually done in the bootstrap process of computers or operating systems running on them. The BOOTP servers assign the IP address from a pool of addresses to each client. BOOTP enables 'diskless workstation' computers to obtain an IP address prior to loading any advanced operating system.

## **CCD**

Charge Coupled Device (CCD) is a hardware which enables the scan job. CCD Locking mechanism is also used to hold the CCD module to prevent any damage when you move the machine.

## **Collation**

Collation is a process of printing a multiple-copy job in sets. When collation is selected, the device prints an entire set before printing additional copies.

## **Control Panel**

A control panel is a flat, typically vertical, area where control or monitoring instruments are displayed. They are typically found in front of the machine.

## **Coverage**

It is the printing term used for a toner usage measurement on printing. For example, 5% coverage means that an A4 sided paper has about 5% image or text on it. So, if the paper or original has complicated images or lots of text on it, the coverage will be higher and at the same time, a toner usage will be as much as the coverage.

## **CSV**

Comma Separated Values (CSV). A type of file format, CSV is used to exchange data between disparate applications. The file format, as it is used in Microsoft Excel, has become a pseudo standard throughout the industry, even among non-Microsoft platforms.

## **DADF**

A Duplex Automatic Document Feeder (DADF) is a mechanism that will automatically feed and flip over an original sheet of paper so that the machine can scan on both sides of the paper.

## **Default**

The value or setting that is in effect when taking a printer out of its box state, reset, or initialized.

## **DHCP**

A Dynamic Host Configuration Protocol (DHCP) is a client-server networking protocol. A DHCP server provides configuration parameters specific to the DHCP client host requesting, generally, information required by the client host to participate on an IP network. DHCP also provides a mechanism for allocation of IP addresses to client hosts.

## **DIMM**

Dual Inline Memory Module (DIMM), a small circuit board that holds memory. DIMM stores all the data within the machine like printing data, received fax data.

## **DNS**

The Domain Name Server (DNS) is a system that stores information associated with domain names in a distributed database on networks, such as the Internet.

## **Dot Matrix Printer**

A dot matrix printer refers to a type of computer printer with a print head that runs back and forth on the page and prints by impact, striking an ink-soaked cloth ribbon against the paper, much like a typewriter.

## **DPI**

Dots Per Inch (DPI) is a measurement of resolution that is used for scanning and printing. Generally, higher DPI results in a higher resolution, more visible detail in the image, and a larger file size.

## **DRPD**

Distinctive Ring Pattern Detection. Distinctive Ring is a telephone company service which enables a user to use a single telephone line to answer several different telephone numbers.

## **Duplex**

A mechanism that will automatically flip over a sheet of paper so that the machine can print (or scan) on both sides of the paper. A printer equipped with a Duplex can print double-sided of paper.

## **Duty Cycle**

Duty cycle is the page quantity which does not affect printer performance for a month. Generally the printer has the lifespan limitation such as pages per year. The lifespan means the average capacity of print-outs, usually within the warranty period. For example, if the duty cycle is 48,000 pages per month assuming 20 working days, a printer limits 2,400 pages a day.

## **ECM**

Error Correction Mode (ECM) is an optional transmission mode built into Class 1 fax machines or fax modems. It automatically detects and corrects errors in the fax transmission process that are sometimes caused by telephone line noise.

## **Emulation**

Emulation is a technique of one machine obtaining the same results as another.



An emulator duplicates the functions of one system with a different system, so that the second system behaves like the first system. Emulation focuses on exact reproduction of external behavior, which is in contrast to simulation, which concerns an abstract model of the system being simulated, often considering its internal state.

## **Ethernet**

Ethernet is a frame-based computer networking technology for local area networks (LANs). It defines wiring and signaling for the physical layer, and frame formats and protocols for the media access control (MAC)/data link layer of the OSI model. Ethernet is mostly standardized as IEEE 802.3. It has become the most widespread LAN technology in use during the 1990s to the present.

## **EtherTalk**

A suite of protocols developed by Apple Computer for computer networking. It was included in the original Macintosh (1984) and is now deprecated by Apple in favor of TCP/IP networking.

## **FDI**

Foreign Device Interface (FDI) is a card installed inside the machine to allow a third party device such as a coin operated device or a card reader. Those devices allow the pay-for-print service on your machine.

## **FTP**

A File Transfer Protocol (FTP) is a commonly used protocol for exchanging files over any network that supports the TCP/IP protocol (such as the Internet or an intranet).

## **Fuser Unit**

The part of a laser printer that melts the toner onto the print media. It consists of a hot roller and a back-up roller. After toner is transferred onto the paper, the fuser unit applies heat and pressure to ensure that the toner stays on the paper permanently, which is why paper is warm when it comes out of a laser printer.

## **Gateway**

A connection between computer networks, or between a computer network and a telephone line. It is very popular, as it is a computer or a network that allows access to another computer or network.

## **Grayscale**

A shades of gray that represent light and dark portions of an image when color images are converted to grayscale; colors are represented by various shades of gray.

## **Halftone**

An image type that simulates grayscale by varying the number of dots. Highly colored areas consist of a large number of dots, while lighter areas consist of a smaller number of dots.

## **HDD**

Hard Disk Drive (HDD), commonly referred to as a hard drive or hard disk, is a non-volatile storage device which stores digitally-encoded data on rapidly rotating platters with magnetic surfaces.

## **IEEE**

The Institute of Electrical and Electronics Engineers (IEEE) is an international non-profit, professional organization for the advancement of technology related to electricity.

## **IEEE 1284**

The 1284 parallel port standard was developed by the Institute of Electrical and Electronics Engineers (IEEE). The term "1284-B" refers to a specific connector type on the end of the parallel cable that attaches to the peripheral (for example, a printer).

## **Intranet**

A private network that uses Internet Protocols, network connectivity, and possibly the public telecommunication system to securely share part of an organization's information or operations with its employees. Sometimes the term refers only to the most visible service, the internal website.

## **IP address**

An Internet Protocol (IP) address is a unique number that devices use in order to identify and communicate with each other on a network utilizing the Internet Protocol standard.

## **IPM**

The Images Per Minute (IPM) is a way of measuring the speed of a printer. An IPM rate indicates the number of single-sided sheets a printer can complete within one minute.

## **IPP**

The Internet Printing Protocol (IPP) defines a standard protocol for printing as well as managing print jobs, media size, resolution, and so forth. IPP can be used locally or over the Internet to hundreds of printers, and also supports access control, authentication, and encryption, making it a much more capable and secure printing solution than older ones.

## **IPX/SPX**

IPX/SPX stands for Internet Packet Exchange/Sequenced Packet Exchange. It is a networking protocol used by the Novell NetWare operating systems. IPX and SPX both provide connection services similar to TCP/IP, with the IPX protocol having similarities to IP, and SPX having similarities to TCP. IPX/SPX was primarily designed for local area networks (LANs), and is a very efficient protocol for this purpose (typically its performance exceeds that of TCP/IP on a LAN).

## **ISO**

The International Organization for Standardization (ISO) is an international standard-setting body composed of representatives from national standards bodies. It produces world-wide industrial and commercial standards.

## **ITU-T**

The International Telecommunication Union is an international organization established to standardize and regulate international radio and telecommunications. Its main tasks include standardization, allocation of the radio spectrum, and organizing interconnection arrangements between different countries to allow international phone calls. A -T out of ITU-T indicates telecommunication.

## **ITU-T No. 1 chart**

Standardized test chart published by ITU-T for document facsimile transmissions.

## **JBIG**

Joint Bi-level Image Experts Group (JBIG) is an image compression standard with no loss of accuracy or quality, which was designed for compression of binary images, particularly for faxes, but can also be used on other images.

## **JPEG**

Joint Photographic Experts Group (JPEG) is a most commonly used standard method of lossy compression for photographic images. It is the format used for storing and transmitting photographs on the World Wide Web.

## **LDAP**

The Lightweight Directory Access Protocol (LDAP) is a networking protocol for querying and modifying directory services running over TCP/IP.



## **LED**

LED

A Light-Emitting Diode (LED) is a semiconductor device that indicates the status of a machine.

## **MAC address**

Media Access Control (MAC) address is a unique identifier associated with a network adapter. MAC address is a unique 48-bit identifier usually written as 12 hexadecimal characters grouped in pairs (e. g., 00-00-0c-34-11-4e). This address is usually hard-coded into a Network Interface Card (NIC) by its manufacturer, and used as an aid for routers trying to locate machines on large networks.

## **MFP**

Multi Function Peripheral (MFP) is an office machine that includes the following functionality in one physical body, so as to have a printer, a copier, a fax, a scanner and etc.

## **MH**

Modified Huffman (MH) is a compression method for decreasing the amount of data that needs to be transmitted between the fax machines to transfer the image recommended by ITU-T T.4. MH is a codebook-based run-length encoding scheme optimized to efficiently compress white space. As most faxes consist mostly of white space, this minimizes the transmission time of most faxes.

## **MMR**

Modified Modified READ (MMR) is a compression method recommended by ITU-T T.6.

## **Modem**

A device that modulates a carrier signal to encode digital information, and also demodulates such a carrier signal to decode transmitted information.

## **MR**

Modified Read (MR) is a compression method recommended by ITU-T T.4. MR encodes the first scanned line using MH. The next line is compared to the first, the differences determined, and then the differences are encoded and transmitted.

## **NetWare**

A network operating system developed by Novell, Inc. It initially used cooperative multitasking to run various services on a PC, and the network protocols were based on the archetypal Xerox XNS stack. Today NetWare supports TCP/IP as well as IPX/SPX.

## **OPC**

Organic Photo Conductor (OPC) is a mechanism that makes a virtual image for print using a laser beam emitted from a laser printer, and it is usually green or gray colored and a cylinder shaped.

An exposing unit of a imaging is slowly worn away by its usage of the printer, and it should be replaced appropriately since it gets scratches from grits of a paper.

## **Originals**

The first example of something, such as a document, photograph or text, etc, which is copied, reproduced or translated to produce others, but which is not itself copied or derived from something else.

## **OSI**

Open Systems Interconnection (OSI) is a model developed by the International Organization for Standardization (ISO) for communications. OSI offers a standard, modular approach to network design that divides the required set of complex functions into manageable, self-contained, functional layers. The layers are, from top to bottom, Application, Presentation, Session, Transport, Network, Data Link and Physical.

## **PABX**

A private automatic branch exchange (PABX) is an automatic telephone switching system within a private enterprise.

## **PCL**

Printer Command Language (PCL) is a Page Description Language (PDL) developed by HP as a printer protocol and has become an industry standard. Originally developed for early inkjet printers, PCL has been released in varying levels for thermal, matrix printer, and page printers.

## **PDF**

Portable Document Format (PDF) is a proprietary file format developed by Adobe Systems for representing two dimensional documents in a device independent and resolution independent format.

## **PostScript**

PostScript (PS) is a page description language and programming language used primarily in the electronic and desktop publishing areas. - that is run in an interpreter to generate an image.

## **Printer Driver**

A program used to send commands and transfer data from the computer to the printer.

## **Print Media**

The media like paper, envelopes, labels, and transparencies which can be used on a printer, a scanner, a fax or, a copier.

## **PPM**

Pages Per Minute (PPM) is a method of measurement for determining how fast a printer works, meaning the number of pages a printer can produce in one minute.

## **PRN file**

An interface for a device driver, this allows software to interact with the device driver using standard input/output system calls, which simplifies many tasks.

## **Protocol**

A convention or standard that controls or enables the connection, communication, and data transfer between two computing endpoints.

## **PS**

See PostScript.

## **PSTN**

The Public-Switched Telephone Network (PSTN) is the network of the world's public circuit-switched telephone networks which, on industrial premises, is usually routed through the switchboard.

## **Resolution**

The sharpness of an image, measured in Dots Per Inch (DPI). The higher the dpi, the greater the resolution.

## **SMB**

Server Message Block (SMB) is a network protocol mainly applied to share files, printers, serial ports, and miscellaneous communications between nodes on a network. It also provides an authenticated Inter-process communication mechanism.

## **SMTP**

Simple Mail Transfer Protocol (SMTP) is the standard for e-mail transmissions across the Internet. SMTP is a relatively simple, text-based protocol, where one or more recipients of a message are specified, and then the message text is transferred. It is a client-server protocol, where the client transmits an email message to the server.

## **Subnet Mask**

The subnet mask is used in conjunction with the network address to determine which part of the address is the network address and which part is the host address.

## **TCP/IP**

The Transmission Control Protocol (TCP) and the Internet Protocol (IP); the set of communications protocols that implement the protocol stack on which the Internet and most commercial networks run.

## **TCR**

Transmission Confirmation Report (TCR) provides details of each transmission such as job status, transmission result and number of pages sent. This report can be set to print after each job or only after failed transmissions.

## **TIFF**

Tagged Image File Format (TIFF) is a variable-resolution bitmapped image format. TIFF describes image data that typically come from scanners. TIFF images make use of tags, keywords defining the characteristics of the image that is included in the file. This flexible and platform-independent format can be used for pictures that have been made by various image processing applications.

## **Toner Cartridge**

A kind of bottle within a machine like printer which contains toner. Toner is a powder used in laser printers and photocopiers, which forms the text and images on the printed paper. Toner can be melted by the heat of the fuser, causing it to bind to the fibers in the paper.

## **TWAIN**

An industry standard for scanners and software. By using a TWAIN-compliant scanner with a TWAIN-compliant program, a scan can be initiated from within the program.; an image capture API for Microsoft Windows and Apple Macintosh operating systems.

## **UNC Path**

Uniform Naming Convention (UNC) is a standard way to access network shares in Window NT and other Microsoft products. The format of a UNC path is: \\<servername>\<sharename>\<Additional directory>

## **URL**

Uniform Resource Locator (URL) is the global address of documents and resources on the Internet. The first part of the address indicates what protocol to use, the second part specifies the IP address or the domain name where the resource is located.

## **USB**

Universal Serial Bus (USB) is a standard that was developed by the USB Implementers Forum, Inc., to connect computers and peripherals. Unlike the parallel port, USB is designed to concurrently connect a single computer USB port to multiple peripherals.

## **Watermark**

A watermark is a recognizable image or pattern in paper that appears lighter when viewed by transmitted light. Watermarks were first introduced in Bologna, Italy in 1282; they have been used by papermakers to identify their product, and also on postage stamps, currency, and other government documents to discourage counterfeiting.

## **WIA**

Windows Imaging Architecture (WIA) is an imaging architecture that is originally introduced in Windows Me and Windows XP. A scan can be initiated from within these operating systems by using a WIA-compliant scanner.

# contact samsung worldwide

If you have any comments or questions regarding Samsung products, contact the Samsung customer care center.

COUNTRY/REGION	CUSTOMER CARE CENTER	WEB SITE
ARGENTINE	0800-333-3733	www.samsung.com
ARMENIA	0-800-05-555	
AUSTRALIA	1300 362 603	www.samsung.com
AUSTRIA	0810-SAMSUNG (7267864, € 0.07/min)	www.samsung.com
AZERBAIJAN	088-55-55-555	
BAHRAIN	8000-4726	
BELARUS	810-800-500-55-500	www.samsung.ua www.samsung.com/ua_ru
BELGIUM	02-201-24-18	www.samsung.com/be (Dutch) www.samsung.com/be_fr (French)
BRAZIL	0800-124-421 4004-0000	www.samsung.com
CANADA	1-800-SAMSUNG (726-7864)	www.samsung.com
CHILE	800-SAMSUNG (726-7864)	www.samsung.com
CHINA	400-810-5858 010-6475 1880	www.samsung.com
COLOMBIA	01-8000112112	www.samsung.com
COSTA RICA	0-800-507-7267	www.samsung.com
CZECH REPUBLIC	800-SAMSUNG (800-726786) Samsung Zrt., česká organizační složka, Oasis Florenc, Sokolovská394/17, 180 00, Praha 8	www.samsung.com
DENMARK	70 70 19 70	www.samsung.com
ECUADOR	1-800-10-7267	www.samsung.com
EGYPT	0800-726786	
EIRE	0818 717100	www.samsung.com
EL SALVADOR	800-6225	www.samsung.com
ESTONIA	800-7267	www.samsung.com
KAZAKHSTAN	8-10-800-500-55-500	www.samsung.com/kz_ru
KYRGYZSTAN	00-800-500-55-500	
FINLAND	030-6227 515	www.samsung.com
FRANCE	01 48 63 00 00	www.samsung.com

COUNTRY/REGION	CUSTOMER CARE CENTER	WEB SITE
GERMANY	01805 - SAMSUNG (726-7864 € 0,14/min)	www.samsung.com
GEORGIA	8-800-555-555	
GUATEMALA	1-800-299-0013	www.samsung.com
HONDURAS	800-7919267	www.samsung.com
HONG KONG	(852) 3698-4698	www.samsung.com/hk www.samsung.com/hk_en/
HUNGARY	06-80-SAMSUNG (726-7864)	www.samsung.com
INDIA	3030 8282 1800 110011 1800 3000 8282 1800 266 8282	www.samsung.com
INDONESIA	0800-112-8888 021-5699-7777	www.samsung.com
ITALIA	800-SAMSUNG (726-7864)	www.samsung.com
JAMAICA	1-800-234-7267	www.samsung.com
JAPAN	0120-327-527	www.samsung.com
JORDAN	800-22273	
KSA	9200-21230	www.samsung.com
BAHRAIN	8000-4726	
LATVIA	8000-7267	www.samsung.com
LITHUANIA	8-800-77777	www.samsung.com
LUXEMBURG	261 03 710	www.samsung.com
MALAYSIA	1800-88-9999	www.samsung.com
MEXICO	01-800-SAMSUNG (726-7864)	www.samsung.com
MOLDOVA	00-800-500-55-500	www.samsung.ua www.samsung.com/ua_ru
NETHERLANDS	0900-SAMSUNG (0900-7267864) (€ 0,10/min)	www.samsung.com
NEW ZEALAND	0800 SAMSUNG (0800 726 786)	www.samsung.com
NICARAGUA	00-1800-5077267	www.samsung.com
NORWAY	815-56 480	www.samsung.com
PANAMA	800-7267	www.samsung.com

COUNTRY/REGION	CUSTOMER CARE CENTER	WEB SITE
<b>PHILIPPINES</b>	1800-10-SAMSUNG (726-7864) 1-800-3-SAMSUNG (726-7864) 1-800-8-SAMSUNG (726-7864) 02-5805777	www.samsung.com
<b>POLAND</b>	0 801 1SAMSUNG (172678) 022-607-93-33	www.samsung.com
<b>PORTUGAL</b>	80820-SAMSUNG (726-7864)	www.samsung.com
<b>PUERTO RICO</b>	1-800-682-3180	www.samsung.com
<b>QATAR</b>	800-2255	
<b>REP. DOMINICA</b>	1-800-751-2676	www.samsung.com
<b>RUSSIA</b>	8-800-555-55-55	www.samsung.ru
<b>SINGAPORE</b>	1800-SAMSUNG (726-7864)	www.samsung.com
<b>SLOVAKIA</b>	0800-SAMSUNG (726-7864)	www.samsung.com
<b>SOUTH AFRICA</b>	0860 SAMSUNG (726-7864)	www.samsung.com
<b>SPAIN</b>	902-1-SAMSUNG(902 172 678)	www.samsung.com
<b>SWEDEN</b>	0771 726 7864 (SAMSUNG)	www.samsung.com
<b>SWITZERLAND</b>	0848-SAMSUNG (7267864, CHF 0.08/min)	www.samsung.com
<b>SYRIA</b>	1825-22-73	
<b>TADJIKISTAN</b>	8-10-800-500-55-500	
<b>TAIWAN</b>	0800-329-999	www.samsung.com
<b>THAILAND</b>	1800-29-3232 02-689-3232	www.samsung.com
<b>TRINIDAD &amp; TOBAGO</b>	1-800-SAMSUNG (726-7864)	www.samsung.com
<b>TURKEY</b>	444 77 11	www.samsung.com
<b>U.A.E</b>	800-SAMSUNG (726-7864)	www.samsung.com
<b>U.K</b>	0845 SAMSUNG (726-7864)	www.samsung.com
<b>U.S.A</b>	1-800-SAMSUNG (726-7864)	www.samsung.com
<b>UKRAINE</b>	8-800-502-000	www.samsung.ua www.samsung.com/ua_ru

COUNTRY/REGION	CUSTOMER CARE CENTER	WEB SITE
<b>UZBEKISTAN</b>	8-10-800-500-55-500	www.samsung.com/kz_ru
<b>VENEZUELA</b>	0-800-100-5303	www.samsung.com
<b>VIETNAM</b>	1 800 588 889	www.samsung.com

## A

- ADF, load 33
- adjustment
  - altitude 29
- admin setting 75
- altitude adjustment 77
- answering machine/fax 63
- authentication
  - network accounting 80
  - printing a report 76, 82
  - setting up 30, 76
- auto center 48

## B

- Book copy 46

## C

- checking stored document 84
- cleaning
  - inside 84
  - outside 84
  - scan unit 84
  - transfer unit 84
- Clone copy 46
- collated 44
- color mode
  - faxing 64
  - scanning 57, 72
- control panel 18, 19
- copy
  - copying 42
  - covers 47
  - duplex copy 43
  - erasing background 47
  - erasing edge 47
  - ID stamp 78
  - making a booklet 46
  - page number 78
  - poster 45
  - reduce/enlarge 43
  - shifting margin 47
  - solving copy problems 104
  - text/photo 44
  - the size of the originals 42
  - time & date 78
  - transparencies 47

- copy setup 78

## D

- DADF
  - cover 18
  - input tray 18
  - output tray 18
  - width guides 18
- darkness
  - copying 44
  - faxing 64
  - scanning 57, 73
- date & time 30, 76
  - printing date&time in copied out 76, 78
- default settings 31
  - altitude adjustment 77
  - changing the default settings 31
  - energy saver 77
  - language 76
  - loading paper 30
  - machine test 77
  - measurements 76
  - output option 77
  - setting a fax header 61
  - sound 77
  - supplies management 77
  - system timeout 76
  - tray management 77
  - tray setting 30
- driver
  - installation 28
- duplex
  - copying 43
  - faxing 64
  - scanning 56, 72

## E

- email address
  - entering email addresses to input field 52
  - Global 52
  - Group 52
  - Individual 51
  - storing 51
- energy saver 30
- erasing background
  - copying 47
  - faxing 64
  - scanning 57, 73
- erasing punch hole 47

- error correction mode 78

- error message 97

- extension telephone 63

## F

- fax option kit
  - enabling option feature after installing the kit 114
  - ordering 110
- fax receiving
  - changing the receive mode 63
  - extension telephone 63
  - in answering machine/fax 63
  - in memory 64
  - secure receiving 63
- fax sending
  - automatic resending 62
  - delay sending 62
  - duplex sending 61
  - redialing the last number 62
  - sending a fax 61
  - sending a fax manually 62
  - sending a priority fax 63
  - setting a fax header 61
- fax setup 78
- faxing
  - color mode 64
  - darkness 64
  - enabling the fax kit option 81, 114
  - erasing background 64
  - original type 64
  - phonebook 64
  - printing a fax report 83
  - resolution 64
  - solving faxing problems 105

## FDI

- authentication 81

## FDI (Foreign Interface Device)

- ordering 111

## finisher (Stacker & Stapler)

- ordering 110
- paper jam 96

- front cover 18

- FTP 56

## G

- general settings 76

- Gray scan 57, 72

Group  
Group fax number 65

## I

ID copy 44  
ID stamp in copying 78  
imaging unit 18  
imaging unit reorder notification 83  
Individual  
email addresses for scanning 51  
individual fax number 65

## J

jam  
clearing paper from the duplex unit area  
96  
clearing paper from the exit area 95  
clearing paper from the fuser unit 95  
clearing paper from the multi-purpose  
tray 95  
clearing paper from the optional tray 92,  
93  
clearing paper from the stacker  
(finisher) 96  
clearing paper from the toner cartridge  
95  
clearing paper from the tray1 91  
clearing the original from scanner glass  
90  
tips for avoiding paper jams 89

jam, clear  
document 89

JPEG 58, 73

## K

keyboard 32

## L

language 30

### LED

Interrupt 21  
Status 22

Linux problems 107

loading originals  
ADF 33  
scanner glass 33

## M

Machine Info 75

Machine Setup 75  
machine status 76

### Mailbox

creating Mailbox 66  
deleting the data of the Mailbox 67  
Mailbox List 67  
Mailbox No. 66  
Mailbox Passcode 66  
polling 66  
printing a Mailbox 67  
sending to remote Mailbox 67  
storing the originals 67

### Maintenance

imaging unit 87  
maintenance parts 88  
toner cartridge 85, 86

### memory DIMM

installing 112

### memory module

installing 112  
ordering 110

message on the display screen 97

Mono 57, 72

multi-purpose tray 18

## N

network  
setting up 26, 80

notification  
receiving a fax in Mailbox 67

N-up copy 45

## O

OCR 58, 73

On Hook Dial  
sending a fax 62

optional service 81

optional tray 18, 110

### original size

copying 42  
scanning 57, 72

### original type

copying 44  
faxing 64  
scanning 57, 72

### originals

jam, clear 89  
loading 33

output options 77

## P

page numbering in copying 78

### paper

changing the size 37  
clearing jam 91  
loading in the multi-purpose tray 39  
loading in the optional tray 38  
loading in the tray1 38  
paper feeding problems 100

### paper type

setting 40

### phonebook

fax 64  
fax phonebook from SyncThru Web  
Service 65

### polling

deleting the polling document 66  
polling a remote fax 66  
polling from remote Mailbox 66  
printing the polling document 66  
storing the originals for polling 66

### PostScript

problems 106

Power Save 30

### Power Saver

using power save mode 30, 77

print quality problems, solve 102

### print/report

accounting reports 82  
configuration report 82  
e-mail confirmation report 82  
fax report 82, 83  
network auth. log report 82  
network configuration 82  
PCL font list 82  
PS3 font list 82  
scan report 83  
scan to server confirmation 82  
Schedule jobs report 82  
supplies information 82  
system report 83  
usage page report 82

### printing

problem solving 101  
USB memory 74

### problem, solve

Linux 107  
printing quality 102



## problems

- copying 104
- display message 97
- faxing 105
- paper feeder 100
- PostScript 106
- printing 101
- scanning 105
- touch screen 100
- Windows 106

## Q

### quality

- scanning 58, 73

## R

remote code 78

### replacing components

- imaging unit 87
- toner cartridge 85

replacing stapler 113

Report 82

### Resolution

- faxing 64
- scanning 56

## S

scan preset 58

### Scan to Email 51

- confirmation 82

### Scan to Server 56

- confirmation 82

scanned file format 58, 73

### scanner glass

- loading documents 33

scanner lid 18

Scanner lock switch 18

## scanning

- color mode 57, 72
- darkness 57, 73
- enabling the scan kit option 81
- erasing background 57, 73
- file format 58, 73
- original size 57, 72
- original type 57, 72
- printing an email report 83
- quality 58, 73
- resolution 56, 72
- scan preset 58
- sending it via email 51
- sending it via FTP 56
- sending it via SMB 56
- solving scanning problems 105
- USB flash memory 71

serial number 83

service center registration 76

shifting margin 47

side cover 18

SMB 56

sound 77

speed dial no. 65

Stacker 110

stand 18, 110

### staple cartridge

- ordering 110
- replacing 113

stored documents 84

### supplies

- browsing the supplies life 76
- checking the supplies life 83
- expected imaging unit life 77, 86
- expected toner cartridge life 77
- management 77

Supplies Management 77

### SyncThru Web Service

- email address 51
- fax settings 65
- SMB/FTP setting 56

System timeout 30

## T

telephone 63

terminal ID 78

TIFF 58, 73

toner cartridge 18

toner reorder notification 83

## touch screen

- problem solving 100

## tray

- adjusting the width and length 37
- optional tray 18
- tray1 18

## U

### USB flash memory

- printing 74
- scanning 71

### using

- SetIP 31

## W

### Windows

- problems 106

© 2010 Samsung Electronics Co., Ltd. All rights reserved.

This user's guide is provided for information purposes only. All information included herein is subject to change without notice. Samsung Electronics is not responsible for any direct or indirect damages, arising from or related to use of this user's guide.

- Samsung and Samsung logo are trademarks of Samsung Electronics Co., Ltd.
- PCL and PCL 6 are trademarks of Hewlett-Packard Company.
- Microsoft, Windows, Windows , Windows 7 and Windows 2008 Server R2 are either registered trademarks or trademarks of Microsoft Corporation.
- PostScript 3 is a trademark of Adobe System, Inc.
- UFST® and MicroType™ are registered trademarks of Monotype Imaging Inc.
- TrueType, LaserWriter and Macintosh are trademarks of Apple Computer, Inc.
- All other brand or product names are trademarks of their respective companies or organizations.
- Refer to the 'LICENSE.txt' file in the provided CD-ROM for the open source license information.





Samsung Printer

---

# Software section

# Software section

# Contents

## 1. Installing Printer Software in Windows

Installing Printer Software .....	5
Installing Software for Local Printing .....	5
Installing Software for Network Printing .....	8
Reinstalling Printer Software .....	11
Removing Printer Software .....	12

## 2. Basic Printing

Printing a Document .....	13
Printing to a file (PRN) .....	14
Printer Settings .....	14
Layout Tab .....	15
Paper Tab .....	15
Graphics Tab .....	16
Extras Tab .....	17
About Tab .....	18
Printer Tab .....	18
Using a Favorite Setting .....	18
Using Help .....	18

## 3. Advanced Printing

Printing Multiple Pages on One Sheet of Paper (N-Up Printing) .....	19
Printing Posters .....	20
Printing Booklets .....	20
Printing on Both Sides of Paper .....	21
Printing a Reduced or Enlarged Document .....	21
Fitting Your Document to a Selected Paper Size .....	21

Using Watermarks .....	22
Using an Existing Watermark .....	22
Creating a Watermark .....	22
Editing a Watermark .....	22
Deleting a Watermark .....	22
Using Overlays .....	23
What is an Overlay? .....	23
Creating a New Page Overlay .....	23
Using a Page Overlay .....	23
Deleting a Page Overlay .....	23

## 4. Using Windows PostScript Driver

Printer Settings .....	24
Advanced .....	24
Using Help .....	24

## 5. Using Direct Printing Utility

Overview Direct Printing Utility .....	25
Printing .....	25
From the Direct Printing Utility window .....	25
Using the shortcut icon .....	25
Using the right-click menu .....	25

## 6. Sharing the Printer Locally

Setting Up a Host Computer .....	26
Setting Up a Client Computer .....	26

## 7. Scanning

Scanning Using Samsung SmarThru Office .....	27
Using Samsung SmarThru Office .....	27
Uninstalling Samsung SmarThru Office .....	28
Using Onscreen Help File .....	29
Scanning Process with TWAIN-enabled Software .....	29



Scanning Using the WIA Driver .....	29
Windows XP/Server 2003 .....	29
Windows Vista .....	29
Windows 7 .....	30

## 8. Using Smart Panel

Understanding Smart Panel .....	31
Opening the Troubleshooting Guide .....	32
Changing the Smart Panel Program Settings .....	32

## 9. Using Your Printer in Linux

Getting Started .....	33
Installing the Unified Linux Driver .....	33
Installing the Unified Linux Driver .....	33
Installing the SmartPanel .....	33
Uninstalling the Unified Linux Driver .....	34
Using the Unified Driver Configurator .....	35
Opening the Unified Driver Configurator .....	35
Printers Configuration .....	35
Scanners Configuration .....	36
Ports Configuration .....	36
Configuring Printer Properties .....	37
Printing a Document .....	37
Printing from Applications .....	37
Printing Files .....	38
Scanning a Document .....	38
Using the Image Manager .....	39

## 10. Using Your Printer with a Macintosh

Installing Software .....	41
Uninstalling software .....	41
Setting Up the Printer .....	42
For a Network-connected .....	42

For a USB-connected .....	42
Printing .....	43
Printing a Document .....	43
Changing Printer Settings .....	43
Printing Multiple Pages on One Sheet of Paper .....	45
Duplex Printing .....	45
Scanning .....	46

# 1 Installing Printer Software in Windows

This chapter includes:

- **Installing Printer Software**
- **Reinstalling Printer Software**
- **Removing Printer Software**

**NOTE:** The following procedure is based on Windows XP, for other operating systems, refer to the corresponding Windows user's guide or online help.

## Installing Printer Software

You can install the printer software for local printing or network printing. To install the printer software on the computer, perform the appropriate installation procedure depending on the printer in use.

A printer driver is software that lets your computer communicate with your printer. The procedure to install drivers may differ depending on the operating system you are using.

All applications should be closed on your PC before beginning installation.

## Installing Software for Local Printing

A local printer is a printer directly attached to your computer using the printer cable supplied with your printer, such as a USB or parallel cable. If your printer is attached to a network, skip this step and go to "Installing Software for Network Printing" on page 8.

You can install the printer software using the typical or custom method.

**NOTE:** If the "New Hardware Wizard" window appears during the installation procedure, click  in the upper right corner of the box to close the window, or click **Cancel**.

## Typical Installation

This is recommended for most users. All components necessary for printer operations will be installed.

- 1 Make sure that the printer is connected to your computer and powered on.
- 2 Insert the supplied CD-ROM into your CD-ROM drive. The CD-ROM should automatically run, and an installation window appears. If the installation window does not appear, click **Start** and then **Run**. Type **X:\Setup.exe**, replacing "X" with the letter which represents your drive and click **OK**. If you use Windows Vista, Windows 7 and Windows Server 2008 R2, click **Start** → **All programs** → **Accessories** → **Run**, and type **X:\Setup.exe**. If the **AutoPlay** window appears in Windows Vista, Windows 7 and Windows Server 2008 R2, click **Run Setup.exe** in **Install or run program** field, and click **Continue** in the **User Account Control** window.
- 3 Click **Next**.

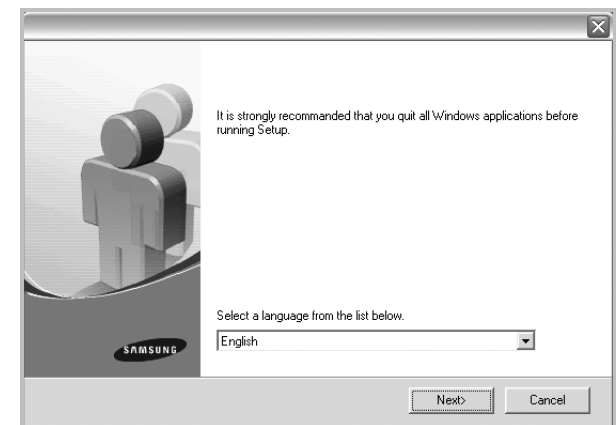

- If necessary, select a language from the drop-down list.

- 4 Select **Typical installation for a local printer**. Click **Next**.

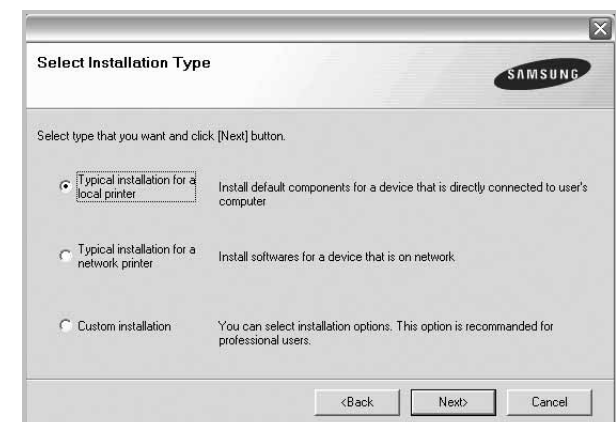

**NOTE:** If your printer is not already connected to the computer, the following window will appear.

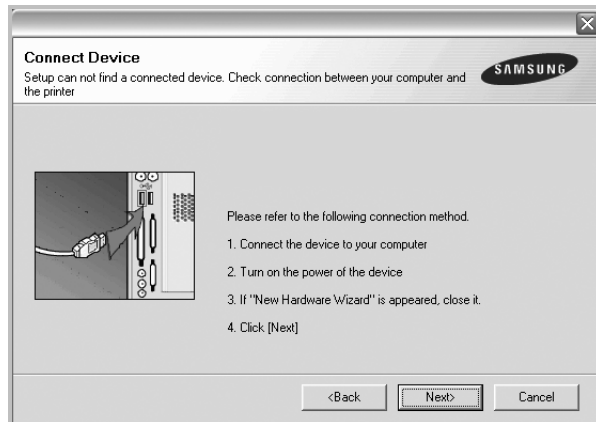

- After connecting the printer, click **Next**.
- If you don't want to connect the printer at this time, click **Next**, and **No** on the following screen. Then the installation will start and a test page will not be printed at the end of the installation.
- *The installation window that appears in this User's Guide may differ depending on the printer and interface in use.*

- 5 After the installation is finished, a window asking you to print a test page appears. If you choose to print a test page, select the checkbox and click **Next**. Otherwise, just click **Next** and skip to step 7.
- 6 If the test page prints out correctly, click **Yes**. If not, click **No** to reprint it.
- 7 To register yourself as a user of Samsung Printers in order to receive information from Samsung, select the checkbox and click **Finish**. You are now sent to the Samsung web site. Otherwise, just click **Finish**.

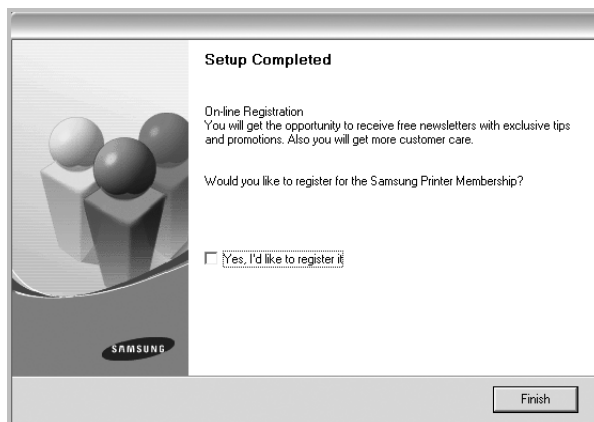

**NOTE:** After setup is complete, if your printer driver doesn't work properly, reinstall the printer driver. See "Reinstalling Printer Software" on page 11.

## Custom Installation

You can choose individual components to install.

- 1 Make sure that the printer is connected to your computer and powered on.
- 2 Insert the supplied CD-ROM into your CD-ROM drive. The CD-ROM should automatically run, and an installation window appears. If the installation window does not appear, click **Start** and then **Run**. Type **X:\Setup.exe**, replacing "X" with the letter which represents your drive and click **OK**. If you use Windows Vista, Windows 7 and Windows Server 2008 R2, click **Start** → **All programs** → **Accessories** → **Run**, and type **X:\Setup.exe**. If the **AutoPlay** window appears in Windows Vista, Windows 7 and Windows Server 2008 R2, click **Run Setup.exe** in **Install or run program** field, and click **Continue** in the **User Account Control** window.
- 3 Click **Next**.

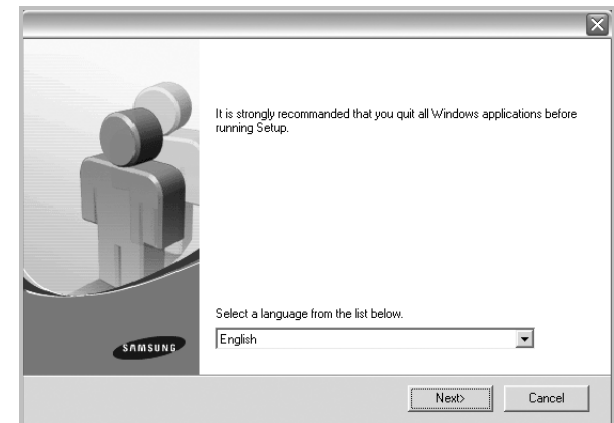

- If necessary, select a language from the drop-down list.

- 4 Select **Custom installation**. Click **Next**.

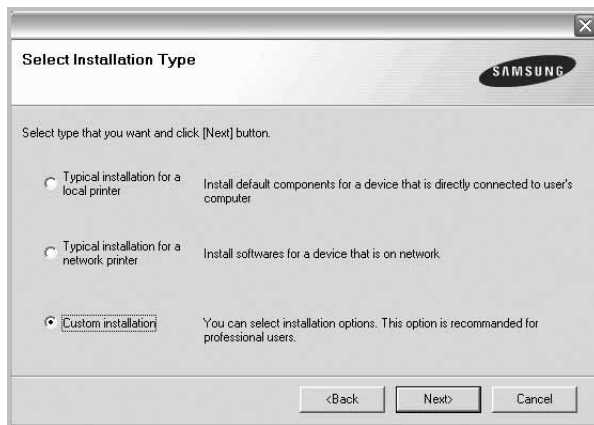

- 5 Select your printer and click **Next**.

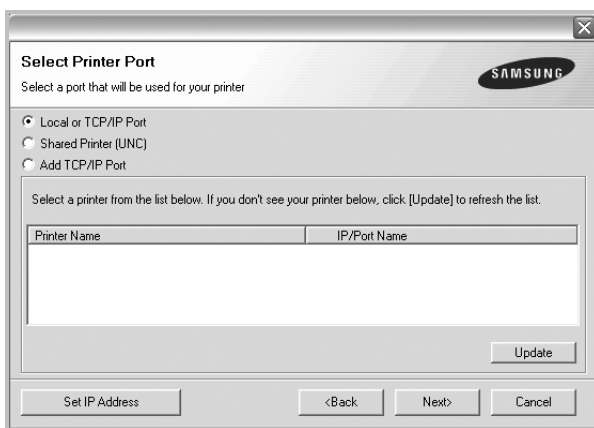

**NOTE:** If your printer is not already connected to the computer, the following window will appear.

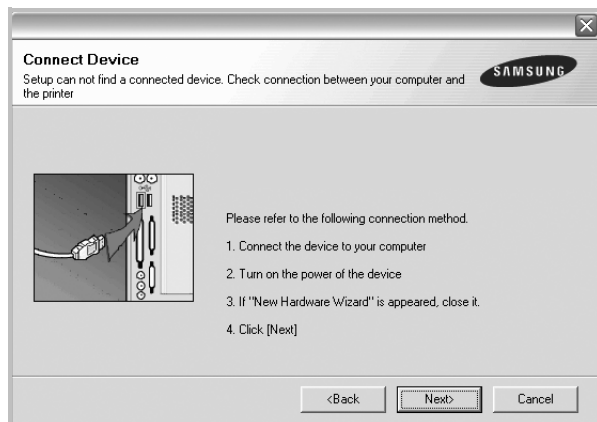

- After connecting the printer, click **Next**.
- If you don't want to connect the printer at this time, click **Next**, and **No** on the following screen. Then the installation will start and a test page will not be printed at the end of the installation.

• *The installation window that appears in this User's Guide may differ depending on the printer and interface in use.*

- 6 Select the components to be installed and click **Next**.

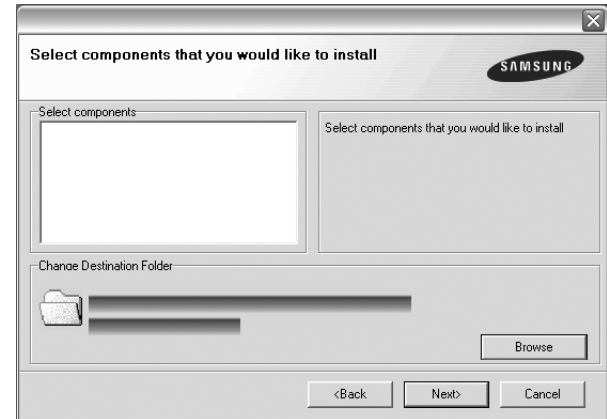

**NOTE:** You can change the desired installation folder by clicking [**Browse**].

- 7 After the installation is finished, a window asking you to print a test page appears. If you choose to print a test page, select the checkbox and click **Next**. Otherwise, just click **Next** and skip to step 9.
- 8 If the test page prints out correctly, click **Yes**. If not, click **No** to reprint it.
- 9 To register yourself as a user of Samsung Printers in order to receive information from Samsung, select the checkbox and click **Finish**. You are now sent to the Samsung web site.

Otherwise, just click **Finish**.

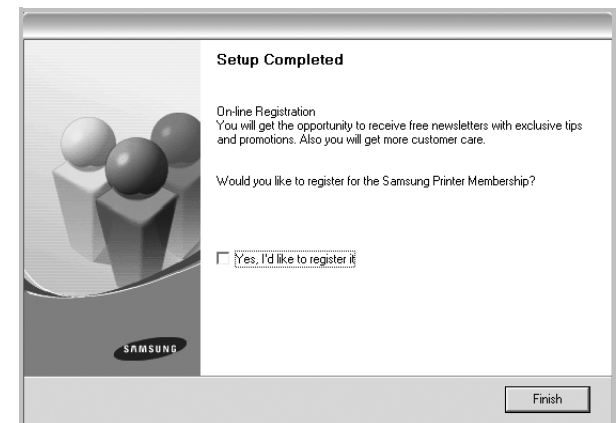

## Installing Software for Network Printing

When you connect your printer to a network, you must first configure the TCP/IP settings for the printer. After you have assigned and verified the TCP/IP settings, you are ready to install the software on each computer on the network.

You can install the printer software using the typical or custom method.

### Typical Installation

This is recommended for most users. All components necessary for printer operations will be installed.

- 1 Make sure that the printer is connected to your network and powered on. For details about connecting to the network, see the supplied printer's User's Guide.
- 2 Insert the supplied CD-ROM into your CD-ROM drive. The CD-ROM should automatically run, and an installation window appears.  
If the installation window does not appear, click **Start** and then **Run**. Type **X:\Setup.exe**, replacing "X" with the letter which represents your drive and click **OK**.  
If you use Windows vista, Windows 7 and Windows Server 2008 R2, click **Start** → **All programs** → **Accessories** → **Run**, and type **X:\Setup.exe**.  
If the **AutoPlay** window appears in Windows vista, Windows 7 and Windows Server 2008 R2, click **Run Setup.exe** in **Install or run program** field, and click **Continue** in the **User Account Control** window.
- 3 Click **Next**.

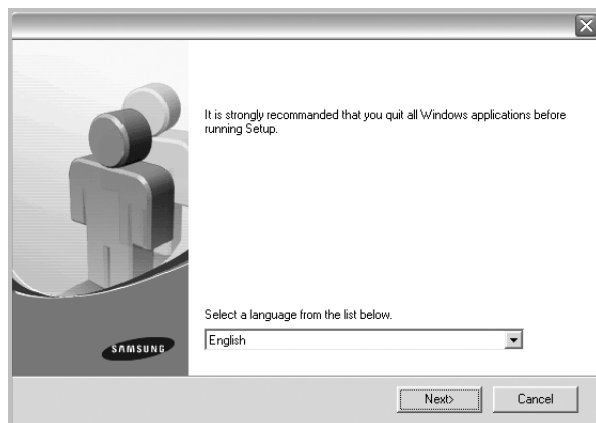

- If necessary, select a language from the drop-down list.

- 4 Select **Typical installation for a network printer**. Click **Next**.

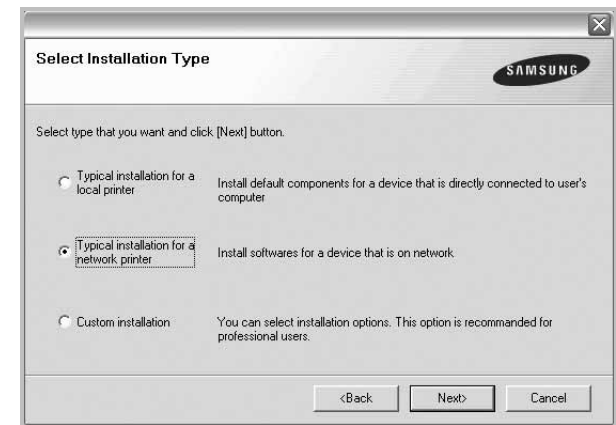

- 5 The list of printers available on the network appears. Select the printer you want to install from the list and then click **Next**.

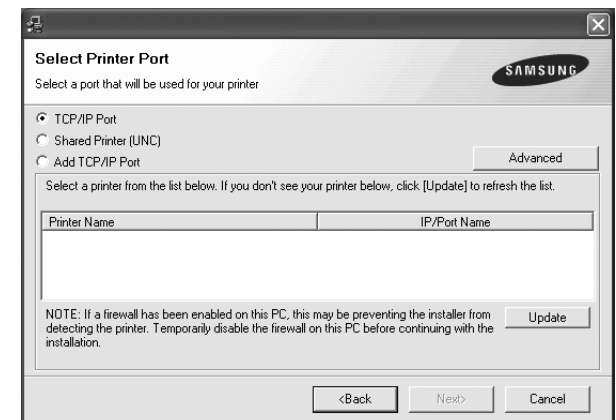

- If you click the **Advanced** button, you can search a printer with the **SNMP Community name**. Default name is 'public'
- If you do not see your printer on the list, click **Update** to refresh the list, or select **Add TCP/IP Port** to add your printer to the network. To add the printer to the network, enter the port name and the IP address for the printer.

To verify your printer's IP address or the MAC address, print a Network Configuration page.

- To find a shared network printer (UNC Path), select **Shared Printer [UNC]** and enter the shared name manually or find a shared printer by clicking the **Browse** button.

**NOTE:** If you cannot find your machine in network, please turn off the firewall and click **Update**.

For Windows operating system, click **Start** → **Control Panel**



and start windows firewall, and set this option unactivated. For other operating system, refer to its on-line guide.

---

- 6 After the installation is finished, a window appears asking you to print a test page and to register yourself as a user of Samsung Printers in order to receive information from Samsung. If you so desire, select the corresponding checkbox(es) and click **Finish**.

Otherwise, just click **Finish**.

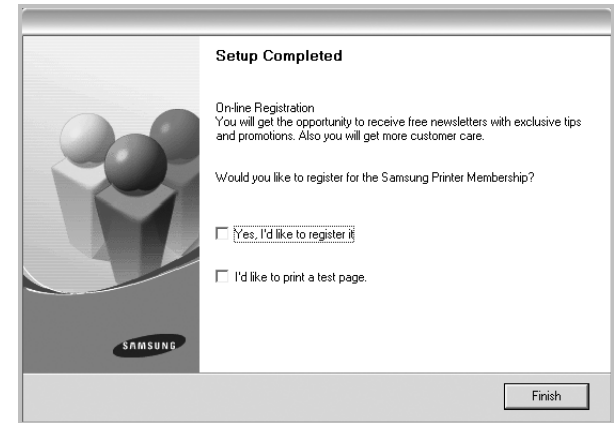

---

**NOTE:** After setup is complete, if your printer driver doesn't work properly, reinstall the printer driver. See "Reinstalling Printer Software" on page 11.

---

## Custom Installation

You can choose individual components to install and set a specific IP address.

- 1 Make sure that the printer is connected to your network and powered on. For details about connecting to the network, see the supplied printer's User's Guide.
- 2 Insert the supplied CD-ROM into your CD-ROM drive. The CD-ROM should automatically run, and an installation window appears.  
If the installation window does not appear, click **Start** and then **Run**. Type **X:\Setup.exe**, replacing "X" with the letter which represents your drive and click **OK**.  
If you use Windows vista, Windows 7 and Windows Server 2008 R2, click **Start** → **All programs** → **Accessories** → **Run**, and type **X:\Setup.exe**.  
If the **AutoPlay** window appears in Windows vista, Windows 7 and Windows Server 2008 R2, click **Run Setup.exe** in **Install or run program** field, and click **Continue** in the **User Account Control** window.

3 Click **Next**.

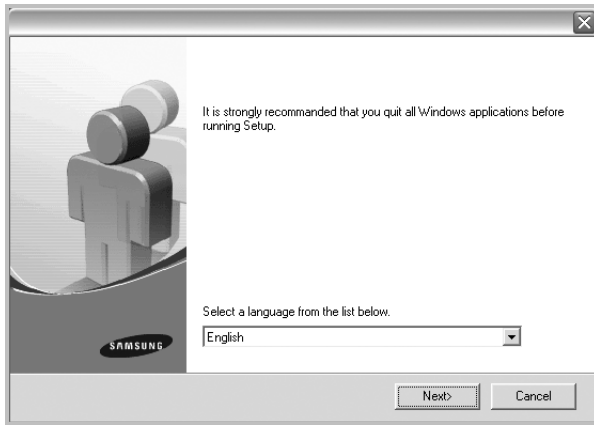

- If necessary, select a language from the drop-down list.

4 Select **Custom installation**. Click **Next**.

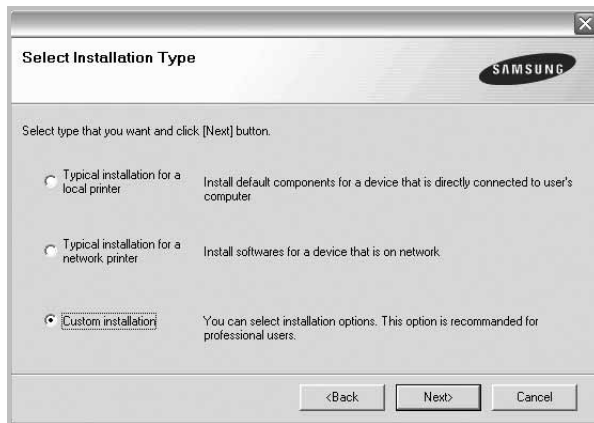

5 The list of printers available on the network appears. Select the printer you want to install from the list and then click **Next**.

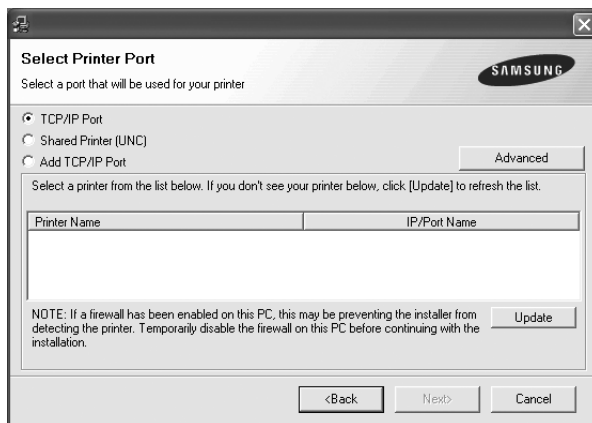

- If you click the **Advanced** button, you can search a printer with the **SNMP Community name**. Default name is 'public'

- If you do not see your printer on the list, click **Update** to refresh the list, or select **Add TCP/IP Port** to add your printer to the network. To add the printer to the network, enter the port name and the IP address for the printer.

To verify your printer's IP address or the MAC address, print a Network Configuration page.

- To find a shared network printer (UNC Path), select **Shared Printer [UNC]** and enter the shared name manually or find a shared printer by clicking the **Browse** button.

**NOTE:** If you cannot find your machine in network, please turn off the firewall and click **Update**.

For Windows operating system, click **Start** → **Control Panel** and start windows firewall, and set this option unactivated. For other operating system, refer to its on-line guide.

**TIP:** If you want to set a specific IP address on a specific network printer, click the **Set IP Address** button. The Set IP Address window appears. Do as follows:

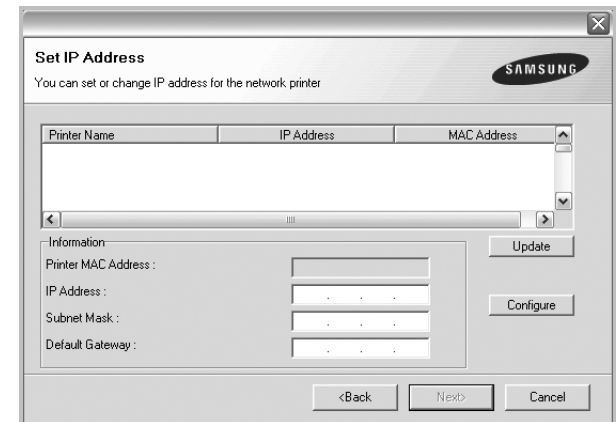

- a. Select a printer to be set with a specific IP address from the list.
- b. Configure an IP address, subnet mask, and gateway for the printer manually and click **Configure** to set the specific IP address for the network printer.
- c. Click **Next**.

- 6 Select the components to be installed. After selecting the components, the following window appears. You can also change the printer name, set the printer to be shared on the network, set the printer as the default printer, and change the port name of each printer. Click **Next**.



To install this software on a server, select the **Setting up this printer on a server** checkbox.

- 7 After the installation is finished, a window appears asking you to print a test page and to register yourself as a user of Samsung Printers in order to receive information from Samsung. If you so desire, select the corresponding checkbox(es) and click **Finish**.

Otherwise, just click **Finish**.

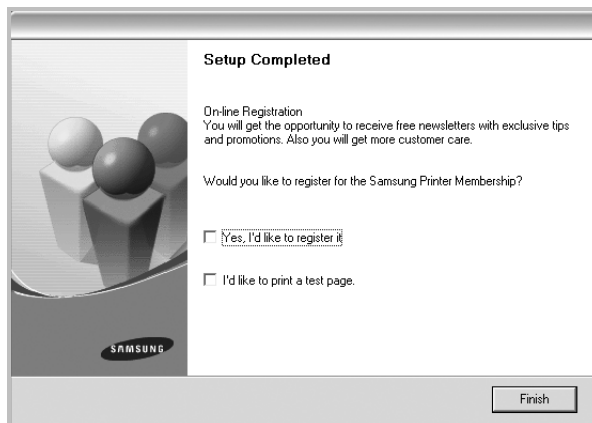

**NOTE:** After setup is complete, if your printer driver doesn't work properly, reinstall the printer driver. See "Reinstalling Printer Software" on page 11.

## Reinstalling Printer Software

You can reinstall the software if installation fails.

- 1 Start Windows.
- 2 From the **Start** menu select **Programs** or **All Programs** → **your printer driver name** → **Maintenance**.
- 3 Select **Repair** and click **Next**.
- 4 The list of printers available on the network appears. Select the printer you want to install from the list and then click **Next**.

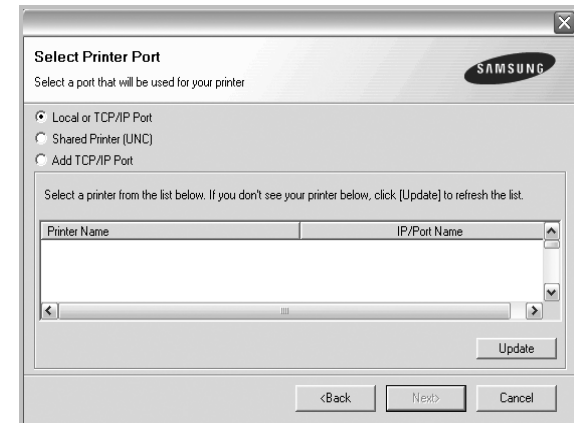

- If you do not see your printer on the list, click **Update** to refresh the list, or select **Add TCP/IP Port** to add your printer to the network. To add the printer to the network, enter the port name and the IP address for the printer.
- To find a shared network printer (UNC Path), select **Shared Printer [UNC]** and enter the shared name manually or find a shared printer by clicking the **Browse** button.

You will see a component list so that you can reinstall any item individually.

**NOTE:** If your printer is not already connected to the computer, the following window will appear.

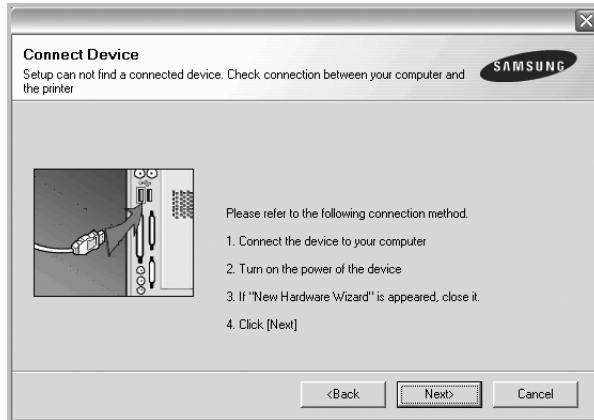

- After connecting the printer, click **Next**.
- If you don't want to connect the printer at this time, click **Next**, and **No** on the following screen. Then the installation will start and a test page will not be printed at the end of the installation.
- *The reinstallation window that appears in this User's Guide may differ depending on the printer and interface in use.*

- 5 Select the components you want to reinstall and click **Next**.

If you installed the printer software for local printing and you select **your printer driver name**, the window asking you to print a test page appears. Do as follows:

- a. To print a test page, select the check box and click **Next**.
  - b. If the test page prints out correctly, click **Yes**.  
If it doesn't, click **No** to reprint it.
- 6 When the reinstallation is done, click **Finish**.

## Removing Printer Software

- 1 Start Windows.
- 2 From the **Start** menu select **Programs** or **All Programs** → **your printer driver name** → **Maintenance**.
- 3 Select **Remove** and click **Next**.  
You will see a component list so that you can remove any item individually.
- 4 Select the components you want to remove and then click **Next**.
- 5 When your computer asks you to confirm your selection, click **Yes**.  
The selected driver and all of its components are removed from your computer.
- 6 After the software is removed, click **Finish**.

## 2 Basic Printing

This chapter explains the printing options and common printing tasks in Windows.

This chapter includes:



- **Printing a Document**
- **Printing to a file (PRN)**
- **Printer Settings**
  - **Layout Tab**
  - **Paper Tab**
  - **Graphics Tab**
  - **Extras Tab**
  - **About Tab**
  - **Printer Tab**
  - **Using a Favorite Setting**
  - **Using Help**

---

### Printing a Document

---

#### NOTES:

- Your printer driver **Properties** window that appears in this User's Guide may differ depending on the printer in use. However the composition of the printer properties window is similar.
- *Check the Operating System(s) that are compatible with your printer. Please refer to the OS Compatibility section of Printer Specifications in your Printer User's Guide.*
- If you need to know the exact name of your printer, you can check the supplied CD-ROM.
- When you select an option in printer properties, you may see an exclamationmark  or  mark. An exclamation mark means you can select that certain option but it is not recommended, and  mark means you cannot select that option due to the machine's setting or environment.

---

The following procedure describes the general steps required for printing from various Windows applications. The exact steps for printing a document may vary depending on the application program you are using. Refer to the User's Guide of your software application for the exact printing procedure.

- 1 Open the document you want to print.
- 2 Select **Print** from the **File** menu. The Print window is displayed. It may look slightly different depending on your application.

The basic print settings are selected within the Print window. These settings include the number of copies and print range.

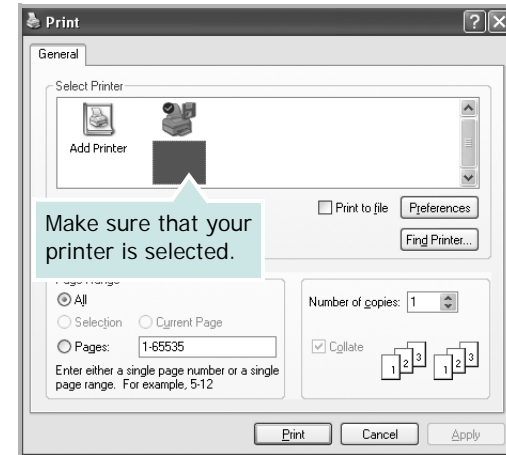

- 3 Select **your printer driver** from the **Name** drop-down list.

To take advantage of the printer features provided by your printer driver, click **Properties** or **Preferences** in the application's Print window. For details, see "Printer Settings" on page 14.

If you see **Setup, Printer, or Options** in your Print window, click it instead. Then click **Properties** on the next screen.

Click **OK** to close the printer properties window.

- 4 To start the print job, click **OK** or **Print** in the Print window.

---

## Printing to a file (PRN)

You will sometimes need to save the print data as a file for your purpose.

To create a file:

- 1 Check the **Print to file** box at the **Print** window.

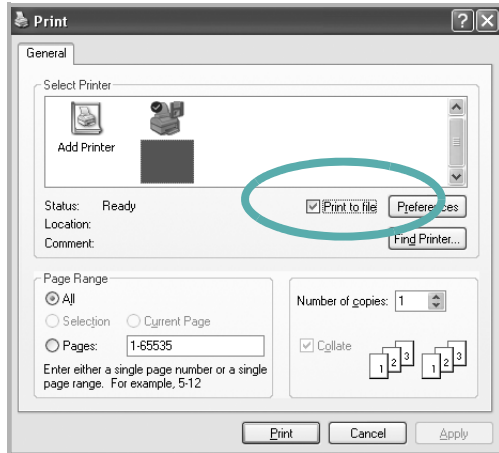

- 2 Select the folder and assign a name of the file and then click OK.

---

## Printer Settings

You can use the printer properties window, which allows you to access all of the printer options you need when using your printer. When the printer properties are displayed, you can review and change the settings needed for your print job.

Your printer properties window may differ, depending on your operating system. This Software User's Guide shows the Properties window for Windows XP.

Your printer driver **Properties** window that appears in this User's Guide may differ depending on the printer in use.

If you access printer properties through the Printers folder, you can view additional Windows-based tabs (refer to your Windows User's Guide) and the Printer tab (see "Printer Tab" on page 18).

---

### NOTES:

- Most Windows applications will override settings you specify in the printer driver. Change all print settings available in the software application first, and change any remaining settings using the printer driver.
  - The settings you change remain in effect only while you are using the current program. **To make your changes permanent**, make them in the Printers folder.
  - The following procedure is for Windows XP. For other Windows OS, refer to the corresponding Windows User's Guide or online help.
    1. Click the Windows **Start** button.
    2. Select **Printers and Faxes**.
    3. Select **your printer driver icon**.
    4. Right-click on the printer driver icon and select **Printing Preferences**.
    5. Change the settings on each tab, click OK.
-



## Layout Tab

The **Layout** tab provides options to adjust how the document appears on the printed page. The **Layout Options** includes **Multiple Pages per Side**, **Poster Printing** and **Booklet Printing**. See “Printing a Document” on page 13 for more information on accessing printer properties.

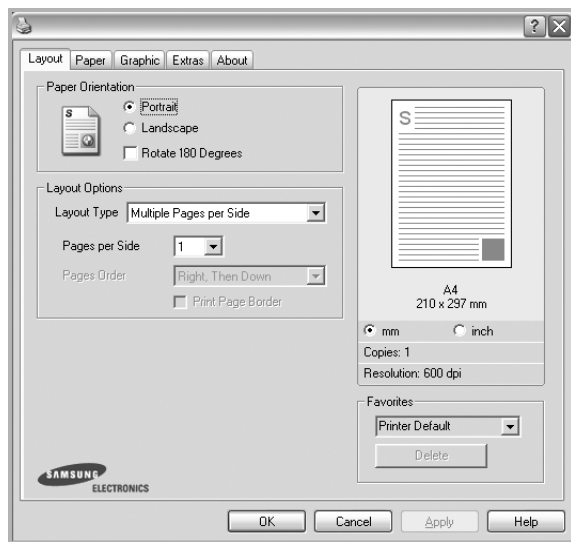

### Paper Orientation

**Paper Orientation** allows you to select the direction in which information is printed on a page.

- **Portrait** prints across the width of the page, letter style.
- **Landscape** prints across the length of the page, spreadsheet style.
- **Rotate** allows you to rotate the page the selected degrees.

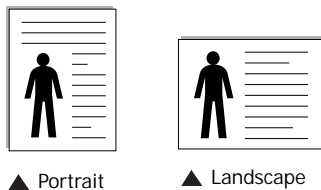

### Layout Options

**Layout Options** allows you to select advanced printing options. You can choose **Multiple Pages per Side** and **Poster Printing**.

- For details, see “Printing Multiple Pages on One Sheet of Paper (N-Up Printing)” on page 19.
- For details, see “Printing Posters” on page 20.
- For details, see “Printing Booklets” on page 20.

### Double-sided Printing

**Double-sided Printing** allows you to print on both sides of paper. *If this option does not appear, your printer does not have this feature.*

- For details, see “Printing on Both Sides of Paper” on page 21.

## Paper Tab

Use the following options to set the basic paper handling specifications when you access the printer properties. See “Printing a Document” on page 13 for more information on accessing printer properties.

Click the **Paper** tab to access various paper properties.

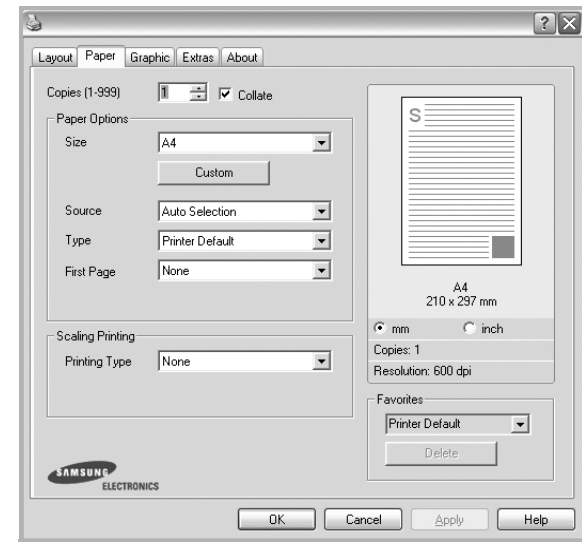

### Copies

**Copies** allows you to choose the number of copies to be printed. You can select 1 to 999 copies.

### Paper Options

#### Size

**Size** allows you to set the size of paper you loaded in the tray. If the required size is not listed in the **Size** box, click **Custom**. When the **Custom Paper Setting** window appears, set the paper size and click **OK**. The setting appears in the list so that you can select it.

#### Source

Make sure that **Source** is set to the corresponding paper tray. Use **Manual Feeder** when printing on special materials like envelopes and transparencies. You have to load one sheet at a time into the Manual Tray or Multi-Purpose Tray. If the paper source is set to **Auto Selection**, the printer automatically picks up print material in the following tray order: Manual Tray or Multi-Purpose Tray, Tray n.

#### Type

Set **Type** to correspond to the paper loaded in the tray from which you want to print. This will let you get the best quality printout. If not, print quality may not be achieved as you want.

**Thick Paper:** 24 lb to 28 lb (90~105 g/m<sup>2</sup>) thick paper.

**Thin Paper:** 16 lb to 19 lb (60~70 g/m<sup>2</sup>) thin paper.

**Cotton:** 20 lb to 24 lb (75~90 g/m<sup>2</sup>) cotton paper such as Gilbert 25 % and Gilbert 100 %.

**Plain Paper:** Normal plain paper. Select this type if your printer is monochrome and printing on the 16 lb (60 g/m<sup>2</sup>) cotton paper.

**Recycled Paper:** 20 lb to 24 lb (75~90 g/m<sup>2</sup>) recycled paper.

**Color Paper:** 20 lb to 24 lb (75~90 g/m<sup>2</sup>) color-backgrounded paper.

**Archive Paper:** If you need to keep print-out for a long period time such as archives, select this option.

### First Page

This property allows you to print the first page using a different paper type from the rest of the document. You can select the paper source for the first page.

For example, load thick stock for the first page into the Multi-purpose Tray, and plain paper into Tray n. Then, select **Tray n** in the **Source** option and **Multi-Purpose Tray** in the **First Page** option. *If this option does not appear, your printer does not have this feature.*

### Scaling Printing

**Scaling Printing** allows you to automatically or manually scale your print job on a page. You can choose from **None**, **Reduce/Enlarge**, and **Fit to Page**.

- For details, see “Printing a Reduced or Enlarged Document” on page 21.
- For details, see “Fitting Your Document to a Selected Paper Size” on page 21.

## Graphics Tab

Use the following Graphic options to adjust the print quality for your specific printing needs. See “Printing a Document” on page 13 for more information on accessing printer properties.

Click the **Graphic** tab to display the properties shown below.

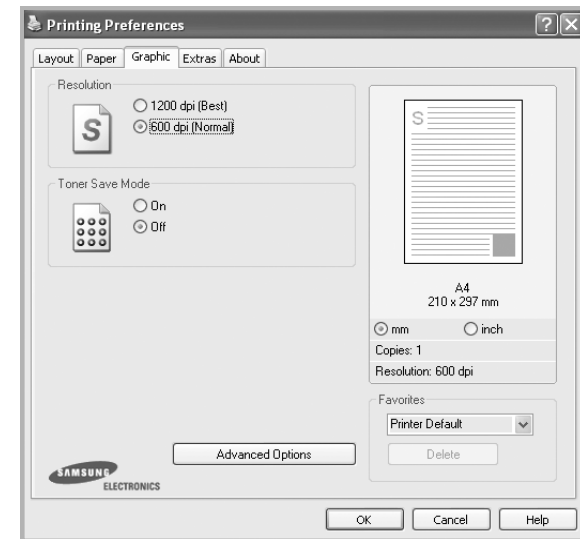

### Resolution

*The Resolution options you can select may vary depending on your printer model.* The higher the setting, the sharper the clarity of printed characters and graphics. The higher setting also may increase the time it takes to print a document.

### Toner Save Mode

Selecting this option extends the life of your toner cartridge and reduces your cost per page without a significant reduction in print quality. *Some printers do not support this feature.*

- **On:** Select this option to allow the printer to use less toner on each page.
- **Off:** If you don't need to save toner when printing a document, select this option.

## Advanced Options

You can set advanced settings by clicking the **Advanced Options** button.

- **TrueType Options:** This option determines what the driver tells the printer about how to image the text in your document. Select the appropriate setting according to the status of your document.
  - **Download as Outline:** When this option is selected, the driver will download any TrueType fonts that are used in your document not already stored (resident) on your printer. If, after printing a document, you find that the fonts did not print correctly, choose Download as bit image and resubmit your print job. The Download as bit image setting is often useful when printing Adobe. *This feature is available only when you use the PCL printer driver.*
  - **Download as Bitmap:** When this option is selected, the driver will download the font data as bitmap images. Documents with complicated fonts, such as Korean or Chinese, or various other fonts, will print faster in this setting.
  - **Print as Graphics:** When this option is selected, the driver will download any fonts as graphics. When printing documents with high graphic content and relatively few TrueType fonts, printing performance (speed) may be enhanced in this setting.
- **Print All Text To Black:** When the **Print All Text To Black** option is checked, all text in your document prints solid black, regardless of the color it appears on the screen.

## Extras Tab

You can select output options for your document. See “Printing a Document” on page 13 for more information about accessing the printer properties.

Click the **Extras** tab to access the following feature:

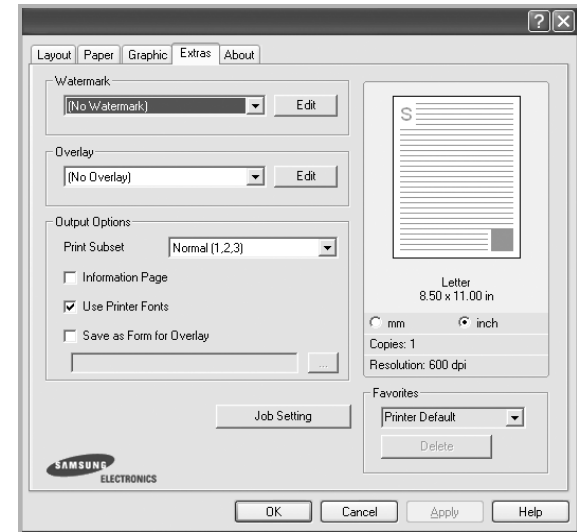

### Watermark

You can create a background text image to be printed on each page of your document. For details, see “Using Watermarks” on page 22.

### Overlay

Overlays are often used to take the place of preprinted forms and letterhead paper. For details, see “Using Overlays” on page 23.

### Output Options

- **Print Subset:** You can set the sequence in which the pages print. Select the print order from the drop-down list.
  - **Normal (1,2,3):** Your printer prints all pages from the first page to the last page.
  - **Reverse All Pages (3,2,1):** Your printer prints all pages from the last page to the first page.
  - **Print Odd Pages:** Your printer prints only the odd numbered pages of the document.
  - **Print Even Pages:** Your printer prints only the even numbered pages of the document.
- **Staple:** Do the stapling on the printouts.
- **Request Offset:** If you want the printouts to be sorted the same way as the original, the machine places printout sets slightly offset from one another.

### More Options

- **Information Page:** Select Information Page to print a cover sheet containing the printer name, the network user ID, job name before printing the document. When several users send a print job to the printer, this option allows you to easily find your documents in the output tray.

- **Use Printer Fonts:** When Use Printer Fonts is checked, the printer uses the fonts that are stored in its memory (resident fonts) to print your document, rather than downloading the fonts used in your document. Because downloading fonts takes time, selecting this option can speed up your printing time. When using Printer fonts, the printer will try to match the fonts used in your document to those stored in its memory. If, however, you use fonts in your document that are very different from those resident in the printer, your printed output will appear very different from what it looks like on the screen. *This feature is available only when you use the PCL printer driver.*
- **Save as Form for Overlay:** Select Save as Form for Overlay to save the document as a form file (C:\FORMOVER\\*.FOM). Once this option is selected, the printer driver requires the file name and the destination path each time you print. If you want to preset the file name and specify the path, click on the button in the Output to area, and type the file name and specify the path. *This feature is available only when you use the PCL printer driver.*

### Job Setting

Job Setting dialog allows you to select how to print or save the printing file by using the HDD. *Some printers do not support this feature.*

#### Using Onscreen Help File

- For more information about **Job Setting**, click  at the top right corner of the window. The **Job Setting** Help window opens and allows you to view onscreen help supplied on the **Job Setting**.

### About Tab

Use the **About** tab to display the copyright notice and the version number of the driver. If you have an Internet browser, you can connect to the Internet by clicking on the web site icon. See "Printing a Document" on page 13 for more information about accessing printer properties.

### Printer Tab

If you access printer properties through the **Printers** folder, you can view the **Printer** tab. You can set the printer configuration.

The following procedure is for Windows XP. For other Windows OS, refer to the corresponding Windows User's Guide or online help.

- 1 Click the Windows **Start** menu.
- 2 Select **Printers and Faxes**.
- 3 Select **your printer driver** icon.

- 4 Right-click on the printer driver icon and select **Properties**.

- 5 Click the **Printer** tab and set the options.

### Using a Favorite Setting

The **Favorites** option, which is visible on each properties tab, allows you to save the current properties settings for future use.

To save a **Favorites** item:

- 1 Change the settings as needed on each tab.
- 2 Enter a name for the item in the **Favorites** input box.

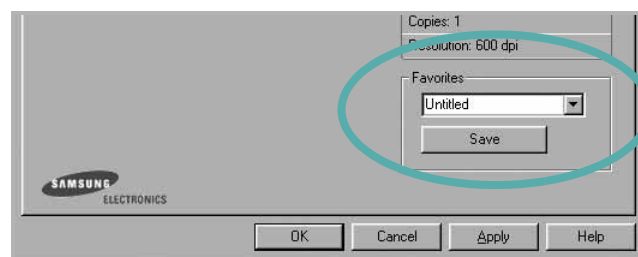

- 3 Click **Save**.

When you save **Favorites**, all current driver settings are saved.

To use a saved setting, select the item from the **Favorites** drop down list. The printer is now set to print according to the Favorites setting you selected.

To delete a Favorites item, select it from the list and click **Delete**.

You can also restore the printer driver's default settings by selecting **Printer Default** from the list.

### Using Help

Your printer has a help screen that can be activated by clicking the **Help** button in the printer properties window. These help screens give detailed information about the printer features provided by the printer driver.

You can also click  from the upper right corner of the window, and then click on any setting.

# 3 Advanced Printing

This chapter explains printing options and advanced printing tasks.

---

**NOTE:**

- Your printer driver **Properties** window that appears in this User's Guide may differ depending on the printer in use. However the composition of the printer properties window is similar.
  - If you need to know the exact name of your printer, you can check the supplied CD-ROM.
- 

This chapter includes:

- **Printing Multiple Pages on One Sheet of Paper (N-Up Printing)**
- **Printing Posters**
- **Printing Booklets**
- **Printing on Both Sides of Paper**
- **Printing a Reduced or Enlarged Document**
- **Fitting Your Document to a Selected Paper Size**
- **Using Watermarks**
- **Using Overlays**

---

## Printing Multiple Pages on One Sheet of Paper (N-Up Printing)



You can select the number of pages to print on a single sheet of paper. To print more than one page per sheet, the pages will be reduced in size and arranged in the order you specify. You can print up to 16 pages on one sheet.

- 1** To change the print settings from your software application, access printer properties. See “Printing a Document” on page 13.
- 2** From the **Layout** tab, choose **Multiple Pages per Side** in the **Layout Type** drop-down list.
- 3** Select the number of pages you want to print per sheet (1, 2, 4, 6, 9, or 16) in the **Pages per Side** drop-down list.
- 4** Select the page order from the **Page Order** drop-down list, if necessary.  
Check **Print Page Border** to print a border around each page on the sheet.
- 5** Click the **Paper** tab, select the paper source, size, and type.
- 6** Click **OK** and print the document.

## Printing Posters

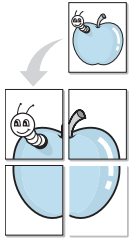

This feature allows you to print a single-page document onto 4, 9, or 16 sheets of paper, for the purpose of pasting the sheets together to form one poster-size document.

- 1 To change the print settings from your software application, access printer properties. See “Printing a Document” on page 13.
- 2 Click the **Layout** tab, select **Poster Printing** in the **Layout Type** drop-down list.
- 3 Configure the poster option:  
You can select the page layout from **Poster<2x2>**, **Poster<3x3>**, **Poster<4x4>** or **Custom**. If you select **Poster<2x2>**, the output will be automatically stretched to cover 4 physical pages. If the option is set to Custom, you can enlarge the original from 150% to 400%. Depending on the level of the enlargement, the page layout is automatically adjusted to **Poster<2x2>**, **Poster<3x3>**, **Poster<4x4>**.

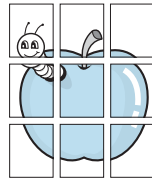
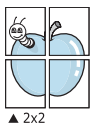

Specify an overlap in millimeters or inches to make it easier to pasting the sheets together.

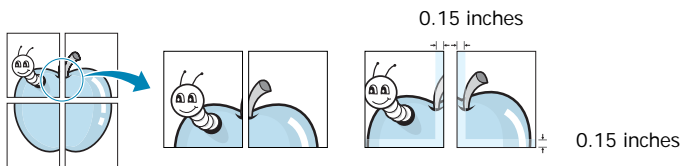

- 4 Click the **Paper** tab, select the paper source, size, and type.
- 5 Click **OK** and print the document. You can complete the poster by pasting the sheets together.

## Printing Booklets

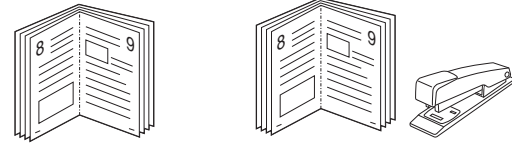

This printer feature allows you to print your document on both sides of the paper and arranges the pages so that the paper can be folded in half after printing to produce a booklet.

- 1 To change the print settings from your software application, access the printer properties. See “Printing a Document” on page 13.
- 2 From the **Layout** tab, choose **Booklet Printing** from the **Layout Type** drop-down list.

**NOTE:** The **Booklet Printing** option is not available for all paper sizes. In order to find out the available paper size for this feature, select the paper size in the **Size** option on the **Paper** tab, then check if the **Booklet Printing** in a **Layout Type** drop-down list on the **Layout** tab is activated.

- 3 Click the **Paper** tab, and select the paper source, size, and type.
- 4 Click **OK** and print the document.
- 5 After printing, fold and staple the pages.



## Printing on Both Sides of Paper

You can print on both sides of a sheet of paper. Before printing, decide how you want your document oriented.

The options are:

- **Printer Setting**, if you select this option, this feature is determined by the setting you've made on the control panel of the printer. *If this option does not appear, your printer does not have this feature.*
- **None**
- **Long Edge**, which is the conventional layout used in book binding.
- **Short Edge**, which is the type often used with calendars.

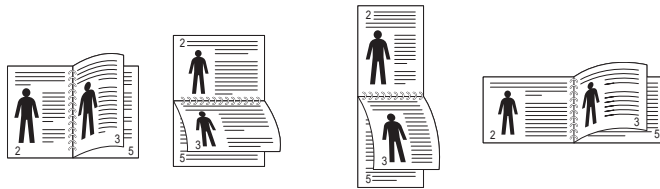

? Long Edge

? Short Edge

- **Reverse Duplex Printing**, allows you to select general print order compare to duplex print order. *If this option does not appear, your printer does not have this feature.*

**NOTE:** Do not print on both sides of labels, transparencies, envelopes, or thick paper. Paper jamming and damage to the printer may result.

- 1 To change the print settings from your software application, access printer properties. "Printing a Document" on page 13.
- 2 From the **Layout** tab, select the paper orientation.
- 3 From the **Double-sided Printing** section, select the binding option you want.
- 4 Click the **Paper** tab and select the paper source, size, and type.
- 5 Click **OK** and print the document.

**NOTE:** If your printer does not have a duplex unit, you should complete the printing job manually. The printer prints every other page of the document first. After printing the first side of your job, the Printing Tip window appears. Follow the on-screen instructions to complete the printing job.

## Printing a Reduced or Enlarged Document

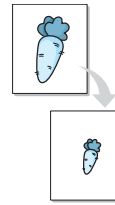

You can change the size of a page's content to appear larger or smaller on the printed page.

- 1 To change the print settings from your software application, access printer properties. See "Printing a Document" on page 13.
- 2 From the **Paper** tab, select **Reduce/Enlarge** in the **Printing Type** drop-down list.
- 3 Enter the scaling rate in the **Percentage** input box. You can also click the ▼ or ▲ button.
- 4 Select the paper source, size, and type in **Paper Options**.
- 5 Click **OK** and print the document.

## Fitting Your Document to a Selected Paper Size

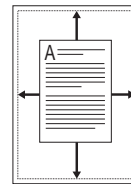

This printer feature allows you to scale your print job to any selected paper size regardless of the digital document size. This can be useful when you want to check fine details on a small document.

- 1 To change the print settings from your software application, access printer properties. See "Printing a Document" on page 13.
- 2 From the **Paper** tab, select **Fit to Page** in the **Printing Type** drop-down list.
- 3 Select the correct size from the **Output size** drop-down list.
- 4 Select the paper source, size, and type in **Paper Options**.
- 5 Click **OK** and print the document.

---

## Using Watermarks

The Watermark option allows you to print text over an existing document. For example, you may want to have large gray letters reading "DRAFT" or "CONFIDENTIAL" printed diagonally across the first page or all pages of a document.

There are several predefined watermarks that come with the printer, and they can be modified, or you can add new ones to the list.

### Using an Existing Watermark

- 1 To change the print settings from your software application, access printer properties. See "Printing a Document" on page 13.
- 2 Click the **Extras** tab, and select the desired watermark from the **Watermark** drop-down list. You will see the selected watermark in the preview image.
- 3 Click **OK** and start printing.

---

**NOTE:** The preview image shows how the page will look when it is printed.

---

### Creating a Watermark

- 1 To change the print settings from your software application, access printer properties. See "Printing a Document" on page 13.
- 2 Click the **Extras** tab, and click the **Edit** button in the **Watermark** section. The **Edit Watermark** window appears.
- 3 Enter a text message in the **Watermark Message** box. You can enter up to 40 characters. The message displays in the preview window.  
When the **First Page Only** box is checked, the watermark prints on the first page only.
- 4 Select watermark options.  
You can select the font name, style, size, or grayscale level from the **Font Attributes** section and set the angle of the watermark from the **Message Angle** section.
- 5 Click **Add** to add a new watermark to the list.
- 6 When you have finished editing, click **OK** and start printing.

To stop printing the watermark, select **(No Watermark)** from the **Watermark** drop-down list.

## Editing a Watermark

- 1 To change the print settings from your software application, access printer properties. See "Printing a Document" on page 13.
- 2 Click the **Extras** tab and click the **Edit** button in the **Watermark** section. The **Edit Watermark** window appears.
- 3 Select the watermark you want to edit from the **Current Watermarks** list and change the watermark message and options.
- 4 Click **Update** to save the changes.
- 5 Click **OK** until you exit the Print window.

### Deleting a Watermark

- 1 To change the print settings from your software application, access printer properties. See "Printing a Document" on page 13.
- 2 From the **Extras** tab, click the **Edit** button in the Watermark section. The **Edit Watermark** window appears.
- 3 Select the watermark you want to delete from the **Current Watermarks** list and click **Delete**.
- 4 Click **OK** until you exit the Print window.

---

## Using Overlays

### What is an Overlay?



An overlay is text and/or images stored in the computer hard disk drive (HDD) as a special file format that can be printed on any document. Overlays are often used to take the place of preprinted forms and letterhead paper. Rather than using preprinted letterhead, you can create an overlay containing the exact same information that is currently on your letterhead. To print a letter with your company's letterhead, you do not need to load preprinted letterhead paper in the printer. You need only tell the printer to print the letterhead overlay on your document.

### Creating a New Page Overlay

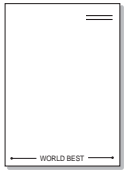

To use a page overlay, you must create a new page overlay containing your logo or image.

- 1 Create or open a document containing text or an image for use in a new page overlay. Position the items exactly as you wish them to appear when printed as an overlay.
- 2 To save the document as an overlay, access printer properties. See "Printing a Document" on page 13.
- 3 Click the **Extras** tab, and click **Edit** button in the **Overlay** section.
- 4 In the Edit Overlay window, click **Create Overlay**.
- 5 In the Create Overlay window, type a name of up to eight characters in the **File name** box. Select the destination path, if necessary. (The default is C:\Formover).
- 6 Click **Save**. The name appears on the **Overlay List** box.
- 7 Click **OK** or **Yes** to finish creating.  
The file is not printed. Instead it is stored on your computer hard disk drive.

---

**NOTE:** The overlay document size must be the same as the documents you print with the overlay. Do not create an overlay with a watermark.

---

## Using a Page Overlay

After an overlay has been created, it is ready to be printed with your document. To print an overlay with a document:

- 1 Create or open the document you want to print.
- 2 To change the print settings from your software application, access printer properties. See "Printing a Document" on page 13.
- 3 Click the **Extras** tab.
- 4 Select the desired overlay from the **Overlay** drop-down list box.
- 5 If the overlay file you want does not appear in the **Overlay** list, click **Edit** button and **Load Overlay**, and select the overlay file.  
If you have stored the overlay file you want to use in an external source, you can also load the file when you access the **Load Overlay** window.  
After you select the file, click **Open**. The file appears in the **Overlay List** box and is available for printing. Select the overlay from the **Overlay List** box.
- 6 If necessary, click **Confirm Page Overlay When Printing**. If this box is checked, a message window appears each time you submit a document for printing, asking you to confirm your wish to print an overlay on your document.  
If this box is not checked and an overlay has been selected, the overlay automatically prints with your document.
- 7 Click **OK** or **Yes** until printing begins.  
The selected overlay downloads with your print job and prints on your document.

---

**NOTE:** The resolution of the overlay document must be the same as that of the document you will print with the overlay.

---

## Deleting a Page Overlay

You can delete page overlays that you no longer use.

- 1 In the printer properties window, click the **Extras** tab.
- 2 Click the **Edit** button in the **Overlay** section.
- 3 Select the overlay you want to delete from the **Overlay List** box.
- 4 Click **Delete Overlay**.
- 5 When a confirming message window appears, click **Yes**.
- 6 Click **OK** until you exit the Print window.

# 4 Using Windows PostScript Driver

If you want to use the PostScript driver provided with your system CD-ROM to print a document.

PPDs, in combination with the PostScript driver, access printer features and allow the computer to communicate with the printer. An installation program for the PPDs is provided on the supplied software CD-ROM.

---

## Printer Settings

You can use the printer properties window, which allows you to access all of the printer options you need when using your printer. When the printer properties are displayed, you can review and change the settings needed for your print job.

Your printer properties window may differ, depending on your operating system. This Software User's Guide shows the Properties window for Windows XP.

Your printer driver **Properties** window that appears in this User's Guide may differ depending on the printer in use.

---

### NOTES:

- Most Windows applications will override settings you specify in the printer driver. Change all print settings available in the software application first, and change any remaining settings using the printer driver.
  - The settings you change remain in effect only while you are using the current program. **To make your changes permanent**, make them in the Printers folder.
  - The following procedure is for Windows XP. For other Windows OS, refer to the corresponding Windows User's Guide or online help.
    1. Click the Windows **Start** button.
    2. Select **Printers and Faxes**.
    3. Select **your printer driver icon**.
    4. Right-click on the printer driver icon and select **Printing Preferences**.
    5. Change the settings on each tab, click OK.
- 

## Advanced

You can use advanced settings by clicking the **Advanced** button.

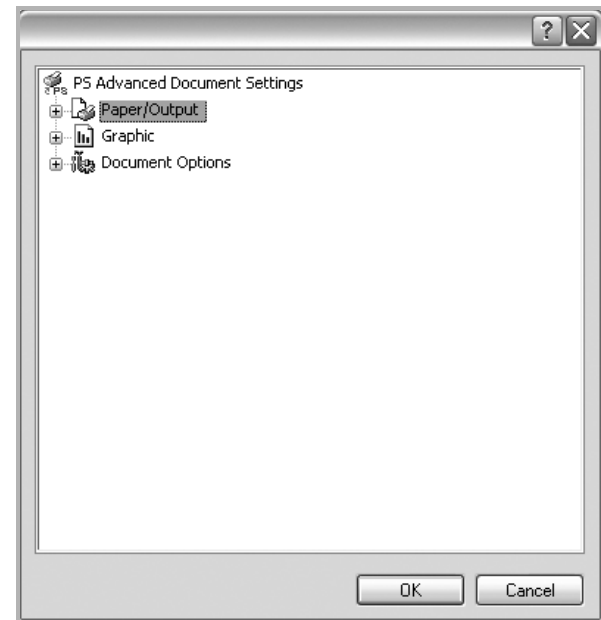

- **Paper/Output** this option allows you to select the size of the paper loaded in the tray.
- **Graphic** this option allows you to adjust the print quality for your specific printing needs.
- **Document Options** this options allow you to set the PostScript options or printer features.

## Using Help

You can click  from the upper right corner of the window, and then click on any setting.

# 5 Using Direct Printing Utility

This chapter explains how to use Direct Printing Utility to print PDF files without having to open the files.

## CAUTION

- You can not print PDF files that are restricted to print. Deactivate the printing restriction feature, and retry printing.
- You can not print PDF files that are restricted by a password. Deactivate the password feature, and retry printing.
- Depending on how a PDF file was created, it may not be able to be printed using the **Direct Printing Utility** program.
- Depending on the installation of Hard Disk on your printer; PDF files can or can not be printed using the **Direct Printing Utility** program.
- The **Direct Printing Utility** program supports PDF version 1.4 and below. For a higher version, you must open the file to print it.

## Overview Direct Printing Utility

Direct Printing Utility is a program that sends a PDF file directly to your printer without having to open the file. It sends data through the Windows spooler using the port of the printer driver. It only supports PDF format.

To installing this program, you should select **Custom installation** and put a check mark in this program when you install the printer driver.

## Printing

There are several ways you can print using Direct Printing Utility.

### From the Direct Printing Utility window

- 1 From the **Start** menu select **Programs** or **All Programs** → **Direct Printing Utility** → **Direct Printing Utility**.  
Or, double-click the Direct Printing Utility shortcut icon on your desk top.  
The Direct Printing Utility window opens.
- 2 Select the printer you will use in the Select Printer section and click **Browse**.
- 3 Select the PDF file you will print and click **Open**.  
The PDF file is added in the Select Files section.
- 4 Customize the printer settings for your needs. See the next column.
- 5 Click **Print**.  
The selected PDF file is sent to the printer.

### Using the shortcut icon

- 1 Select the PDF file you will print and by dragging drop it to the Direct Printing Utility shortcut icon on your desk top.  
The selected PDF file is sent to the default printer.

**NOTE :** If the default printer does not support Direct Printing Utility, the message window alerting you to select the appropriate printer opens. Select the appropriate printer in the Select Printer section.

- 2 Customize the printer settings for your needs.
- 3 Click **Print**.  
The selected PDF file is sent to the printer.

### Using the right-click menu

- 1 Right-click on the PDF file you will print and select **Direct Printing**.  
The Direct Printing Utility window opens with the PDF file is added.
- 2 Select the printer you will use.
- 3 Customize the printer settings for your needs. See the below part.
- 4 Click **Print**.  
The selected PDF file is sent to the printer.

# 6 Sharing the Printer Locally

You can connect the printer directly to a selected computer, which is called “host computer,” on the network.

The following procedure is for Windows XP. For other Windows OS, refer to the corresponding Windows User's Guide or online help.

---

**NOTES:**

- Check the Operating System(s) that are compatible with your printer. Please refer to the OS Compatibility section of Printer Specifications in your Printer User's Guide.
  - If you need to know the exact name of your printer, you can check the supplied CD-ROM.
- 

---

## Setting Up a Host Computer

- 1 Start Windows.
  - 2 From the **Start** menu select **Printers and Faxes**.
  - 3 Double-click **your printer driver icon**.
  - 4 From the **Printer** menu, select **Sharing**.
  - 5 Check the **Share this printer** box.
  - 6 Fill in the **Shared Name** field, and then click **OK**.
- 

## Setting Up a Client Computer

- 1 Right-click the Windows **Start** button and select **Explore**.
- 2 Select **My Network Places** and then right-click **Search for Computers**.
- 3 Fill in the IP address of host computer in **Computer name** field, and click **Search**. (In case host computer requires **User name** and **Password**, fill in User ID and password of host computer account.)
- 4 Double-click **Printers and Faxes**.
- 5 Right-click printer driver icon, select **Connect**.
- 6 Click **Yes**, if the installation confirm message appears.



# 7 Scanning

Scanning with your machine lets you turn pictures and text into digital files on your computer. Then you can fax or e-mail the files, display them on your web site or use them to create projects that you can print using Samsung SmarThru software or the WIA driver.

This chapter includes:

- Scanning Using Samsung SmarThru Office
- Scanning Process with TWAIN-enabled Software
- Scanning Using the WIA Driver

## NOTES:

- *Check the Operating System(s) that are compatible with your printer. Please refer to the OS Compatibility section of Printer Specifications in your Printer User's Guide.*
- *You can check your printer name in the supplied CD-ROM.*
- *The maximum resolution that can be achieved depends upon various factors, including computer speed, available disk space, memory, the size of the image being scanned, and bit depth settings. Thus, depending on your system and what you are scanning, you may not be able to scan at certain resolutions, especially using enhanced dpi.*

## Scanning Using Samsung SmarThru Office

Samsung **SmarThru Office** is the accompanying software for your machine. You can use **SmarThru Office** to scan images or documents from local or network scanners.

### Using Samsung SmarThru Office

Follow these steps to start scanning using the **SmarThru Office**:

- 1 Make sure that your machine and computer are turned on and properly connected to each other.
- 2 Place your photograph or page on the document glass or DADF (or ADF).
- 3 Once you have installed Samsung **SmarThru Office**, you will see the **SmarThru Office** icon on your desktop. Double-click the **SmarThru Office** icon.



Double-click this icon.

The **SmarThru Office** window opens.

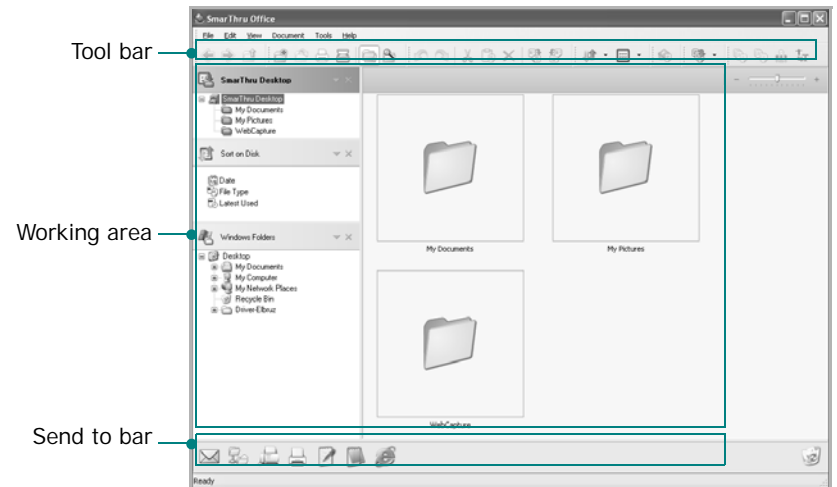

- **Tool bar**: Allows you to use shortcut icons which activate the certain functions such as **Scan**, **Search**, etc.

### • Working area

- **SmarThru Desktop:** Created within the standard Windows folder My Documents.
- **Sort on Disk:** Files of the folders which are not indexed will not be displayed in the **Sort on Disk** section. Sort type are Date, File Types, Latest Used. To add a folder for indexing, press **Edit** menu → **Preferences** → **Index**. It may take longer time to show the added file folders according to the computer performance and the number of added file folders.

### NOTES:

- To do indexing and searching the PDF format file, you must install Adobe Acrobat Reader 7.0.5 or higher.
- You can use indexing and searching functions using **SmarThru Office** supported by Microsoft Indexing Service.

- **Windows Folders:** Allow user to navigate through all the user's files and folders.
- The right panel: Reflects the content of a selected folder.
- **Send to bar:** Run the corresponding application directly. Drag and drop selected files to the appropriate application button.
  - **Send by E-mail:** To send documents by E-mail while working within the **SmarThru Office**. To send scanned images or documents by e-mail, you must have a mail client program, like Outlook Express, which has been set up with your e-mail account.
  - **Send by FTP:** To upload a document file to server while working within the **SmarThru Office**.
  - **Send by Fax:** To send documents by Local or Network fax machine while working within the **SmarThru Office**.

- 4 Click **Scan** on the tool bar of **SmarThru Office** window.

Adjust the scan settings.

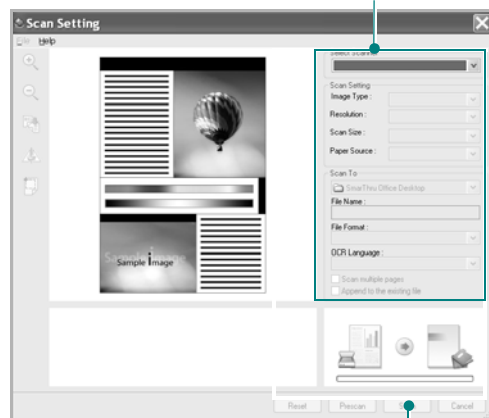

Click to start scanning.

### NOTES:

- In Windows XP operating system, you can use **SmarThru Office** launcher, which is on the right end of taskbar, to open the **Scan Setting** window easily.



- In other operating systems beside Windows XP, click the SmarThru icon  in the tray area of the windows taskbar to activate the **SmarThru Office** launcher.



**Scan Setting** lets you use the following services:

- **Select Scanner:** Select the Local or Network scanner.
  - Local Scan: After scanning with parallel port or USB port, you can store the scanned output in image or document file.
  - Network Scan: After scanning via network, you can store the scanned output in JPEG, TIFF, or pdf file. To use network scanner, your computer should install the **Samsung Network Scan Manager** and register the scanner within that program. Refer to Scanning chapter in user's guide.
- **Scan Settings:** Allows you to customize settings for Image type, Resolution, Scan Size, Paper Source.
- **Scan To:** Allows you to customize settings for File Name, File Format, OCR Language.

- 5 To start scanning, click **Scan**.

**NOTE:** If you want to cancel the scan job, click **Cancel**.

## Uninstalling Samsung SmarThru Office

**NOTE:** Before beginning uninstallation, ensure that all applications are closed on your computer.

- 1 From the **Start** menu, select **Programs**.
- 2 Select **SmarThru Office**, and then select **Uninstall SmarThru Office**.
- 3 When your computer asks you to confirm, read the statement and click **OK**.
- 4 Click **Finish**.

## Using Onscreen Help File

For more information about SmarThru, click  at the top right corner of the window. The SmarThru Help window opens and allows you to view onscreen help supplied on the SmarThru program.

---

## Scanning Process with TWAIN-enabled Software

If you want to scan documents using other software, you will need to use TWAIN-compliant software, such as Adobe Photoshop. The first time you scan with your machine, select it as your TWAIN source in the application you use.

The basic scanning process involves a number of steps:

- 1 Make sure that your machine and computer are turned on and properly connected to each other.
- 2 Load the document(s) face up into the DADF (or ADF).  
OR  
Place a single document face down on the document glass.
- 3 Open an application, such as Photoshop.
- 4 Open the TWAIN window and set the scan options.
- 5 Scan and save your scanned image.

---

**NOTE:** You need to follow the program's instructions for acquiring an image. Please refer to the user's guide of the application.

---

---

## Scanning Using the WIA Driver

Your machine also supports the Windows Image Acquisition (WIA) driver for scanning images. WIA is one of the standard components provided by Microsoft® Windows® XP and works with digital cameras and scanners. Unlike the TWAIN driver, the WIA driver allows you to scan and easily manipulate images without using additional software.

---

**NOTE:** The WIA driver works only on Windows XP/Server 2003/Vista/7 with USB port.

---

## Windows XP/Server 2003

- 1 Load the document(s) face up into the DADF (or ADF).  
OR  
Place a single document face down on the document glass.
- 2 From the **Start** menu on your desktop window, select **Settings, Control Panel**, and then **Scanners and Cameras**.
- 3 Double click **your scanner driver** icon. The Scanner and Camera Wizard launches.
- 4 Choose your scanning preferences and click **Preview** to see how your preferences affect the picture.
- 5 Click **Next**.
- 6 Enter a picture name, and select a file format and destination to save the picture.
- 7 Follow the on-screen instructions to edit the picture after it is copied to your computer.

## Windows Vista

- 1 Load the document(s) face up into the DADF (or ADF).  
OR  
Place a single document face down on the document glass.
- 2 Click **Start** → **Control Panel** → **Hardware and Sound** → **Scanners and Cameras**.
- 3 Click on **Scan a document or picture**. Then **Windows Fax and Scan** application is opened automatically.

---

**NOTE:** To view scanners, user can click on **View scanners and cameras**. If there is not **Scan a document or picture**, open the MS paint program and click From **View scanners and cameras...** on the **File** menu

---

- 4 Click **Scan** and then scan driver is opened.
- 5 Choose your scanning preferences and click **Preview** to see your preferences affect the picture.
- 6 Click **Scan**.

---

**NOTE:** If you want to cancel the scan job, press the Cancel button on the Scanners and Cameras Wizard.

---

## Windows 7

- 1 Load the document(s) face up into the DADF (or ADF).  
OR  
Place a single document face down on the document glass.
- 2 Click **Start** → **Control Panel** → **Hardware and Sound** → **Devices and Printers**.
- 3 Click right button of mouse on device driver icon in **Printers and Faxes** → **Start Scan. New Scan** application appears.
- 4 Choose your scanning preferences and click **Preview** to see your preferences affect the picture.
- 5 Click **Scan**.

# 8 Using Smart Panel

Smart Panel is a program that monitors and informs you of the status of the printer, and allows you to customize the printer's settings. If you are a Windows or Macintosh OS user, Smart Panel is installed automatically when you install the printer software. If you are a Linux OS user, download Smart Panel from the Samsung website ([www.samsung.com/printer](http://www.samsung.com/printer)) and install.

## NOTES:

- To use this program, you need:
  - To check for Operating System(s) that are compatible with your printer, refer to Printer Specifications in your Printer User's Guide.
  - Mac OS X 10.3 or higher
  - Linux. To check for Linux systems that are compatible with your printer, refer to Printer Specifications in your Printer User's Guide.
  - Internet Explorer version 5.0 or higher for flash animation in HTML Help.
- If you need to know the exact name of your printer, you can check the supplied CD-ROM.

## Understanding Smart Panel

If an error occurs while printing, Smart Panel appears automatically, showing the error.

You can also launch Smart Panel manually. Double-click the Smart Panel icon on the Windows task bar (in Windows), or Notification Area (in Linux). You can also click it on the status bar (in Mac OS X).

Double-click this icon in Windows.

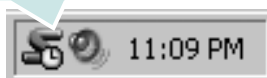

Click this icon in Mac OS X.



Click this icon in Linux.



If you are a Windows user, from the **Start** menu, select **Programs** or **All Programs** → **your printer driver name** → **Smart Panel**.

## NOTES:

- If you have already installed more than one Samsung printer, first select the printer model you want in order to use the corresponding Smart Panel. Right-click (in Windows or Linux) or click (in Mac OS X) the Smart Panel icon and select **your printer name**.
- The Smart Panel window and its contents shown in this Software User's Guide may differ depending on the printer or Operating System in use.

The Smart Panel program displays the current status of the printer, the level of toner remaining in the toner cartridge(s) and various other information. You can also change settings.

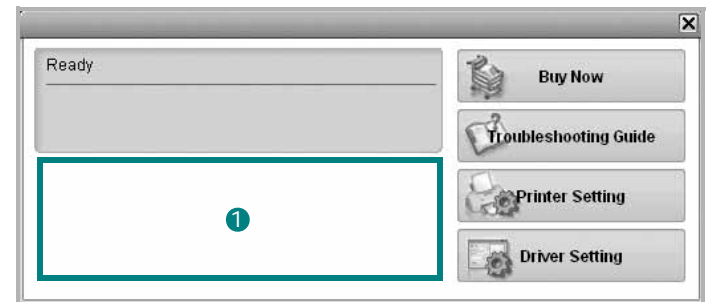

### 1 Toner Level

You can view the level of toner remaining in the toner cartridge(s). The printer and the number of toner cartridge(s) shown in the above window may differ depending on the printer in use. Any printers do not have this feature.

### Buy Now

You can order replacement toner cartridge(s) online.

### Troubleshooting Guide

You can view Help to solve problems.

### Driver Setting (Only for Windows)

You can use the printer properties window, which allows you to access all of the printer options you need for using your printer. For details, See "Printer Settings" on page 14.

---

## Opening the Troubleshooting Guide

Using the troubleshooting guide, you can view solutions for error status problems.

Right-click (in Windows or Linux) or click (in Mac OS X) the Smart Panel icon and select **Troubleshooting Guide**.

---

## Changing the Smart Panel Program Settings

Right-click (in Windows or Linux) or click (in Mac OS X) the Smart Panel icon and select **Options**.

Select the settings you want from the **Options** window.



# 9 Using Your Printer in Linux

You can use your machine in a Linux environment.

This chapter includes:

- **Getting Started**
- **Installing the Unified Linux Driver**
- **Using the Unified Driver Configurator**
- **Configuring Printer Properties**
- **Printing a Document**
- **Scanning a Document**

## Getting Started

You need to download Linux software package from the Samsung website ([www.samsung.com/printer](http://www.samsung.com/printer)) to install the printer softwares.

Samsung's Unified Linux Driver package contains printer and scanner drivers, providing the ability to print documents and scan images. The package also delivers powerful applications for configuring your machine and further processing of the scanned documents.

After the driver is installed on your Linux system, the driver package allows you to monitor a number of machine devices via fast ECP parallel ports and USB simultaneously.

The acquired documents can then be edited, printed on the same local or network machine devices, sent by e-mail, uploaded to an FTP site, or transferred to an external OCR system.

## Installing the Unified Linux Driver

### Installing the Unified Linux Driver

- 1 Make sure that you connect your machine to your computer. Turn both the computer and the machine on.
- 2 When the Administrator Login window appears, type in *root* in the Login field and enter the system password.

**NOTE:** You must log in as a super user (root) to install the printer software. If you are not a super user, ask your system administrator.

- 3 From the Samsung website, download and unpack the Unified Linux Driver package to your computer.
- 4 Right click the **Unified Linux Driver** package and extract the package.
- 5 Double click **cdroot > autorun**.
- 6 When the welcome screen appears, click **Next**.

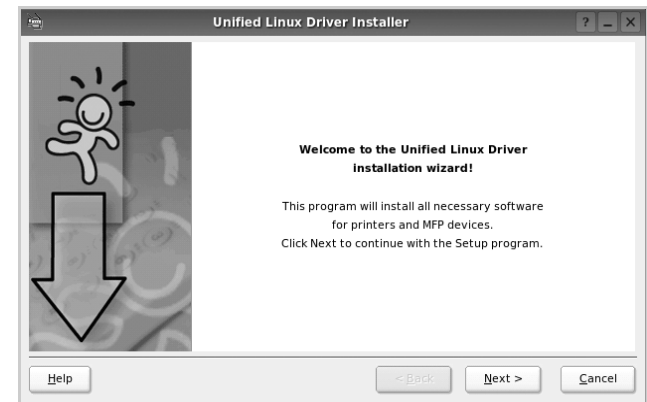

- 7 When the installation is complete, click **Finish**.  
The installation program has added the Unified Driver Configurator desktop icon and Samsung Unified Driver group to the system menu for your convenience. If you have any difficulties, consult the onscreen help that is available through your system menu or can otherwise be called from the driver package windows applications, such as **Unified Driver Configurator** or **Image Manager**.

### Installing the SmartPanel

- 1 Make sure that the machine is connected to your computer and powered on.

- 2 When the **Administrator Login** window appears, type in `root` in the Login field and enter the system password.

---

**NOTE:** You must log in as a super user (`root`) to install the printer software. If you are not a super user, ask your system administrator.

---

- 3 From the Samsung website, download the **Smart Panel** package to your computer.
- 4 Right click the Smart Panel package and extract the package.
- 5 Double click `cdroot > Linux > smartpanel > install.sh`.

## Uninstalling the Unified Linux Driver

- 1 Make sure that the machine is connected to your computer and powered on.
- 2 When the **Administrator Login** window appears, type in `root` in the Login field and enter the system password.

---

**NOTE:** You must log in as a super user (`root`) to uninstall the printer software. If you are not a super user, ask your system administrator.

---

- 3 Click the icon at the bottom of the desktop. When the Terminal screen appears, type in:  
`[root@localhost root]#cd /opt/Samsung/mfp/uninstall/[root@localhost uninstall]#./uninstall.sh`
- 4 Click **Uninstall**.
- 5 Click **Next**.
- 6 Click **Finish**.

## Using the Unified Driver Configurator

Unified Linux Driver Configurator is a tool primarily intended for configuring Printer or MFP devices. Since an MFP device combines the printer and scanner, the Unified Linux Driver Configurator provides options logically grouped for printer and scanner functions. There is also a special MFP port option responsible for the regulation of access to an MFP printer and scanner via a single I/O channel.

After installing the Unified Linux driver, the Unified Linux Driver Configurator icon will automatically be created on your desktop.

## Opening the Unified Driver Configurator

- 1 Double-click **Unified Driver Configurator** on the desktop.  
You can also click the Startup Menu icon and select **Samsung Unified Driver** and then **Unified Driver Configurator**.
- 2 Press each button on the Modules pane to switch to the corresponding configuration window.

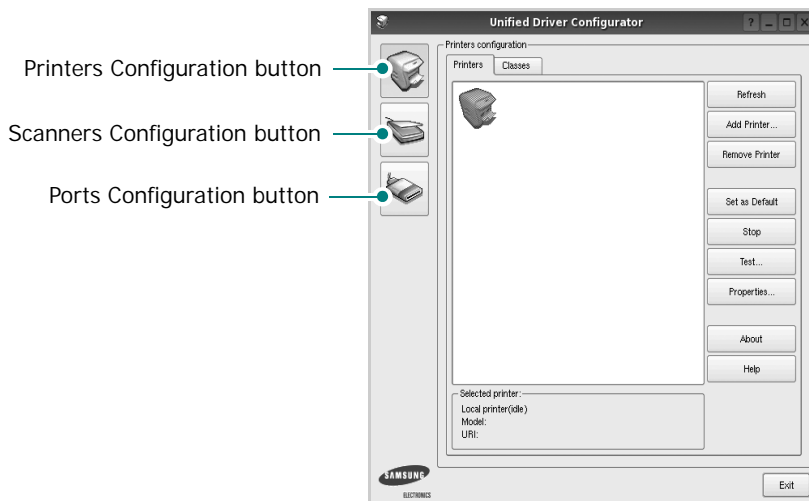

You can use the onscreen help by clicking **Help**.

- 3 After changing the configurations, click **Exit** to close the Unified Driver Configurator.

## Printers Configuration

Printers configuration has the two tabs: **Printers** and **Classes**.

### Printers Tab

You can see the current system's printer configuration by clicking on the printer icon button on the left side of the Unified Driver Configurator window.

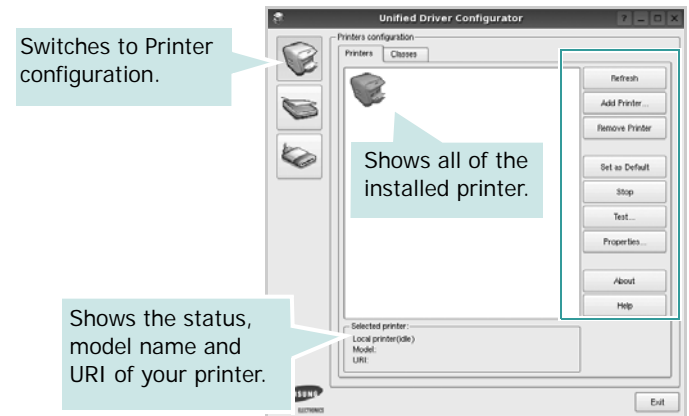

You can use the following printer control buttons:

- **Refresh:** renews the available printers list.
- **Add Printer:** allows you to add a new printer.
- **Remove Printer:** removes the selected printer.
- **Set as Default:** sets the current printer as a default printer.
- **Stop/Start:** stops/starts the printer.
- **Test:** allows you to print a test page to check if the machine is working properly.
- **Properties:** allows you to view and change the printer properties. For details, see page 37.

## Classes Tab

The Classes tab shows a list of available printer classes.

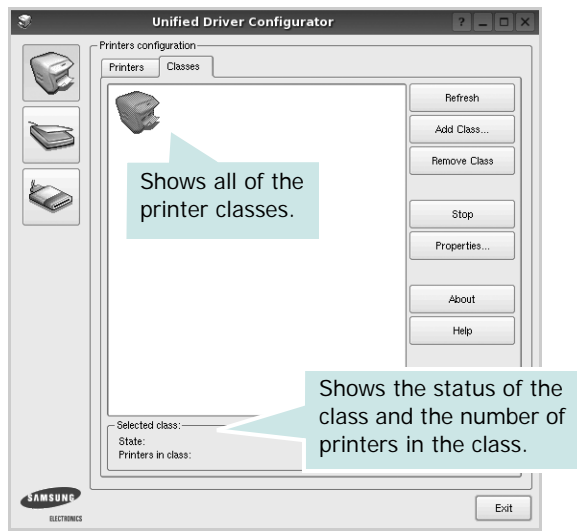

- **Refresh** : Renews the classes list.
- **Add Class...** : Allows you to add a new printer class.
- **Remove Class** : Removes the selected printer class.

## Scanners Configuration

In this window, you can monitor the activity of scanner devices, view a list of installed Samsung MFP devices, change device properties, and scan images.

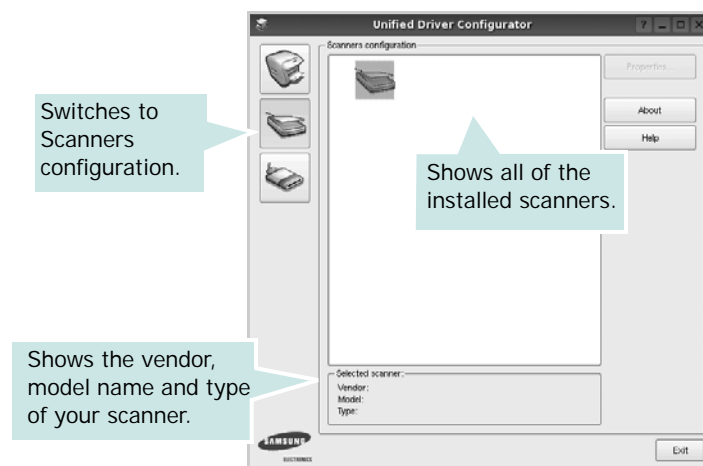

- **Properties...** : Allows you to change the scan properties and scan a document. See page 38.
- **Drivers...** : Allows you to monitor the activity of the scan drivers.

## Ports Configuration

In this window, you can view the list of available ports, check the status of each port and release a port that is stalled in busy state when its owner is terminated for any reason.

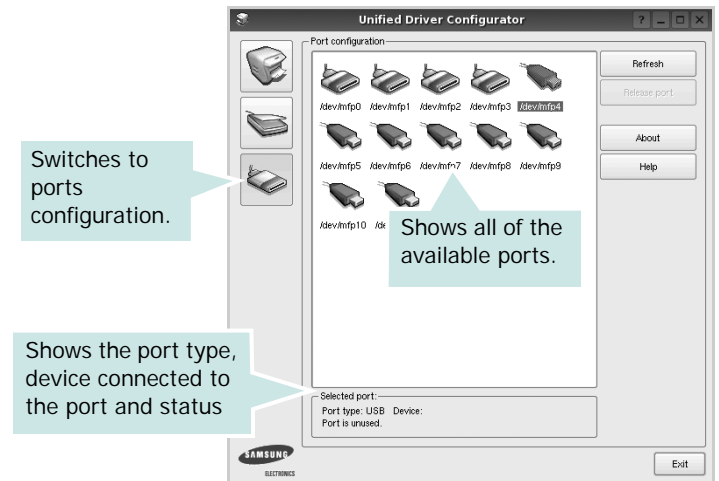

- **Refresh** : Renews the available ports list.
- **Release port** : Releases the selected port.

## Sharing Ports Between Printers and Scanners

Your machine may be connected to a host computer via the parallel port or USB port. Since the MFP device contains more than one device (printer and scanner), it is necessary to organize proper access of "consumer" applications to these devices via the single I/O port.

The Samsung Unified Linux Driver package provides an appropriate port sharing mechanism that is used by Samsung printer and scanner drivers. The drivers address their devices via so-called MFP ports. The current status of any MFP port can be viewed via the Ports Configuration. The port sharing prevents you from accessing one functional block of the MFP device, while another block is in use.

When you install a new MFP device onto your system, it is strongly recommended you do this with the assistance of an Unified Driver Configurator. In this case you will be asked to choose I/O port for the new device. This choice will provide the most suitable configuration for MFP's functionality. For MFP scanners I/O ports are being chosen by scanner drivers automatically, so proper settings are applied by default.

## Configuring Printer Properties

Using the properties window provided by the Printers configuration, you can change the various properties for your machine as a printer.

- 1 Open the Unified Driver Configurator.  
If necessary, switch to Printers configuration.
- 2 Select your machine on the available printers list and click **Properties**.
- 3 The Printer Properties window opens.

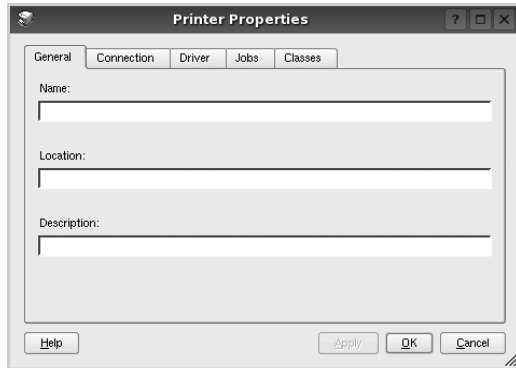

The following five tabs display at the top of the window:

- **General:** allows you to change the printer location and name. The name entered in this tab displays on the printer list in Printers configuration.
  - **Connection:** allows you to view or select another port. If you change the printer port from USB to parallel or vice versa while in use, you must re-configure the printer port in this tab.
  - **Driver:** allows you to view or select another printer driver. By clicking **Options**, you can set the default device options.
  - **Jobs:** shows the list of print jobs. Click **Cancel job** to cancel the selected job and select the **Show completed jobs** check box to see previous jobs on the job list.
  - **Classes:** shows the class that your printer is in. Click **Add to Class** to add your printer to a specific class or click **Remove from Class** to remove the printer from the selected class.
- 4 Click **OK** to apply the changes and close the Printer Properties Window.

## Printing a Document

### Printing from Applications

There are a lot of Linux applications that you are allowed to print from using Common UNIX Printing System (CUPS). You can print on your machine from any such application.

- 1 From the application you are using, select **Print** from the **File** menu.
- 2 Select **Print** directly using **lpr**.
- 3 In the LPR GUI window, select the model name of your machine from the Printer list and click **Properties**.

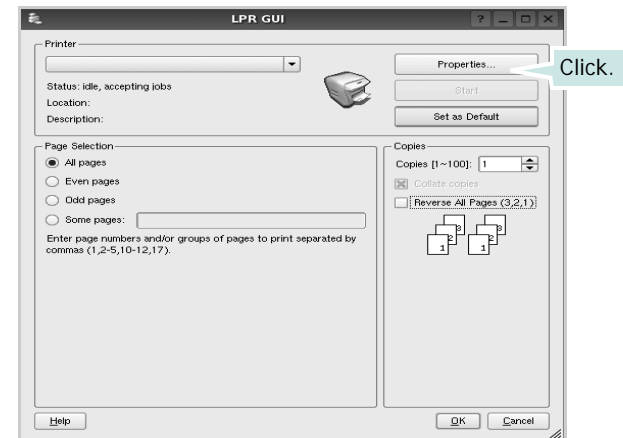

- 4 Change the printer and print job properties.

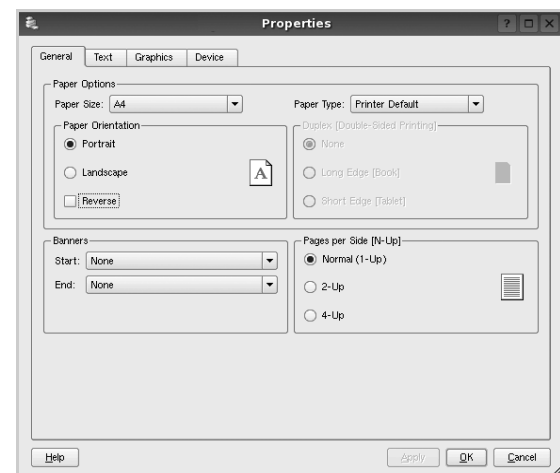

The following four tabs display at the top of the window.

- **General** - allows you to change the paper size, the paper type, and the orientation of the documents, enables the duplex feature, adds start and end banners, and changes the number of pages per sheet.

- **Text** - allows you to specify the page margins and set the text options, such as spacing or columns.
- **Graphics** - allows you to set image options that are used when printing images/files, such as color options, image size, or image position.
- **Device**: allows you to set the print resolution, paper source, and destination.

- 5 Click **Apply** to apply the changes and close the Properties window.
- 6 Click **OK** in the LPR GUI window to start printing.
- 7 The Printing window appears, allowing you to monitor the status of your print job.  
To abort the current job, click **Cancel**.

## Printing Files

You can print many different types of files on the Samsung machine device using the standard CUPS way - directly from the command line interface. The CUPS lpr utility allows you do that. But the drivers package replaces the standard lpr tool by a much more user-friendly LPR GUI program.

To print any document file:

- 1 Type `lpr <file_name>` from the Linux shell command line and press **Enter**. The LPR GUI window appears.  
When you type only `lpr` and press **Enter**, the Select file(s) to print window appears first. Just select any files you want to print and click **Open**.
- 2 In the LPR GUI window, select your printer from the list, and change the printer and print job properties.  
For details about the properties window, see page 37.
- 3 Click **OK** to start printing.

## Scanning a Document

You can scan a document using the Unified Driver Configurator window.

- 1 Double-click the Unified Driver Configurator on your desktop.
- 2 Click the  button to switch to Scanners Configuration.
- 3 Select the scanner on the list.



When you have only one MFP device and it is connected to the computer and turned on, your scanner appears on the list and is automatically selected.

If you have two or more scanners attached to your computer, you can select any scanner to work at any time. For example, while acquisition is in progress on the first scanner, you may select the second scanner, set the device options and start the image acquisition simultaneously.

- 4 Click **Properties**.
- 5 Load the document to be scanned face up into the ADF (Automatic Document Feeder) or face down on the document glass.
- 6 Click **Preview** in the Scanner Properties window.



The document is scanned and the image preview appears in the Preview Pane.

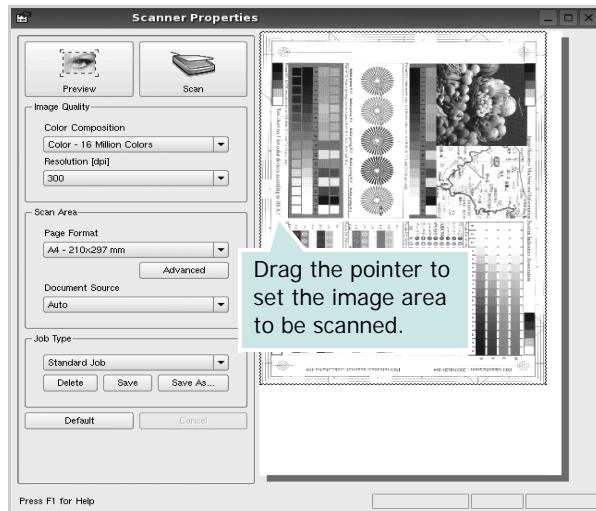

- 7 Change the scan options in the Image Quality and Scan Area sections.

- **Image Quality:** allows you to select the color composition and the scan resolution for the image.
- **Scan Area:** allows you to select the page size. The **Advanced** button enables you to set the page size manually.

If you want to use one of the preset scan option settings, select from the Job Type drop-down list. For details about the preset Job Type settings, see page 39.

You can restore the default setting for the scan options by clicking **Default**.

- 8 When you have finished, click **Scan** to start scanning.

The status bar appears on the bottom left of the window to show you the progress of the scan. To cancel scanning, click **Cancel**.

- 9 The scanned image appears in the new Image Manager tab.

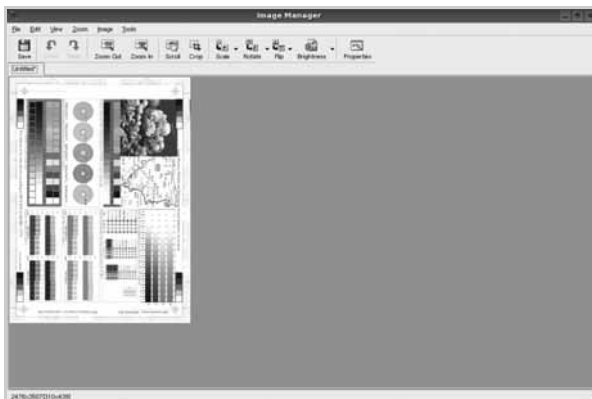

If you want to edit the scanned image, use the toolbar. For further details about editing an image, see page 39.

- 10 When you are finished, click **Save** on the toolbar.
- 11 Select the file directory where you want to save the image and enter the file name.
- 12 Click **Save**.

## Adding Job Type Settings

You can save your scan option settings to retrieve for a later scanning.

To save a new Job Type setting:

- 1 Change the options from the Scanner Properties window.
- 2 Click **Save As**.
- 3 Enter the name for your setting.
- 4 Click **OK**.

Your setting is added to the Saved Settings drop-down list.

To save a Job Type setting for the next scan job:

- 1 Select the setting you want to use from the Job Type drop-down list.
- 2 The next time you open the Scanner Properties window, the saved setting is automatically selected for the scan job.

To delete a Job Type setting:

- 1 Select the setting you want to delete from the Job Type drop-down list.

- 2 Click **Delete**.







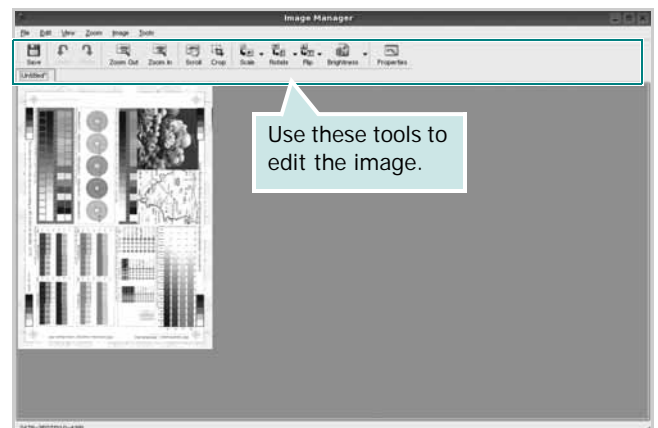





The setting is deleted from the list

## Using the Image Manager

The Image Manager application provides you with menu commands and tools to edit your scanned image.



You can use the following tools to edit the image:

Tools	Function
 Save	Saves the image.
 Undo	Cancels your last action.
 Redo	Restores the action you canceled.
 Scroll	Allows you to scroll through the image.
 Crop	Crops the selected image area.
 Zoom Out	Zooms the image out.
 Zoom In	Zooms the image in.
 Scale	Allows you to scale the image size; you can enter the size manually, or set the rate to scale proportionally, vertically, or horizontally.
 Rotate	Allows you to rotate the image; you can select the number of degrees from the drop-down list.
 Flip	Allows you to flip the image vertically or horizontally.
 Effect	Allows you to adjust the brightness or contrast of the image, or to invert the image.
 Properties	Shows the properties of the image.

For further details about the Image Manager application, refer to the onscreen help.

# 10 Using Your Printer with a Macintosh

Your machine supports Macintosh systems with a built-in USB interface or a 10/100 Base-TX network interface card. When you print a file from a Macintosh computer, you can use the PostScript driver by installing the PPD file.

---

**NOTE:** *Some printers do not support a network interface. Make sure that your printer supports a network interface by referring to Printer Specifications in your Printer User's Guide.*

---

This chapter includes:

- **Installing Software**
- **Uninstalling software**
- **Setting Up the Printer**
- **Printing**
- **Scanning**

---

## Installing Software

The CD-ROM that came with your printer provides you with the PPD file that allows you to use the CUPS driver or Apple LaserWriter driver (*only available when you use a printer which supports the PostScript driver*), for printing on a Macintosh computer.

Also, it provides you with the Twain driver for scanning on a Macintosh computer.

- 1** Make sure that you connect your printer to the computer. Turn on your computer and printer.
- 2** Insert the CD-ROM which came with your printer into the CD-ROM drive.
- 3** Double-click **CD-ROM icon** that appears on your Macintosh desktop.
- 4** Double-click the **MAC\_Installer** folder.
- 5** Double-click the **Installer OS X** icon.
- 6** Enter the password and click **OK**.
- 7** The Samsung Installer window opens. Click **Continue**
- 8** Select **Easy Install** and click **Install**. **Easy Install** is recommended for most users. All components necessary for printer operations will be installed. If you select **Custom Install**, you can choose individual components to install.

- 9** The message which warns all application will close on your computer appears, Click **Continue**.

- 10** After the installation is finished, click **Quit**.
- 

**NOTE:**

- If you have installed scan driver, click **Restart**.
  - After the installation is finished, see "Setting Up the Printer" on page 42
- 

---

## Uninstalling software

Uninstall is required if you are upgrading the software, or if installation fails.

- 1** Make sure that you connect your printer to the computer. Turn on your computer and printer.
- 2** Insert the CD-ROM which came with your printer into the CD-ROM drive.
- 3** Double-click **CD-ROM icon** that appears on your Macintosh desktop.
- 4** Double-click the **MAC\_Installer** folder.
- 5** Double-click the **Installer OS X** icon.
- 6** Enter the password and click **OK**.
- 7** The Samsung Installer window opens. Click **Continue**
- 8** Select **Uninstall** and click **Uninstall**.
- 9** The message which warns all application will close on your computer appears, Click **Continue**.
- 10** When the uninstallation is done, click **Quit**.

---

## Setting Up the Printer

Set up for your printer will be different depending on which cable you use to connect the printer to your computer—the network cable or the USB cable.

### For a Network-connected

---

**NOTE:** *Some printers do not support a network interface. Before connecting your printer, make sure that your printer supports a network interface by referring to Printer Specifications in your Printer User's Guide.*

---

- 1 Follow the instructions on “When the uninstallation is done, click Quit.” on page 41 to install the PPD file on your computer.
- 2 Open the **Applications** folder → **Utilities**, and **Print Setup Utility**.
  - For MAC OS 10.5~10.6, open **System Preferences** from the **Applications** folder, and click **Printer & Fax**.
- 3 Click **Add** on the **Printer List**.
  - For MAC OS 10.5~10.6, press the “+” icon then a display window will pop up.
- 4 For MAC OS 10.3, select the **Rendezvous** tab.
  - For MAC OS 10.4, click **Default Browser** and find the **Bonjour**.
  - For MAC OS 10.5~10.6, click **Default** and find the **Bonjour**.

The name of your machine appears on the list. Select **SEC000xxxxxxxx** from the printer box, where the **xxxxxxxx** varies depending on your machine.
- 5 For MAC OS 10.3, if Auto Select does not work properly, select **Samsung** in **Printer Model** and **your printer name** in **Model Name**.
  - For MAC OS 10.4, if Auto Select does not work properly, select **Samsung** in **Print Using** and **your printer name** in **Model**.
  - For MAC OS 10.5~10.6, if Auto Select does not work properly, select **Select a driver to use...** and **your printer name** in **Print Using**.

Your machine appears on the Printer List and is set as the default printer.
- 6 Click **Add**.

### For a USB-connected

- 1 Follow the instructions on “When the uninstallation is done, click Quit.” on page 41 to install the PPD file on your computer.
- 2 Open the **Applications** folder → **Utilities**, and **Print Setup Utility**.
  - For MAC OS 10.5~10.6, open **System Preferences** from the **Applications** folder, and click **Printer & Fax**.
- 3 Click **Add** on the **Printer List**.
  - For MAC OS 10.5~10.6, press the “+” icon then a display window will pop up.
- 4 For MAC OS 10.3, select the **USB** tab.
  - For MAC OS 10.4, click **Default Browser** and find the USB connection.
  - For MAC OS 10.5~10.6, click **Default** and find the USB connection.
- 5 Select **your printer name**.
- 6 For MAC OS 10.3, if Auto Select does not work properly, select **Samsung** in **Printer Model** and **your printer name** in **Model Name**.
  - For MAC OS 10.4, if Auto Select does not work properly, select **Samsung** in **Print Using** and **your printer name** in **Model**.
  - For MAC OS 10.5~10.6, if Auto Select does not work properly, select **Select a driver to use...** and **your printer name** in **Print Using**.

Your machine appears on the Printer List and is set as the default printer.
- 7 Click **Add**.

# Printing

## NOTES:

- The Macintosh printer's properties window that appears in this User's Guide may differ depending on the printer in use. However the composition of the printer properties window is similar.
- *You can check your printer name in the supplied CD-ROM.*

## Printing a Document

When you print with a Macintosh, you need to check the printer software setting in each application you use. Follow these steps to print from a Macintosh.

- 1 Open a Macintosh application and select the file you want to print.
- 2 Open the **File** menu and click **Page Setup (Document Setup** in some applications).
- 3 Choose your paper size, orientation, scaling, and other options and click **OK**.

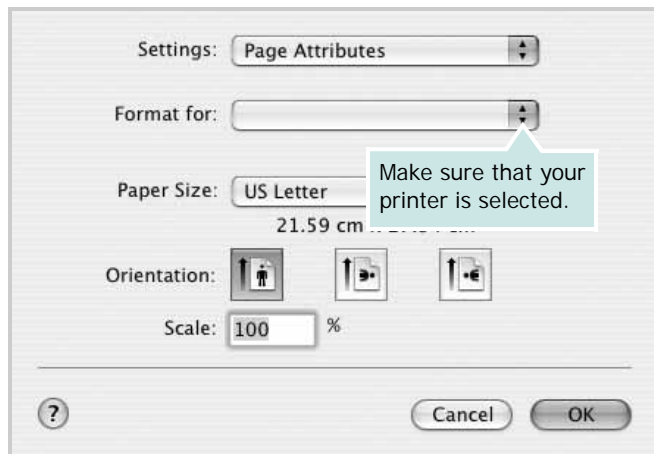

Mac OS 10.3

- 4 Open the **File** menu and click **Print**.
- 5 Choose the number of copies you want and indicate which pages you want to print.
- 6 Click **Print** when you finish setting the options.

## Changing Printer Settings

You can use advanced printing features when using your printer.

From your Macintosh application, select **Print** from the **File** menu. The printer name which appears in the printer properties window may differ depending on the printer in use. Except for the name, the composition of the printer properties window is similar.

**NOTES:** The setting options may differ depending on printers and Macintosh OS version.

## Layout

The **Layout** tab provides options to adjust how the document appears on the printed page. You can print multiple pages on one sheet of paper. Select **Layout** from the **Presets** drop-down list to access the following features.

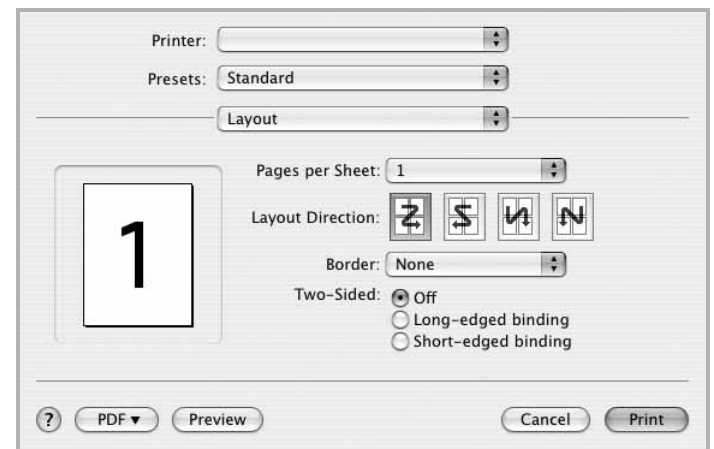

Mac OS 10.4

- **Pages per Sheet:** This feature determines how many pages printed on one page. For details, see "Printing Multiple Pages on One Sheet of Paper" on the next column.
- **Layout Direction:** You can select the printing direction on a page as like the examples on UI.

## Graphics

The **Graphics** tab provides options for selecting **Resolution(Quality)** and **Color Mode**. Select **Graphics** from the **Presets'** drop-down list to access the graphic features.

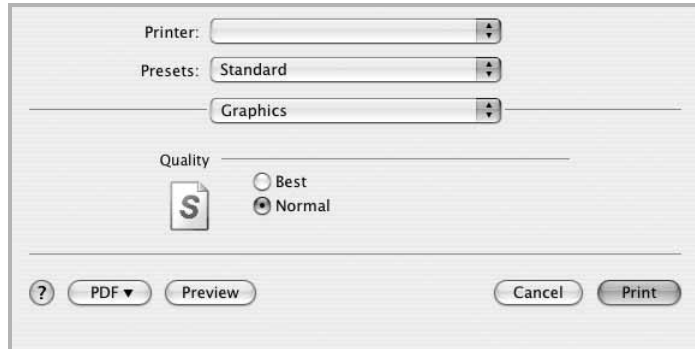

Mac OS 10.4

- **Resolution(Quality):** You can select the printing resolution. The higher the setting, the sharper the clarity of printed characters and graphics. The higher setting also may increase the time it takes to print a document.

## Paper

Set **Paper Type** to correspond to the paper loaded in the tray from which you want to print. This will let you get the best quality printout. If you load a different type of print material, select the corresponding paper type.



Mac OS 10.4

## Printer Features

This tab provides options for selecting the paper type and adjusting print quality. Select **Printer Features** from the **Presets'** drop-down list to access the following features:

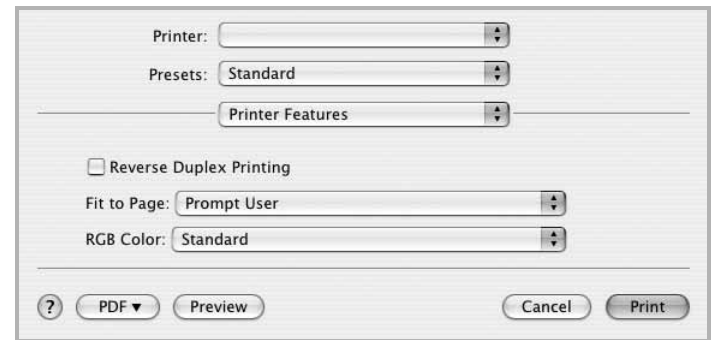

Mac OS 10.4

- **Reverse Duplex Printing:** Allows you to select general print order compare to duplex print order.
- **Fit to Page:** This setting allows you to scale your print job to any selected paper size regardless of the digital document size. This can be useful when you want to check fine details on a small document.



## Printing Multiple Pages on One Sheet of Paper

You can print more than one page on a single sheet of paper. This feature provides a cost-effective way to print draft pages.

- 1 From your Macintosh application, select **Print** from the **File** menu.
- 2 Select **Layout**.

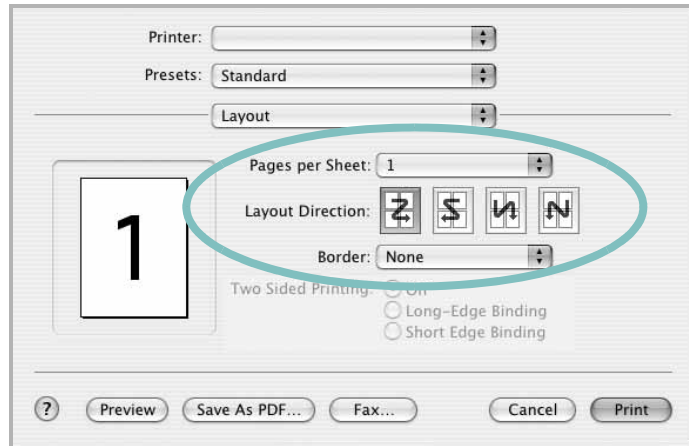

Mac OS 10.3

- 3 Select the number of pages you want to print on one sheet of paper on the **Pages per Sheet** drop-down list.
- 4 Select the page order from the **Layout Direction** option. To print a border around each page on the sheet, select the option you want from the **Border** drop-down list.
- 5 Click **Print**, and the printer prints the selected number of pages on one side of each page.

## Duplex Printing

You can print on both sides of the paper. Before printing in the duplex mode, decide on which edge you will be binding your finished document. The binding options are:

**Long-Edge Binding:** Which is the conventional layout used in book binding.

**Short-Edge Binding:** Which is the type often used with calendars.

- 1 From your Macintosh application, select **Print** from the **File** menu.
- 2 Select the **Layout**.

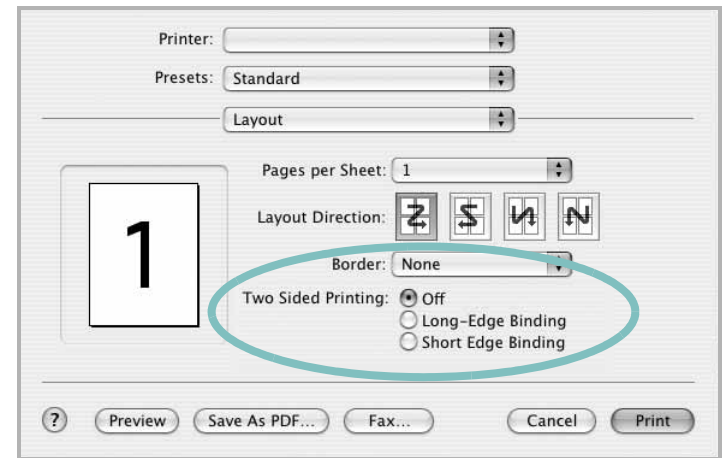

Mac OS 10.3

- 3 Select a binding orientation from **Two Sided Printing** option.
- 4 Click **Print** and the printer prints on both sides of the paper.

---

**CAUTION:** If you have selected duplex printing and then try to print multiple copies of a document, the printer may not print the document in the way you want. In case of "Collated copy", if your document has odd pages, the last page of the first copy and the first page of the next copy will be printed on the front and back of one sheet. In case of "Uncollated copy", the same page will be printed on the front and back of one sheet. Therefore, if you need multiple copies of a document and you want those copies on both sides of the paper, you must print them one at a time, as separate print jobs.

---

---

## Scanning

You can scan documents using **Image Capture**. Macintosh OS offers **Image Capture**.

- 1 Make sure that your machine and computer are turned on and properly connected to each other.
- 2 Load the document(s) face up into the DADF (or ADF). OR place a single document face down on the document glass.
- 3 Start **Applications** and click **Image Capture**.

---

**NOTE:** If **No Image Capture device connected** message appears, disconnect the USB cable and reconnect it. If the problem persists, please refer to the **Image Capture**'s help.

---

- 4 Set the scan options on this program.
- 5 Scan and save your scanned image.

---

**NOTE:**

- For more information about using **Image Capture**, please refer to the **Image Capture**'s help.
  - Use TWAIN-compliant softwares to apply more scan options.
  - You can also scan using TWAIN-compliant softwares, such as Adobe Photoshop.
  - Scan process differ according to TWAIN-compliant softwares. Please refer to the user's guide of the software.
  - When scanning does not operate in **Image Capture**, update Mac OS to the latest version. **Image Capture** operates properly in Mac OS 10.3.9 or higher and Mac OS 10.4.7 or higher.
-

# SOFTWARE SECTION

# INDEX

## A

advanced printing, use 19

## B

booklet printing 20

## C

canceling  
scan 29

## D

document, print  
Macintosh 43  
Windows 13  
double-sided printing 21

## E

Extras properties, set 17

## F

favorites settings, use 18

## G

Graphics properties, set 16

## H

help, use 18, 24

## I

install  
printer driver  
Macintosh 41  
Windows 5  
installing  
Linux software 33

## L

Layout properties, set  
Windows 15  
Linux  
driver, install 33  
printer properties 37  
printing 37  
scanning 38

## M

Macintosh  
driver  
install 41  
uninstall 41  
printing 43  
scanning 46  
setting up the printer 42  
MFP driver, install  
Linux 33

## N

n-up printing  
Macintosh 45  
Windows 19

## O

orientation, print 37  
Windows 15  
overlay  
create 23  
delete 23  
print 23

## P

Paper properties, set 15  
paper size, set 15  
print 37  
paper source, set 38  
Windows 15  
paper tray, set

copy 25  
paper type, set  
print 37  
poster, print 20  
PostScript driver  
installing 24  
print  
document 13  
fit to page 21  
from Macintosh 43  
from Windows 13  
N-up  
Macintosh 45  
Windows 19  
overlay 23  
poster 22  
PRN 14  
scaling 21  
watermark 22  
print resolution 38  
printer driver, install  
Linux 33  
printer properties  
Linux 37  
printer properties, set  
Macintosh 43  
Windows 14, 24  
printer resolution, set  
Windows 16  
printer software  
install  
Macintosh 41  
Windows 5  
uninstall  
Macintosh 41  
Windows 12  
printing  
booklets 20  
double-sided 21  
from Linux 37

## R

resolution  
printing 38

## S

- scanning
  - Linux 38
  - SmarThru 27
  - TWAIN 29
  - WIA driver 29
- scanning from Macintosh 46
- setting
  - darkness 16
  - favorites 18
  - image mode 16
  - resolution
    - Windows 16
  - toner save 16
  - true-type option 16
- software
  - install
    - Macintosh 41
    - Windows 5
  - reinstall
    - Windows 11
  - system requirements
    - Macintosh 41
  - uninstall
    - Macintosh 41
    - Windows 12
- status monitor, use 31

## T

- toner save, set 16
- TWAIN, scan 29

## U

- uninstall, software
  - Macintosh 41
  - Windows 12
- uninstalling
  - MFP driver
  - Linux 34

## W

- watermark
  - create 22
  - delete 22
  - edit 22
  - print 22
- WIA, scan 29